

easicook.co.uk

Spare Parts Manual

**Leading UK Distributors
of Catering Equipment Since 1977**

Sales - Repairs - Spares

Tel: 029 20747567

Fax: 029 20214100

Email: info@easicook.co.uk

Spare parts list



Dish- and glasswashing machines

FV 40.2-MIKE 2

12/2002 - 2007



FV 40.2-M

Inhaltsverzeichnis:	Contents:	Contenu:	Seite/ Page
01.17	Waschpumpe	Pompe de lavage	4
03.23	Waschsystem	Système de lavage	6
04.14	Magnetventil	Electrovanne	7
06.07	Niveauregelung	Régulation de niveau	9
08.36	Einbauboiler	Surchauffeur incorporé	10
09.17	Tankheizung	Chauffage de bac	13
10.16	Dosiergeräte	Doseurs	14
10.19	Dosiergeräte ADT	Doseurs ADT	16
11.40	Elektroniksteuerung	Commande électronique	18
13.28	Baugruppen/Einzelteile	Blocs/Pièces détachées	21
16.04	Einbauwasserenthärter	Adoucisseur incorpore	22
18.11	Laugenpumpe	Pompe de vidange	25
22.14	Drucksteigerungspumpe	Sur presseur	26
24.07	Freier Auslauf	écoulement libre	27
25.01	Türgewichtsausgleich	Equilibrage de poids de porte	29

KENNZEICHNUNG DER ER- SATZTEILE

* / V DIESE TEILE EMPFEHLEN WIR AUF
LAGER ZU LEGEN!

V VERSCHLEISSTEIL!

ÄNDERUNGEN IN AUSFÜHRUNG
UND KONSTRUKTION VORBEHAL-
TEN.

SPECIAL MARKS OF SPARES

WE RECOMMEND TO STORE THESE
PARTS!

WEAR AND TARE PART!

WE RESERVE THE RIGHT TO CHANGE
EXECUTION AND CONSTRUCTION.

MARQUAGE SPECIALES DES PIECES

NOUS RECOMMANDONS DE PRENDRE
CES PIECES EN STOCK!

PIÈCE D'USURE!

NOUS NOUS RESERVONS LE DROIT DE
CHANGER L'EXECUTION ET LA CONS-
TRUCTION.

MEIKO Maschinenbau GmbH & Co. KG

Englerstraße 3

D-77652 Offenburg

Telefon: 0781 / 203 - 0

Telefax: 0781 / 203 - 1274

www.meiko.de

e-mail: info@meiko.de

01.17 WASCHPUMPE

01.17 WASH PUMP

01.17 POMPE DE LAVAGE



PU1_17.doc
01.12.2002/FUS

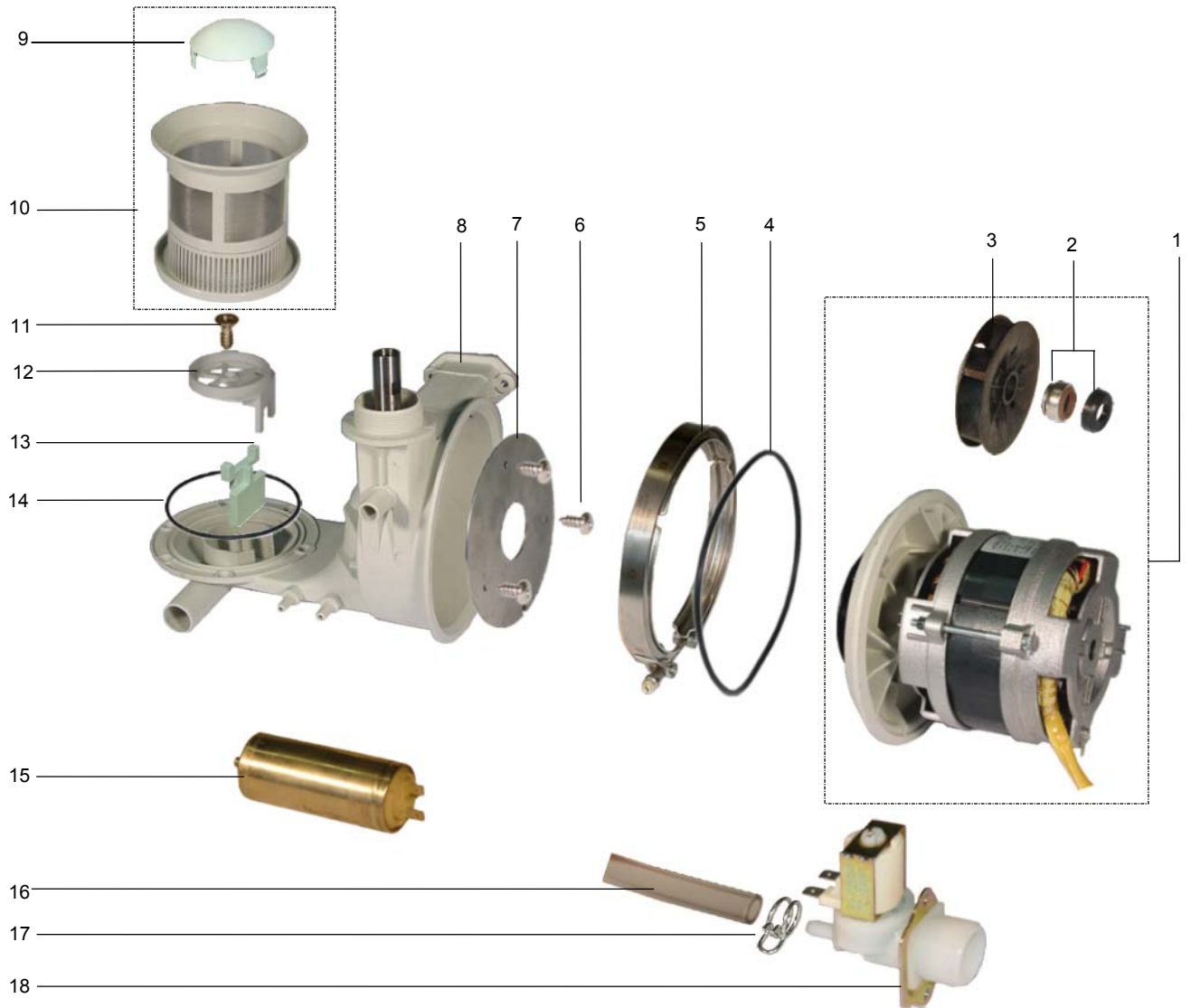

01.17 WASCHPUMPE

01.17 WASH PUMP

01.17 POMPE DE LAVAGE



PU1_17.doc
01.12.2002/FUS

POS	IDENT. NR. IDENT. NO.	BEZEICHNUNG	DESIGNATION	DESIGNATION
1	* 9544294	WASCHPUMPE 0,55 KW KPL.	WASH PUMP 0,55 KW CPL.	POMPE DE LAVAGE 0,55 KW CPL.
2	V 9519539	GLEITRINGDICHTUNG KPL.	SLIDING SEAL CPL.	JOINT AXIAL
3	* 9519529	PUMPENLAUFRAD	PUMP WHEEL	ROUE DE POMPE
4	* 9515339	O-RING	O-RING	BAGUE
5	9519356	PROFILSCHELLE	PROFILE CUP	BRIDE PROFILEE
6	0330020	SCHRAUBE 4,2X13	SCREW 4,2X13	VIS 4,2X13
7	9519224	PUMPENBODEN	PUMP BASE	FOND DE POMP
8	9514632	PUMPENGEHÄUSE	PUMP HOUSING	CORPS DE POMPE
9	9607788	ABDECKKAPPE	COVERING CAP	COUVERCLE
10	* 9611991	ANSAUGSIEB KPL.	SUCTION SIEVE CPL.	FILTRE DE ASPIRATION
11	0330039	SCHRAUBE 4,2X22	SCREW 4,2X22	VIS 4,2X22
12	9600024	ABLAUFVENTIL	DRAIN VALVE	VANNE DE VIDANGE
13	9550670	KLAPPE	FLAP	CLAPET
14	* 9515338	O-RING	O-RING	BAGUE
15	* 0501090	KONDENSATOR	CONDENSER	CONDENSEUR
16	0260007	SCHLAUCH KLARSICHT Ø6	HOSE TRANSPARENTØ6	TUYAU TRANSPARENT Ø6
17	9500045	SCHLAUCHKLEMME GELB	HOSE WIRE CLAMP YELLOW	COLLIER DE SERRAGE JAUNE
18	* 9544641	SANFTANLAUFVENTIL	SMOOTH START VALVE	VALVE POUR DEMARRAGE EN DOUCEUR

03.23 WASCHSYSTEM

03.23 WASH SYSTEM

03.23 SYSTEME DE LAVAGE



01.12.2002/FUS

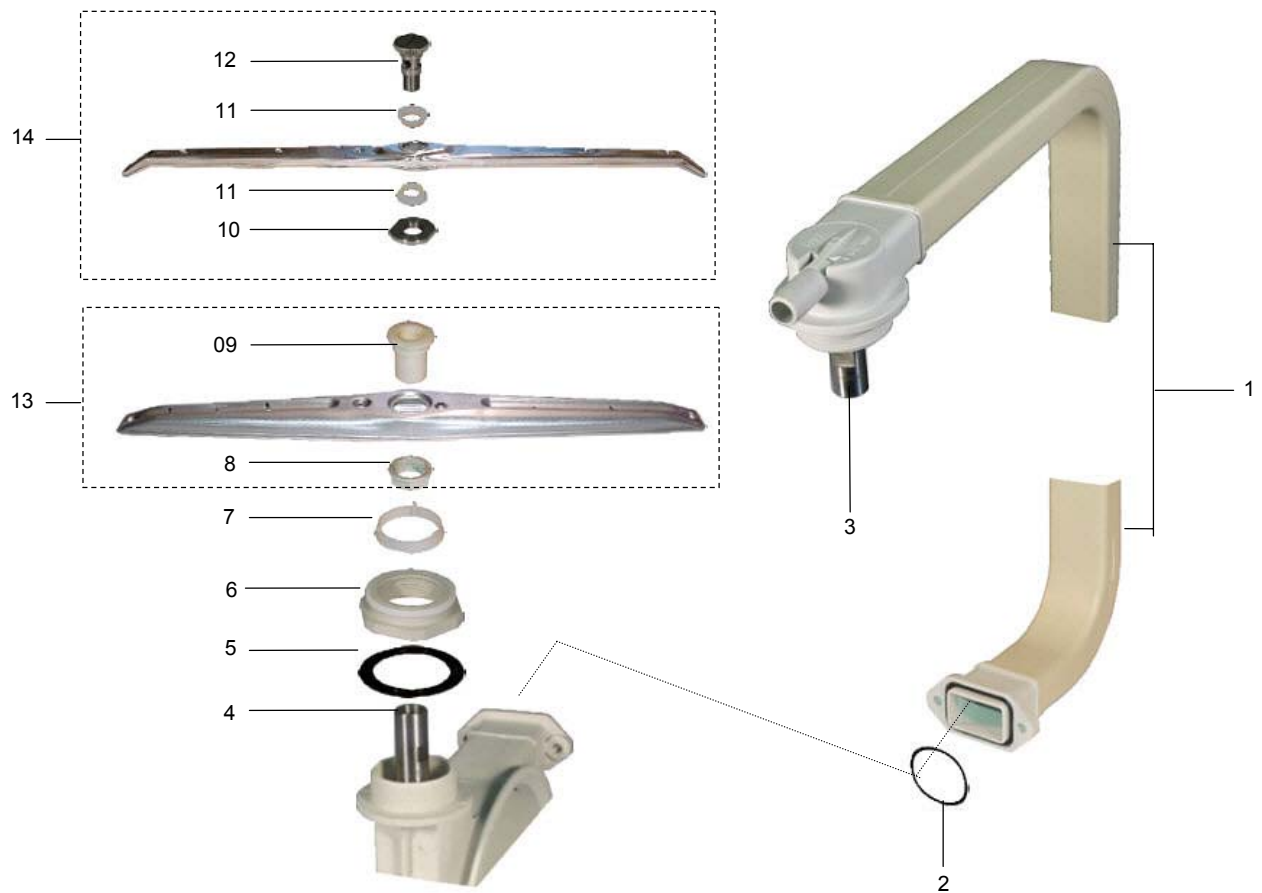

POS	IDENT. NR. IDENT. NO.	BEZEICHUNG	DESIGNATION	DESIGNATION
1	9604980	STEIGROHR	ASCENDING PIPE	COLONNE DE ELEVATION
2	* 9515336	O-RING	O-RING	BAGUE
3	9514452	LAGERZAPFEN OBEN	UPPER BEARING NECK	TOURILLON SUP.
4	9514453	LAGERZAPFEN UNTEN	LOWER BEARING NECK	TOURILLON INF.
5	* 9515334	GUMMIDICHTUNG	PACKING	JOINT
6	* 9514101	MUTTER	NUT	ECROU
7	V 9520931	RING	RING	BAGUE
8	* 9517398	MUTTER	NUT	ECROU
9	V 9517397	LAGER	BEARING	PALIER
10	V 9604483	DISTANZSCHEIBE	DISK	DISQUE
11	V 9522439	LAGER	BEARING	PALIER
12	9517409	RÄNDELSCHRAUBE	KNURLED SCREW	VIS MOLETEE
13	9517391	WASCHARM KPL.	WASH ARM CPL.	BRAS DE LAVAGE CPL.
14	9547257	NACHSPÜLARM KPL.	FINAL RINSE ARM CPL.	BRAS DE RINCAGE FINAL CPL.

04.14 MAGNETVENTIL

04.14 SOLENOID VALVE

04.14 ELECTROVANNE



MV4_14.doc
01.12.2002/FUS

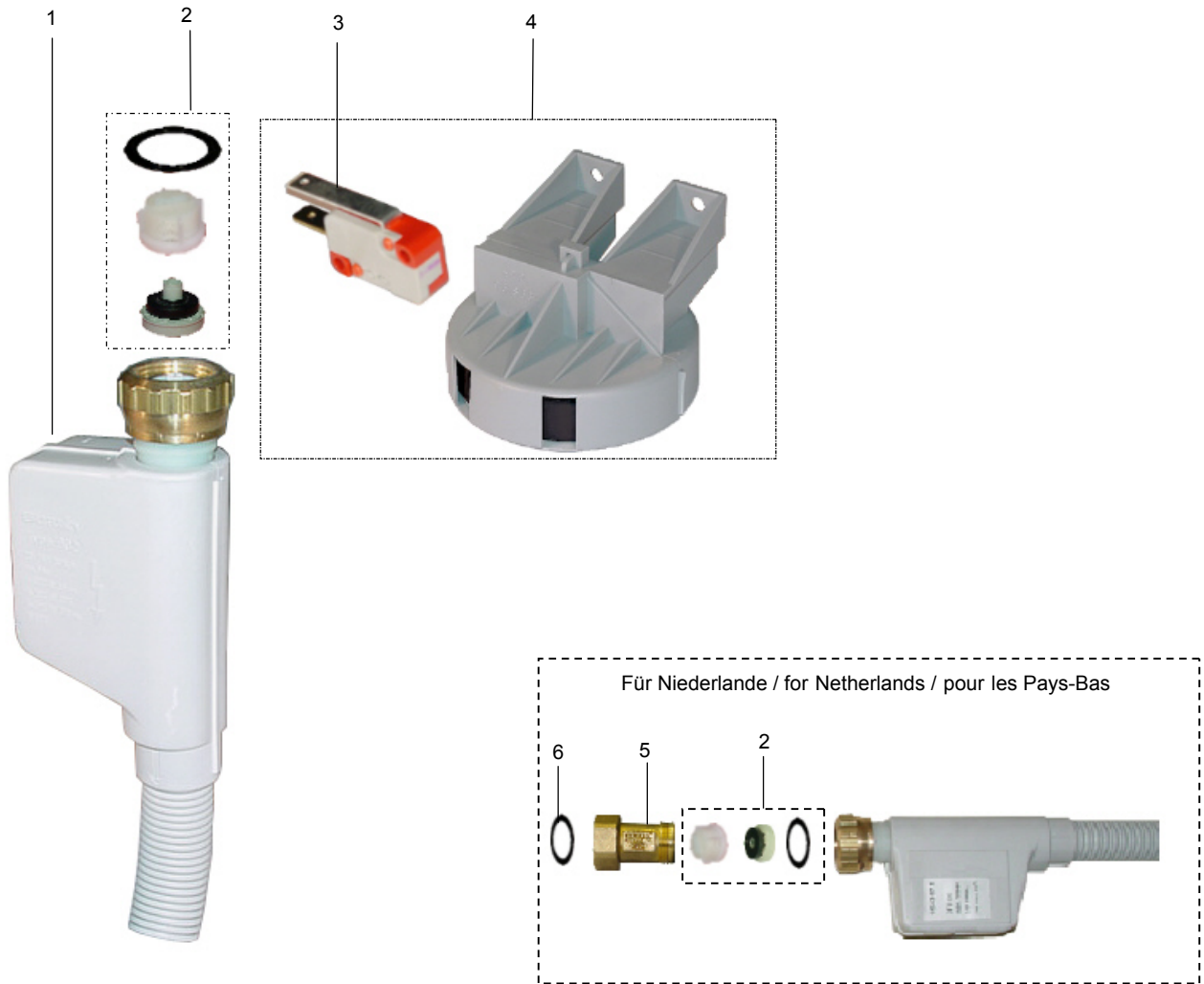

POS	IDENT. NR. IDENT. NO.	BEZEICHUNG	DESIGNATION	DESIGNATION
		FÜR GROSSBRITANNIEN	FOR GREAT BRITAIN	POUR GRANDE-BRETAGNE
1	* 9546090	AQUASTOP SYSTEM WRC 24V	AQUASTOP SYSTEM WRC 24V	SYSTEME DE AQUASTOP WRC 24V
4	* 9543975	AQUASTOP SYSTEM 24V	AQUASTOP SYSTEM 24V	SYSTEME DE AQUASTOP 24V
2	* 9552422	DICHTUNGSSATZ MIT MENGEN- REGELER	SEAL SET WITH FLOW REGULA- TOR	JEU DE GARNITURES D'ETAN- CHEITE AVEC REGULATEUR DE DEBIT
3	* 9622932	MIKROSCHALTER	SWITCH	INTERUPTEUR
4	* 9622935	BODENSCHWIMMERSCHALTER KPL.	GROUND FLOAT SWITCH CPL.	FLOTTEUR AU SOL CPL.
		FÜR NIEDERLANDE	FOR NETHERLANDS	POUR LES PAYS-BAS
5	9627098	RÜCKSCHLAGVENTIL 3/4"	CHECK VALVE 3/4"	CLAPET ANTI-RETOUR 3/4"
6	0408225	DICHTUNG	SEAL	GARNITURE D'ÉTANCHÉITÉ

06.07 NIVEAUREGELUNG

06.07 LEVEL CONTROL

06.07 REGULATION DE NIVEAU



Nvr6_7.doc
01.07.2002/FUS

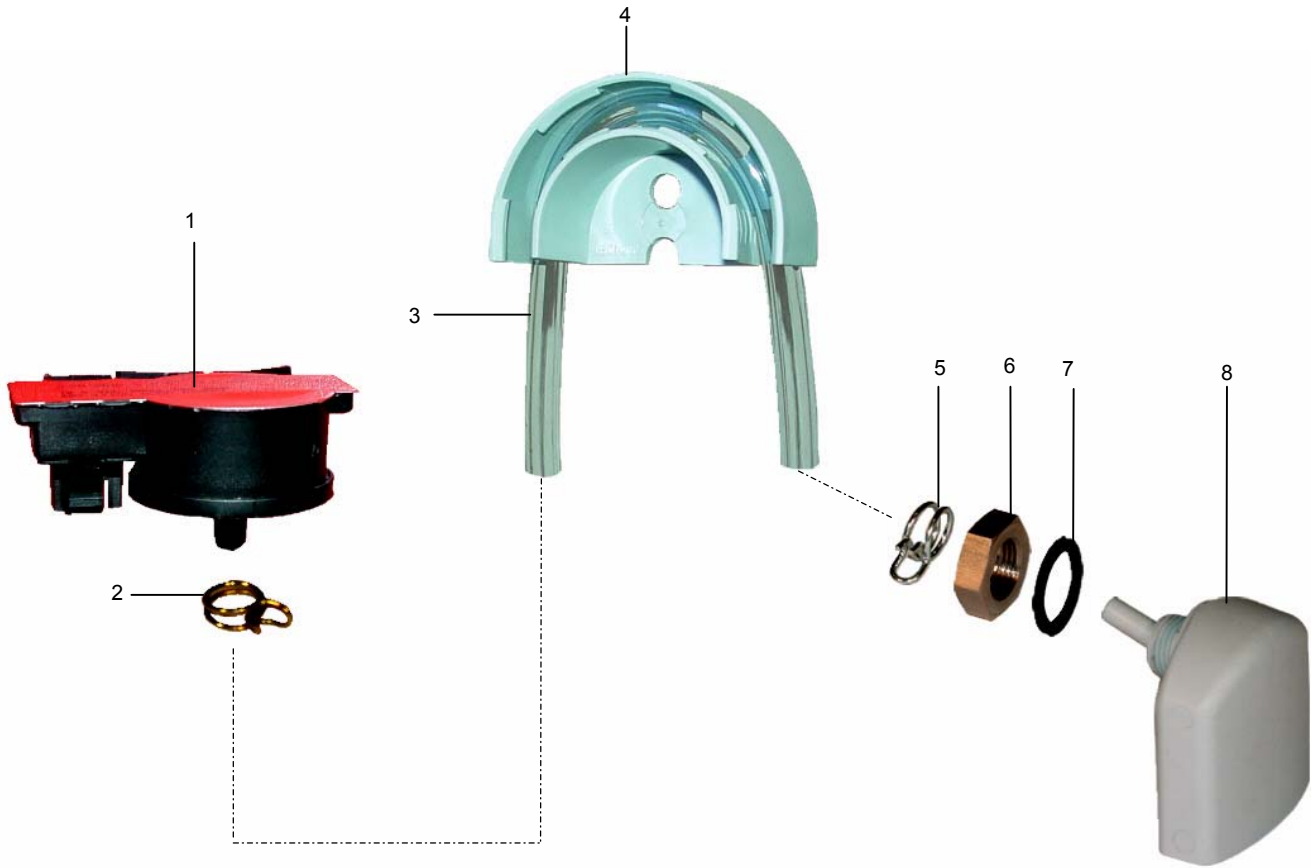

POS	IDENT. NR. IDENT. NO.	BEZEICHNUNG	DESIGNATION	DESIGNATION
1	* 9537961	DRUCKSENSOR	LEVEL SWITCH	INTERRUPTEUR DE NIVEAU
2	* 9500044	SCHLAUCHKLEMME SILBER	HOSE WIRE CLAMP SILVER	COLLIER DE SERRAGE ARGENT
3	* 0260006	SCHLAUCH KLARSICHT Ø5	HOSE TRANSPARENT Ø5	TUYAU TRANSPARENT Ø5
4	9601265	SCHLAUCHHALTER	HOSE BRACKET	SUPPORT DE TUYAU
5	* 9500045	SCHLAUCHKLEMME GELB	HOSE WIRE CLAMP YELLOW	COLLIER DE SERRAGE JAUNE
6	9515957	MUTTER 3/8"	NUT 3/8"	ECROU 3/8"
7	* 9515964	DICHTUNG	PACKING	JOINT
8	* 9515955	LUFTFALLE	AIR TRAP	CHAMBRE DE COMPRESSION

08.36 EINBAUBOILER

08.36 INCORPORATED BOILER

08.36 SURCHAUFFEUR INCORPORE



01.12.2002/FUS

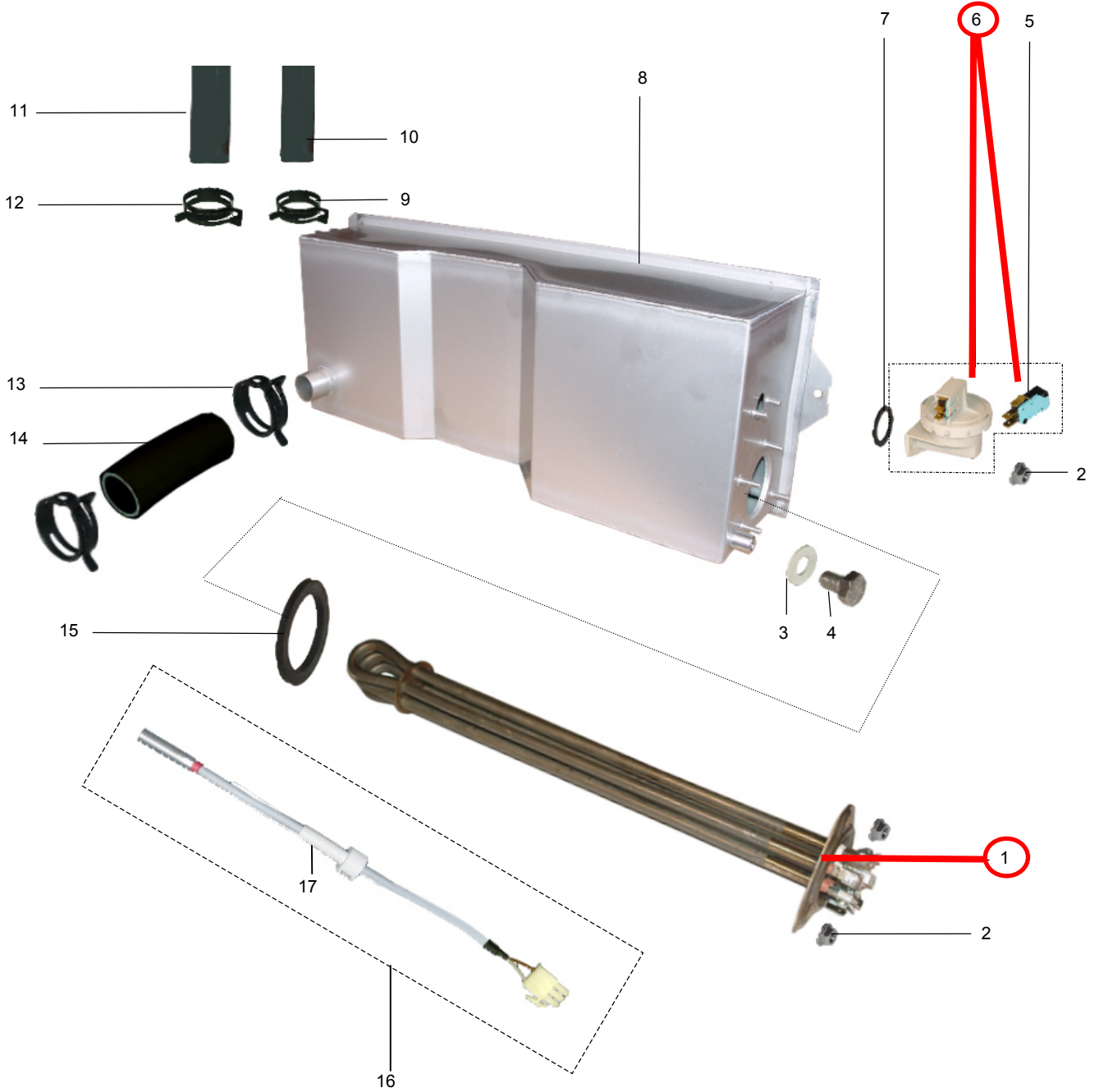

08.36 EINBAUBOILER

08.36 INCORPORATED BOILER

08.36 SURCHAUFFEUR INCORPORE



01.12.2002/FUS

POS	IDENT. NR. IDENT. NO.	BEZEICHNUNG	DESIGNATION	DESIGNATION
①	* 9519586	HEIZKÖRPER 3 KW MIT THERMO-SICHERUNG	HEATING ELEMENT 3 KW WITH THERMAL PROTECTION	RESISTANCE 3 KW AVEC PROTECTION THERMIQUE
	* 9519587	HEIZKÖRPER 4,5 KW MIT THERMOSICHERUNG	HEATING ELEMENT 4,5 KW WITH THERMAL PROTECTION	RESISTANCE 4,5 KW AVEC PROTECTION THERMIQUE
	* 9519588	HEIZKÖRPER 6 KW MIT THERMOSICHERUNG	HEATING ELEMENT 6 KW WITH THERMAL PROTECTION	RESISTANCE 6 KW AVEC PROTECTION THERMIQUE
	* 9519590	HEIZKÖRPER 7,5 KW MIT THERMOSICHERUNG	HEATING ELEMENT 7,5 KW WITH THERMAL PROTECTION	RESISTANCE 7,5 KW AVEC PROTECTION THERMIQUE
2	0335008	MUTTER M5	NUT M5	ECROU M5
3	* 9522687	DICHTUNG	PACKING	JOINT
4	0302006	SCHRAUBE M8X15	SCREW M8X15	VIS M8X15
5	* 0122103	MIKROSCHALTER	SWITCH	INTERRUPTEUR
6	* 9683764	NIVEAUSCHALTER KPL	LEVEL SWITCH CPL	INTERRUPTEUR DE NIVEAU CPL
7	* 0401014	O-RING 18X2	O-RING 18X2	BAGUE 18X2
8	9603367	EINBAUBOILERGEHÄUSE KPL	BOILER HOUSING CPL	BOITE DE SURCHAUFFEUR CPL
9	9609462	FEDERBANDSCHELLE Ø17	HOSE CLAMP TAPE Ø17	RUBAN COLLIER DE SERRAGE Ø17
10	9607596	SCHLAUCH 3/8"	HOSE 3/8"	TUYAU 3/8"
11	9607590	SCHLAUCH 1/2"	HOSE 1/2"	TUYAU 1/2"
12	9607418	FEDERBANDSCHELLE Ø21	HOSE CLAMP TAPE Ø21	RUBAN COLLIER DE SERRAGE Ø21
13	9607416	FEDERBANDSCHELLE Ø36	HOSE CLAMP TAPE Ø36	RUBAN COLLIER DE SERRAGE Ø36
14	9005525	SCHLAUCH 28 X 4 - 55	HOSE 28 X 4 - 55	TUYAU 28 X 4 - 55
	900618	SCHLAUCH 28 X 4 – 100 FÜR ECOSTAR 530F-M FA	HOSE 28 X 4 – 100 FOR ECOSTAR 530F-M FA	TUYAU 28 X 4 – 100 POUR ECOSTAR 530F-M FA
15	* 0101176	HEIZKÖRPERDICHTUNG	HEATING ELEMENT PACKING	JOINT DE RESISTANCE
		GÜLTIG BIS 2005-03	VALID UNTIL 2005-03	VALABLE JUSQU'AU 2005-03
	* 9642324	TEMPERATURFÜHLER MONTAGEBAUGRUPPE	TEMPERATURE PROBE ASSEMBLY	SONDE DE TEMPERATURE JEU DE MONTAGE
	9639301	KABELSCHELLE	CABLE CLIP	COLLIER DE CABLE
		GÜLTIG AB 2005-04	VALID FROM 2005-04	VALABLE A PARTIR DU 2005-04
16	* 9640339	TEMPERATURFÜHLER MONTAGEBAUGRUPPE.	TEMPERATURE PROBE ASSEMBLY	SONDE DE TEMPERATURE JEU DE MONTAGE
17	9639301	KABELSCHELLE	CABLE CLIP	COLLIER DE CABLE

09.17 TANKHEIZUNG

09.17 TANK HEATING

09.17 CHAUFFAGE DE BAC



Th9_17.doc
01.12.2002FUS

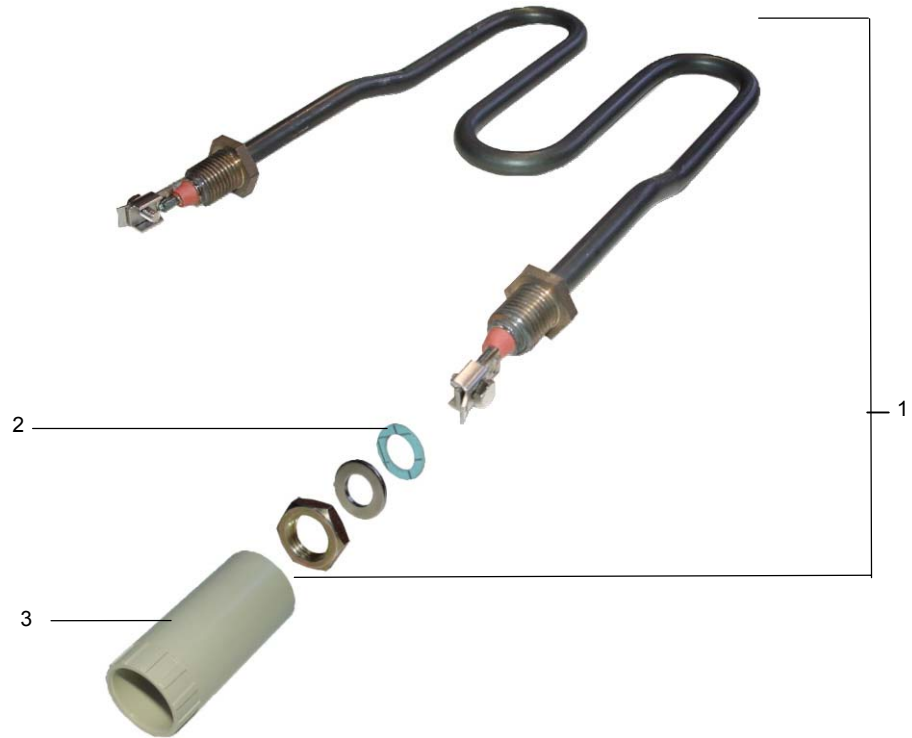

POS	IDENT. NR. IDENT. NO.	BEZEICHUNG	DESIGNATION	DESIGNATION
1	* 9546104	HEIZKÖRPER 1,3 KW	HEATING ELEMENT 1,3 KW	RESISTANCE 1,3 KW
	* 9546105	HEIZKÖRPER 2 KW	HEATING ELEMENT 2 KW	RESISTANCE 2 KW
2	* 0408008	FLACHDICHTUNG 14X25X1,5	FLAT PACKING 14X25X1,5	GARNITURE PLATE 14X25X1,5
3	9548754	BERÜHRUNGSSCHUTZ	PROTECTION AGAINST CONTACT	PROTECTION CONTRE CONTACT

10.16 DOSIERGERÄTE

10.16 DOSING UNITS

CHECK IF PUMPS ARE BLUE

10.16 DOSEURS

GREY PUMP ON THE NEXT PAGE



DOS10_16.doc
01.07.2003/BP

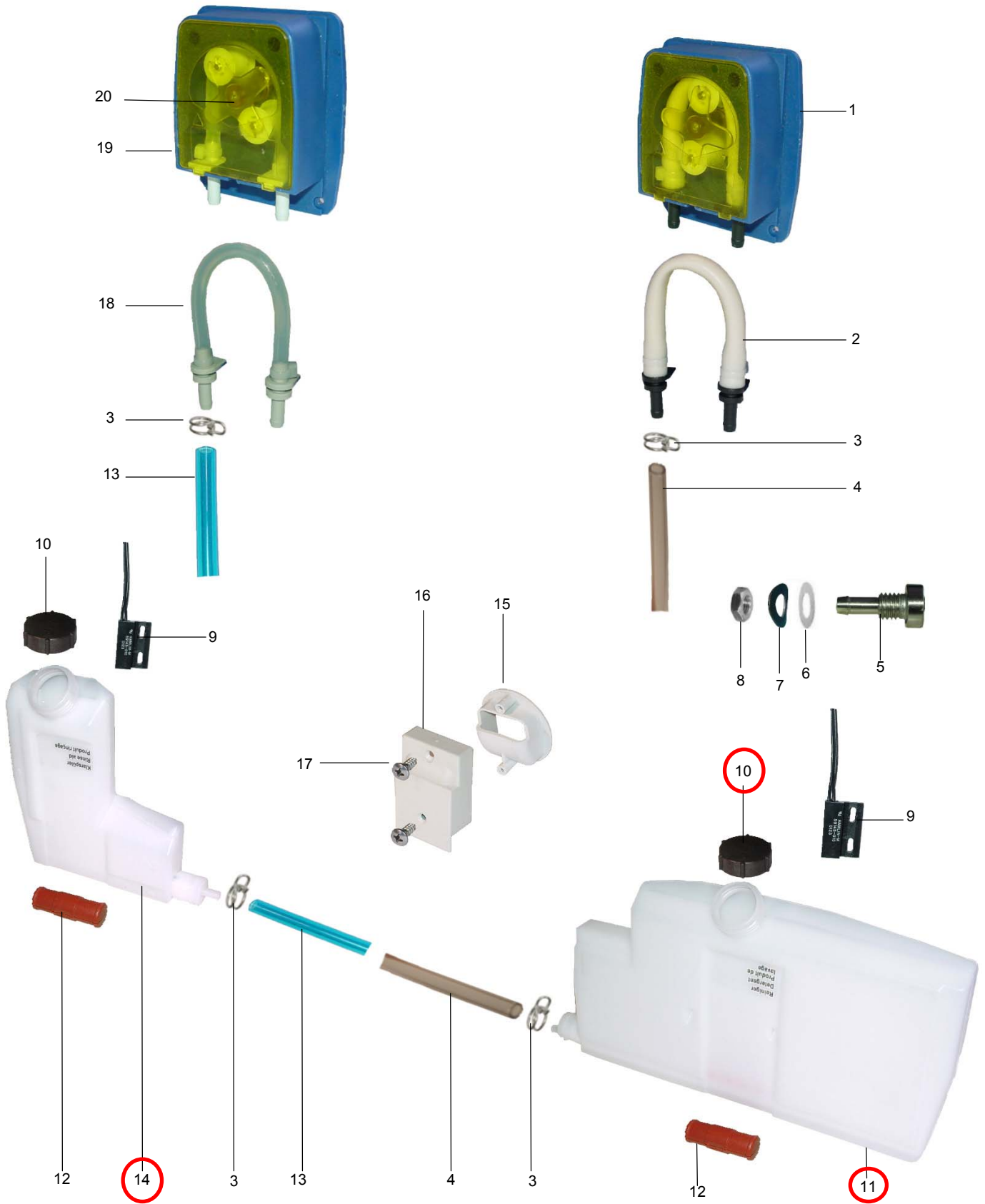

10.16 DOSIERGERÄTE

10.16 DOSING UNITS

10.16 DOSEURS



DOS10_16.doc
01.07.2003/BP

POS	IDENT. NR. IDENT. NO.	BEZEICHNUNG	DESIGNATION	DESIGNATION
1	9544292	REINIGERDOSIERPUMPE KPL	DETERGENT DOSING PUMP CPL.	POMPE DE DOSAGE DETERGENT CPL.
2	V 9511675	SCHLAUCH REINIGER KPL	HOSE DETERGENT CPL.	TUYAU DETERGENT CPL.
3	* 9500045	SCHLAUCHKLEMME GELB	HOSE WIRE CLAMP YELLOW	COLLIER DE SERRAGE JAUNE
4	V 0260007	SCHLAUCH KLARSICHT Ø6	HOSE TRANSPARENT Ø6	TUYAU TRANSPARENT Ø6
5	8000013	SCHLAUCHANSCHLUß	HOSE CONNECTION	CONNEXION DE TUYAU FLEXIBLE
6	* 9603787	FLACHDICHTUNG 10X16X2	FLAT PACKING 10X16X2	GARNITURE PLATE 10X16X2
7	* 9603790	FEDERSCHEIBE M10	SPRING WASHERV M10	RONDELLE ÉLASTIQUE M10
8	0335019	SECHSKANTMUTTER	HEXAGON NUT	ECROU A SIX PANS
9	9606265	MAGNETSCHALTER ÖFFNER	MAGNETIC SWITCH FOR OPENING	INTERRUPTEUR MAGNETIQUE D'OUVERTURE
10	9514096	DECKEL	LID	COUVERCLE
11	9547821	VORRATSBEHÄLTER GROß	STORAGE TANK BIG	RESERVOIR GRAND
12	9549304	SCHWIMMER	FLOAT	FLOTTEUR
13	V 9538712	SCHLAUCH BLAU Ø6	HOSE BLUE Ø6	TUYAU BLEU Ø6
14	9547822	VORRATSBEHÄLTER KLEIN	STORAGE TANK SMALL	RESERVOIR PETIT
15	9514088	GRIFF TEIL 1	HANDLE PART 1	POIGNEE PARTIE 1
16	9514089	GRIFF TEIL 2	HANDLE PART 2	POIGNEE PARTIE 2
17	0330022	SCHRAUBE 4,2X13	SCREW 4,2X13	VIS 4,2X13
18	V 9544088	SCHLAUCH KLARSPÜLER KPL.	HOSE RINSE AID CPL.	TUYAU PRODUIT TENSIO ACTIF CPL.
19	9544293	KLARSPÜLDOSIERPUMPE KPL.	RINSE AID DOSING PUMP CPL.	POMPE DE DOSAGE TENSIO ACTIF CPL.
20	* 9533450	ROTOR	ROTOR	ROTOR

10.19 DOSIERGERÄTE

10.19 DOSING UNITS

10.19 DOSEURS



DOS10_19.doc
10.09.2006/BP

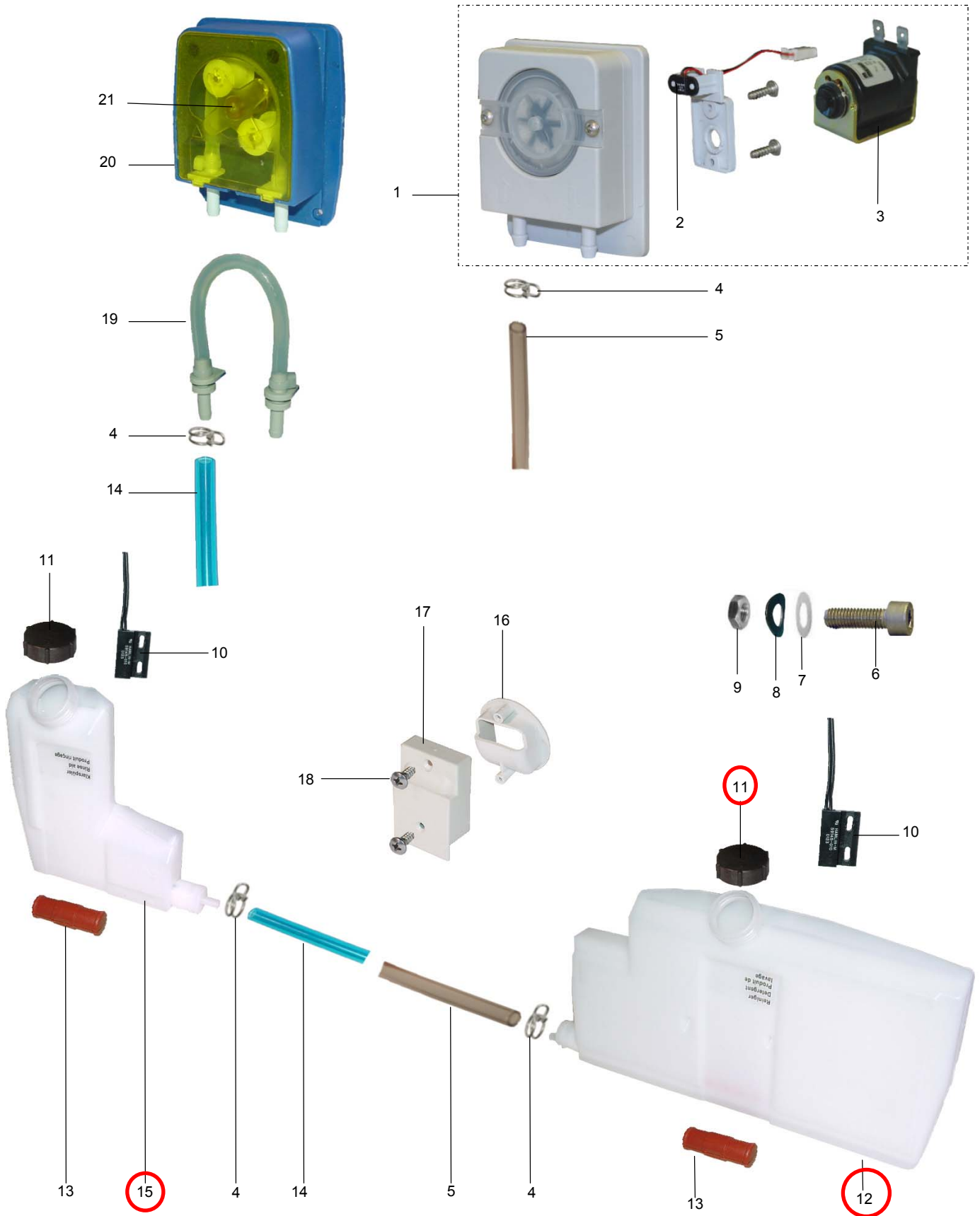

10.19 DOSIERGERÄTE

10.19 DOSING UNITS

10.19 DOSEURS



DOS10_19.doc
10.09.2006/BP

POS	IDENT. NR. IDENT. NO.	BEZEICHNUNG	DESIGNATION	DESIGNATION
1	9609173	REINIGERDOSIERPUMPE ADT KPL.	DETERGENT DOSING PUMP ADT CPL.	POMPE DE DOSAGE DETERGENT ADT CPL.
2	9609907	HALLSENSOR	IMPULSE SENSOR	SENSEUR D'IMPULSION
3	9611095	MAGNETVENTIL	SOLENOID VALVE	ELECTROVANNE
4	* 9500045	SCHLAUCHKLEMME GELB	HOSE WIRE CLAMP YELLOW	COLLIER DE SERRAGE JAUNE
5	V 0260007	SCHLAUCH KLARSICHT Ø6	HOSE TRANSPARENT Ø6	TUYAU TRANSPARENT Ø6
6	9542903	INNENSECHSKANTSCHRAUBE M10X16	HEXAGON SOCKET SCREW M10X16	VIS A SIX PANS CREUX M10X16
7	* 9603787	FLACHDICHTUNG 10X16X2	FLAT PACKING 10X16X2	GARNITURE PLATE 10X16X2
8	* 9603790	FEDERSCHEIBE M10	SPRING WASHERV M10	RONDELLE ÉLASTIQUE M10
9	0335019	SECHSKANTMUTTER	HEXAGON NUT	ECROU A SIX PANS
10	9606265	MAGNETSCHALTER ÖFFNER	MAGNETIC SWITCH FOR OPENING	INTERRUPTEUR MAGNETIQUE D'OUVERTURE
11	9514096	DECKEL	LID	COUVERCLE
12	9547821	VORRATSBEHÄLTER GROß	STORAGE TANK BIG	RESERVOIR GRAND
13	9549304	SCHWIMMER	FLOAT	FLOTTEUR
14	V 9538712	SCHLAUCH BLAU Ø6	HOSE BLUE Ø6	TUYAU BLEU Ø6
15	9547822	VORRATSBEHÄLTER KLEIN	STORAGE TANK SMALL	RESERVOIR PETIT
16	9514088	GRIFF TEIL 1	HANDLE PART 1	POIGNEE PARTIE 1
17	9514089	GRIFF TEIL 2	HANDLE PART 2	POIGNEE PARTIE 2
18	0330022	SCHRAUBE 4,2X13	SCREW 4,2X13	VIS 4,2X13
19	V 9544088	SCHLAUCH KLARSPÜLER KPL.	HOSE RINSE AID CPL.	TUYAU PRODUIT TENSIO ACTIF CPL.
20	9544293	KLARSPÜLDOSIERPUMPE KPL.	RINSE AID DOSING PUMP CPL.	POMPE DE DOSAGE TENSIO AC- TIF CPL.
21	* 9533450	ROTOR	ROTOR	ROTOR

11.40 ELEKTRONIKSTEUERUNG

11.40 ELECTRONIC CONTROL

11.40 COMMAND DE ELECTRONIQUE

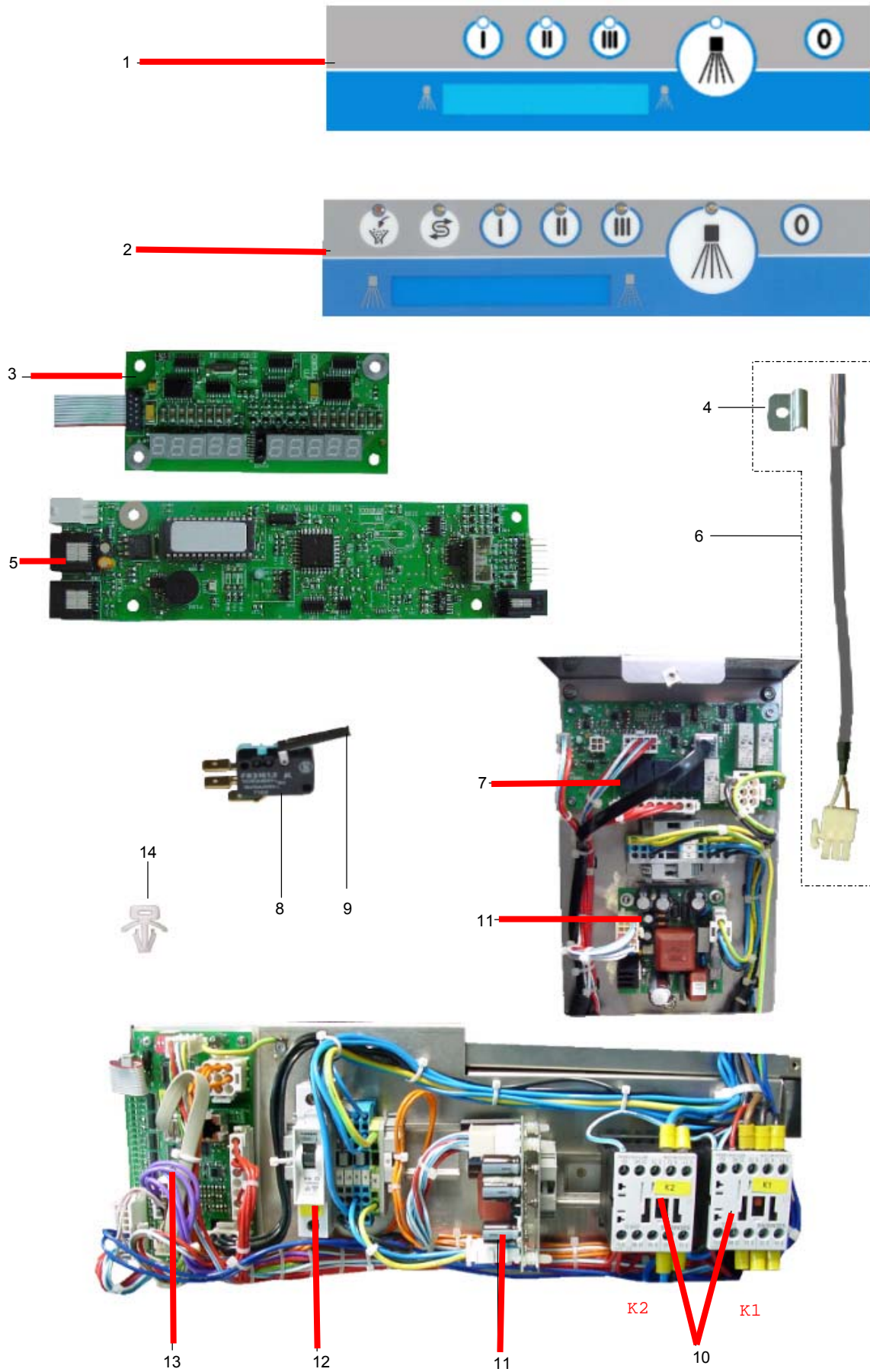

11.40 ELEKTRONIKSTEUERUNG

11.40 ELECTRONIC CONTROL

11.40 COMMAND DE ELECTRONIQUE



POS	IDENT. NR. IDENT. NO.	BEZEICHNUNG	DESIGNATION
1	* 9542137	FOLIENASTATUR FV40.2	SENSOR TOUCH PANEL FV 40.2
2	* 9542136	FOLIENASTATUR FV 40.2 EW	SENSOR TOUCH PANEL FV 40.2 IS
3	* 9542049	MONTAGESATZ ANZEIGENPLATINE	ASSEMBLY KIT SCALE CIRCUIT BOARD
5	* 9541525	MONTAGESATZ CPU	ASSEMBLY KIT CPU
		GÜLTIG BIS 2004-12	VALID UNTIL 2004-12
4	9639363	HALTER	SUPPORT
6	* 9642325	TEMPERATURFÜHLER TANK	TEMPERATURE PROBE TANK
		GÜLTIG AB 2005-01	VALID FROM 2005-01
4	9639363	HALTER	SUPPORT
6	* 9640338	TEMPERATURFÜHLER TANK	TEMPERATURE PROBE TANK
7	* 9617237	E/A2 PLATINE	E/A2 CIRCUIT BOARD
8	* 0122103	MIKROSCHALTER	SWITCH
9	* 0122106	HEBEL FÜR MIKROSCHALTER	LEVER FOR SENSITIVE SWITCH
10	* 9547516	SCHÜTZ	CONTACTOR
11	* 9533502	NETZTEIL	POWER UNIT
	* 0145047	FEINSICHERUNG 2A	FINE WIRE FUSE 2A
12	* 9540605	SICHERUNGSAUTOMAT B10	FUSE BLOCK
13	* 9617235	E/A1 PLATINE	E/A1 CIRCUIT BOARD
	* 9611761	FEINSICHERUNG 16A	FINE WIRE FUSE 16A
	* 9635760	FLACHBANDKABEL 3500 MM	FLAT CABLE 3500 MM
14	9607101	KABELBINDERHALTER	CABLE TIE SUPPORT
		GÜLTIG BIS 2005-02	VALID UNTIL 2005-02
	9540552	EPROM E-EPROM MASCHINENBEZOGEN BESTELLEN (SERIENNUMMER)	EPROM E-EPROM TO BE ORDERED AC- CORDING TO EXECUTION OF MACHINE (SERIAL NUMBER)
		GÜLTIG AB 2005-03	VALID FROM 2005-03
	9604262	EPROM E-EPROM MASCHINENBEZOGEN BESTELLEN (SERIENNUMMER)	EPROM E-EPROM TO BE ORDERED AC- CORDING TO EXECUTION OF MACHINE (SERIAL NUMBER)

13.28 BAUGRUPPEN / EINZELTEILE

13.28 COMPONENT BLOCKS / PARTS

13.28 BLOCS / PIECES DETACHEES



POS	IDENT. NR. IDENT. NO.	BEZEICHNUNG	DESIGNATION	DESIGNATION
1	9516568.03	SEITENVERKLEIDUNG LINKS	SIDE CLADDING, LEFT	REVETEMENT LATERAL GAUCHE
1	9530704.03	SEITENVERKLEIDUNG LINKS FÜR EW	SIDE CLADDING, LEFT FOR IS	REVETEMENT LATERAL GAUCHE POUR AI
2	9546032	ABDECKUNG	COVER	RECOUVREMENT
2	9550081	ABDECKUNG EW	COVER IS	RECOUVREMENT AI
3	9516571	STÜTZBLECH	SUPPORT SHEET	TOLE DE SUPPORT
3	9530701	STÜTZBLECH FÜR EW	SUPPORT SHEET FOR IS	TOLE DE SUPPORT POUR AI
4	9516569	RÜCKWAND	CLADDING, BACK	REVETEMENT ARRIERE
4	9535874	RÜCKWAND FÜR EW	CLADDING, BACK FOR IS	REVETEMENT ARRIERE POUR AI
5	9516568.04	SEITENVERKLEIDUNG RECHTS	SIDE CLADDING, RIGHT	REVETEMENT LATERAL DROIT
5	9530704.04	SEITENVERKLEIDUNG RECHTS FÜR EW	SIDE CLADDING, RIGHT FOR IS	REVETEMENT LATERAL DROIT POUR AI
6	9514190	TÜR KPL.	DOOR CPL.	PORTE CPL
7	9614249	FRONTBLECH	FRONT SHEET	TOLE FRONTALE
	9515464	ABDECKSIEB	COVERING SIEVE	TAMIS DE RECOUVREMENT
	9533300	ABDECKSIEB EW	COVERING SIEVE IS	TAMIS DE RECOUVREMENT AI

16.04 EINBAUWASSERENTHÄRTER

16.04 INCORPORATED SOFTENER

16.04 ADOUCISSEUR INCORPORE



EW16_4.doc
09.04.2002/BP

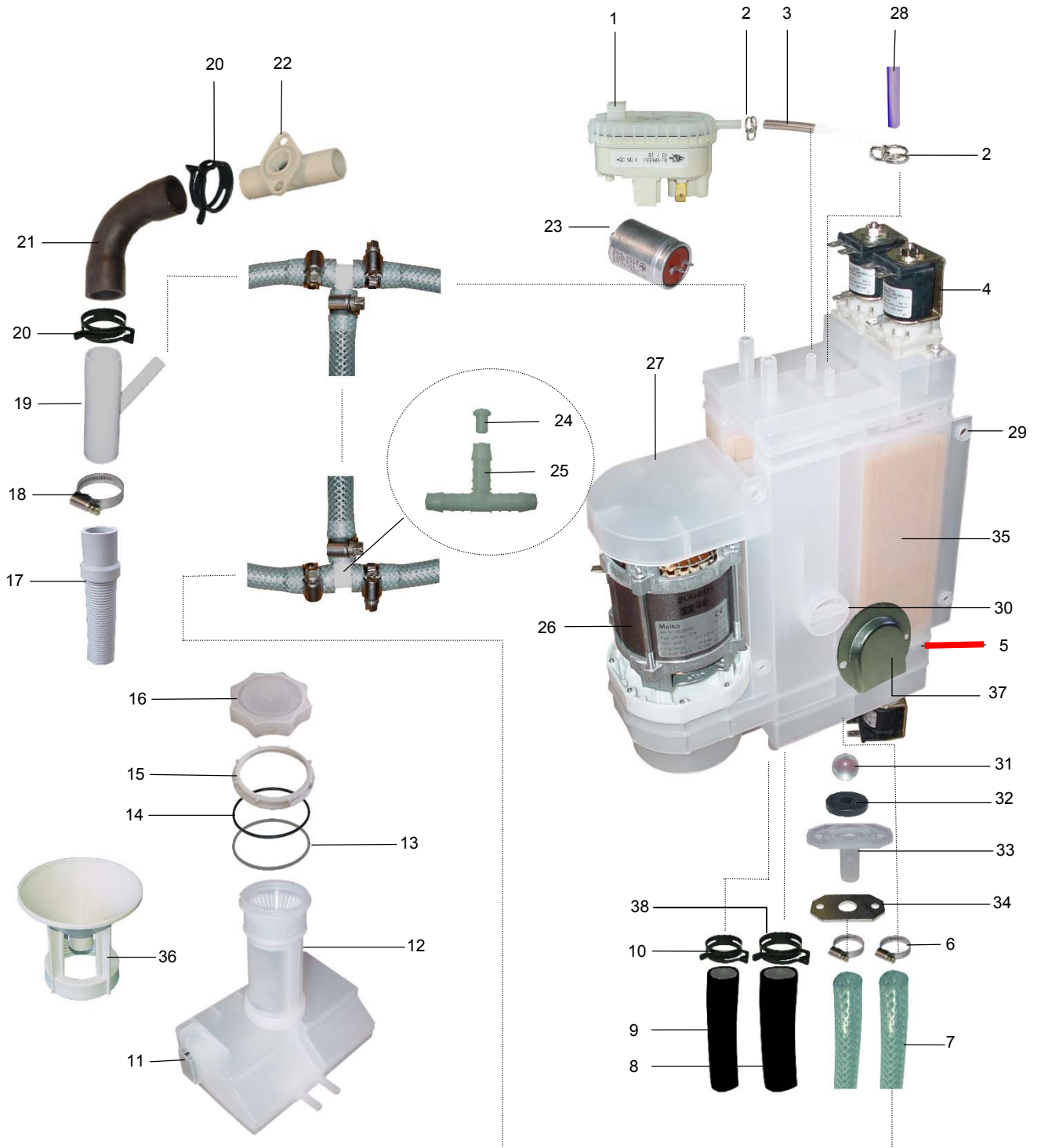

16.04 EINBAUWASSERENTHÄRTER

16.04 INCORPORATED SOFTENER

16.04 ADOUCISSEUR INCORPORE



EW16_4.doc
09.04.2002/BP

POS	IDENT. NR. IDENT. NO.	BEZEICHNUNG	DESIGNATION	DESIGNATION
		GÜLTIG BIS 2005-12	VALID UNTIL 2005-12	VALABLE JUSQU'AU 2005-12
1	* 0130026	NIVEAUSCHALTER	LEVEL SWITCH	INTERRUPTEUR DE NIVEAU
	9533075	HALTEWINKEL FV40.2	FIXING ANGLE FV40.2	ANGLE DE FIXATION FV40.2
	9609625	HALTEWINKEL FV60.2	FIXING ANGLE FV60.2	ANGLE DE FIXATION FV60.2
		GÜLTIG AB 2006-01	VALID FROM 2006-01	VALABLE A PARTIR DU 2006-01
1	* 9622397	NIVEAUSCHALTER	LEVEL SWITCH	INTERRUPTEUR DE NIVEAU
2	* 9500045	SCHLAUCHKLEMME GELB	HOSE WIRE CLAMP YELLOW	COLLIER DE SERRAGE JAUNE
3	V 0260007	SCHLAUCH KLARSICHT Ø6	HOSE TRANSPARENT Ø6	TUYAU TRANSPARENT Ø6
4	* 9545436	MAGNETVENTIL 24V	SOLENOID VALVE 24V	ELECTROVANNE 24V
5	9547536	WASSERENTHÄRTUNGSGERÄT OHNE POS.27	INCORPORATED SOFTENER WITHOUT POS.27	ADOUCCISSEUR INCORPORE SANS POS.27
6	0233036	SCHLAUCHKLEMME 10/16	HOSE WIRE CLAMP 10/16	COLLIER DE SERRAGE 10/16
7	9534470	SCHLAUCH DN 9X3 16BAR	HOSE DN 9X3 16BAR	TUYAU DN 9X3 16BAR
8		SIEHE BLATT 08 EINBAUBOILER	SEE PAGE 08	VOIR PAGE 08
9		SIEHE BLATT 08 EINBAUBOILER	SEE PAGE 08	VOIR PAGE 08
10	9609462	FEDERBANDSCHELLE Ø17	HOSE CLAMP TAPE Ø17	RUBAN COLLIER DE SERRAGE Ø17
11	9519952	REEDSCHALTER	SWITCH	INTERRUPTEUR
12	9528948	SALZLÖSEBEHÄLTER	SALT DISSOLVING CONTAINER	RESERVOIR DISSOLUTIONDU SEL
13	9534626	STÜTZRING	SUPPORT RING	BAGUE DE SUPPORT
14	9533155	O-RING 66X3	O-RING 66X3	BAGUE 66X3
15	9528958	MUTTER	NUT	ECROU
16	9532583	DECKEL KPL.	LID CPL.	COUVERCLE CPL.
17	* 9609672	SCHLAUCH 3/4"X2500	HOSE 3/4"X2500	TUYAU 3/4"X2500
18	0233045	SCHLAUCHKLEMME 20/32	HOSE WIRE CLAMP 20/32	COLLIER DE SERRAGE 20/32
19	9533227	SCHLAUCHVERBINDUNG Y-FORM	Y HOSE CONNECTION	Y CONNEXION DE TUYAU
20	9607417	FEDERBANDSCHELLE Ø30	HOSE CLAMP TAPE Ø30	RUBAN COLLIER DE SERRAGE Ø30
21	9514680	SCHLAUCH	HOSE	TUYAU
22	9515230	BELÜFTUNGSVENTIL	VENT VALVE	VALVE D'AERATION
23	* 9520030	KONDENSATOR	CONDENSER	CONDENSEUR
24	9534818	DROSSEL	THROTTLE	ETRANGLEMENT
25	9534819	SCHLAUCHVERBINDUNG T-FORM	T HOSE CONNECTION	T CONNEXION DE TUYAU
26	* 9607881	DRUCKSTEIGERUNGSPUMPE 220-240V 50HZ	BOOSTER PUMP 220-240V 50HZ	SURPRESSEUR 220-240V 50HZ
	V 9523844	GLEITRINGDICHTUNG	AXIAL FACE SEAL	GARNITURE ETANCHE A ANNEAU GLISSANT
27	9532612	ABDECKUNG	COVER	RECOUVREMENT
28	V 9538712	SCHLAUCH BLAU Ø6	HOSE BLUE Ø6	TUYAU BLEU Ø6
29	* 9511585	O-RING 12X3 (NICHT ABGEBILDET)	O-RING 12X3 (NOT DISPLAYED)	BAGUE 12X3 (PAS D'IMAGE)
30	* 0650076	DICHTUNG (NICHT ABGEBILDET)	SEAL (NOT DISPLAYED)	GARNITURE D'ÉTANCHÉITÉ
31	9529661	KUGEL FÜR RÜCKSCHLAGVENTIL	BALL FOR CHECK VALVE	ROBINET POUR CLAPET ANTI- RETOUR

16.04 EINBAUWASSERENTHÄRTER

16.04 INCORPORATED SOFTENER

16.04 ADOUCISSEUR INCORPORE



EW16_4.doc
09.04.2002/BP

POS	IDENT. NR. IDENT. NO.	BEZEICHNUNG	DESIGNATION	DESIGNATION
32	* 9527332	DICHTUNG FÜR RÜCKSCHLAG- VENTIL	PACKING FOR CHECK VALVE	JOINT POUR CLAPET ANTI- RETOUR
33	9527331	ANSCHLUßSTUTZEN FÜR RÜCK- SCHLAGVENTIL	CONNECTION PIECE FOR FOR CHECK VALVE	PIECE DE CONNEXION POUR CLAPET ANTI-RETOUR
34	9553043	FLANSCHPLATTE	FLANGE PLATE	PLAQUE DE BRIDE
35	9603362	BEHÄLTER OHNE PUMPE/VENTILE/DECKEL	STORAGE TANK WITHOUT PUMP/VALVE/COVER	RESERVOIR SANS POMPE/VIDANGE/ RECOU- VERMENT
36	9538007	FÜLLSTUTZEN	FILLING SOCKET	TREMIE DE REMPLISSAGE
37	8000609	WASSERLEITBLECH	WATER GUIDING SHEET	TOLE DE DEVIATION D'EAU
38	9607418	FEDERBANDSCHELLE Ø21	HOSE CLAMP TAPE Ø21	RUBAN COLLIER DE SERRAGE Ø21

18.11 LAUGENPUMPE

18.11 DRAIN PUMP

18.11 POMPE DE VIDANGE

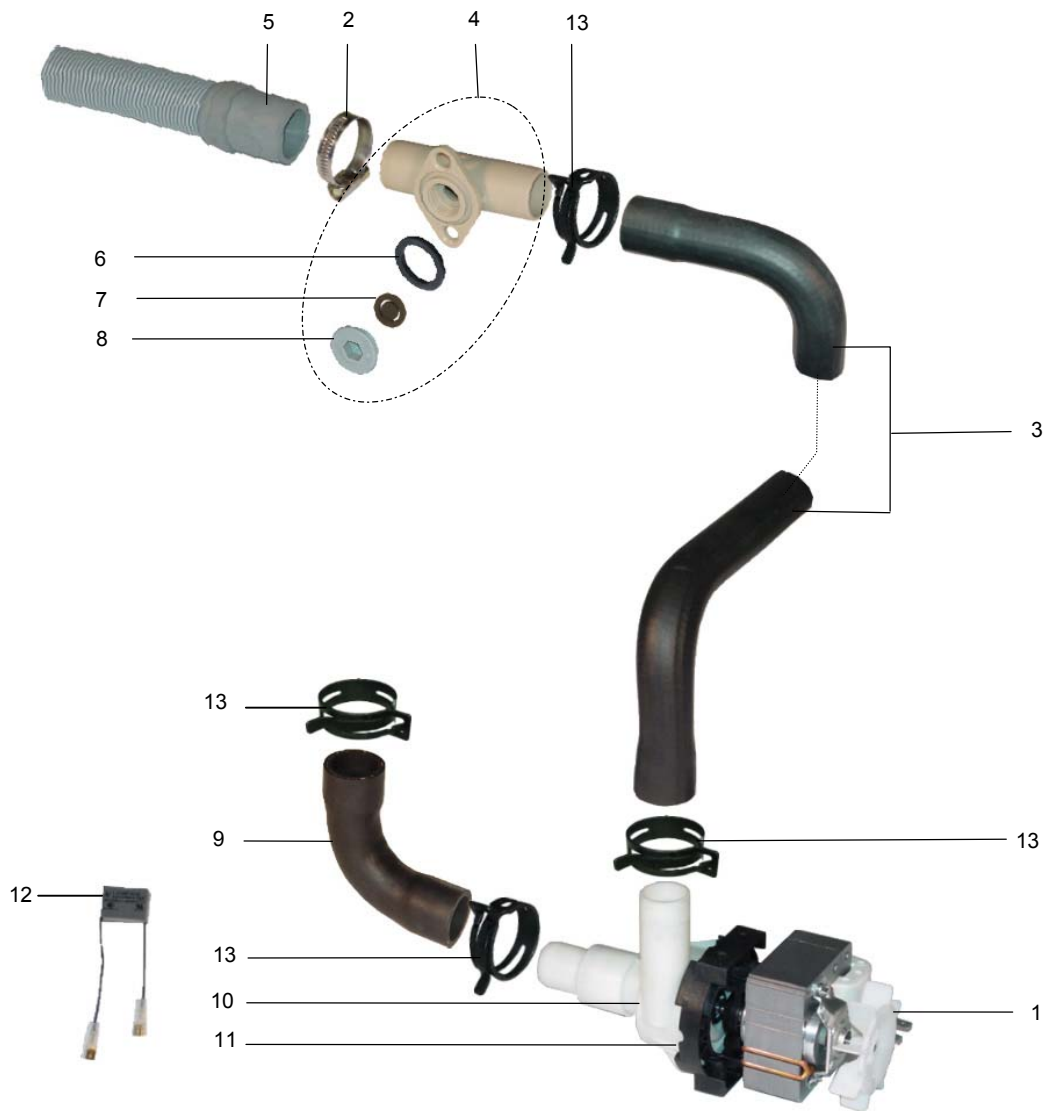

POS	IDENT. NR. IDENT. NO.	BEZEICHUNG	DESIGNATION	DESIGNATION
1	* 9544233	LAUGENPUMPE KPL.	DRAIN PUMP CPL.	POMPE DE VIDANGE CPL.
2	0233045	SCHLAUCHKLEMME 20/32	HOSE WIRE CLAMP 20/32	COLLIER DE SERRAGE 20/32
3	9517067	SCHLAUCH	HOSE	TUYAU
4	9515229	BELÜFTUNGSVENTIL KPL.	VENT VALVE CPL.	VALVE D'AERATION CPL.
5	* 9609672	SCHLAUCH	HOSE	TUYAU
6	0401016	O-RING 21X2	O-RING 21X2	BAGUE 21X2
7	9515234	DICHTUNG	PACKING	JOINT
8	9515231	SCHRAUBE	SCREW	VIS
9	9514680	SCHLAUCH	HOSE	TUYAU
10	9523849	PUMPENGEHÄUSE	PUMP HOUSING	CORPS DE POMPE
11	* 9523850	O-RING	O-RING	BAGUE
12	9550030	R-C BAUTEIL	R-C UNIT	ELEMENT RC
13	9607417	FEDERBANDSCHELLE Ø30	HOSE CLAMP TAPE Ø30	RUBAN COLLIER DE SERRAGE Ø30

22.14 DRUCKSTEIGERUNGSPUMPE

22.14 BOOSTER PUMP

22.14 SURPRESSEUR

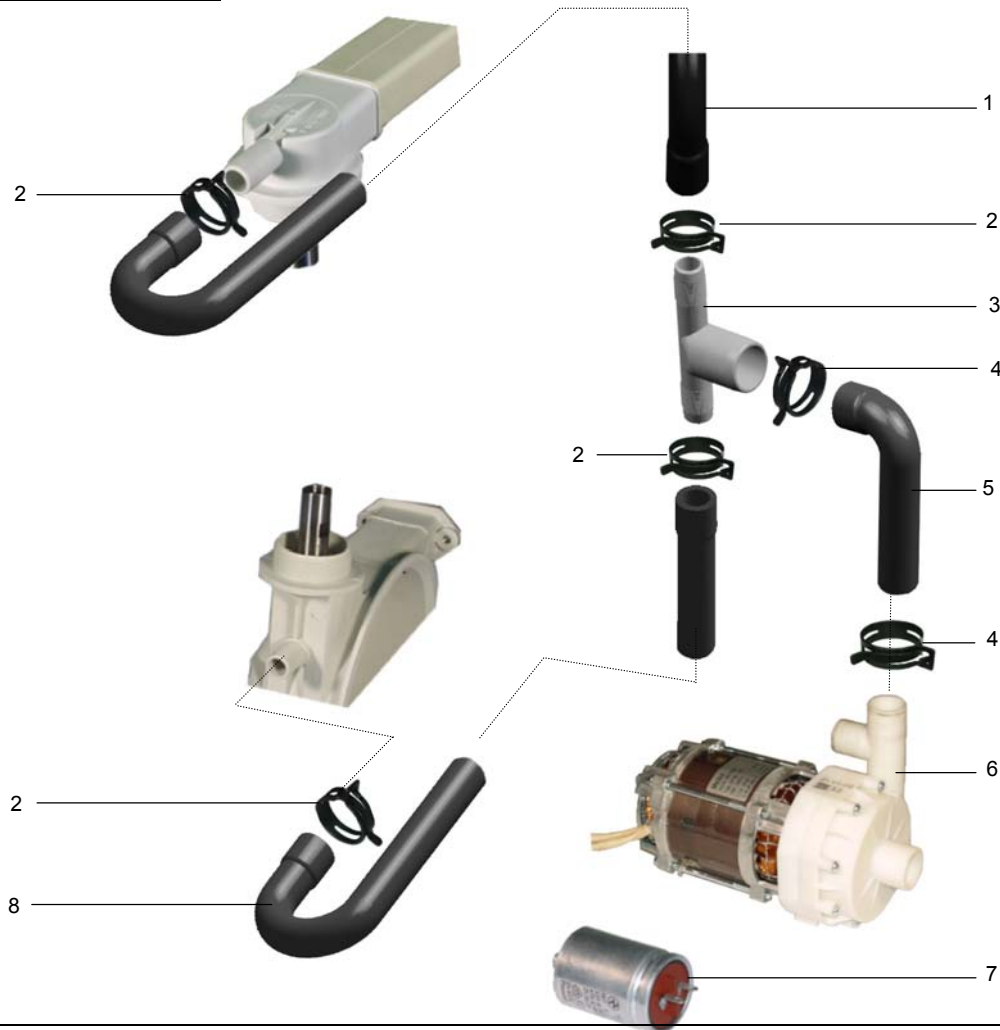

POS	IDENT. NR. IDENT. NO.	BEZEICHUNG	DESIGNATION	DESIGNATION
1	9601256	SCHLAUCH	HOSE	TUYAU
2	9607418	FEDERBANDSCHELLE Ø21	HOSE CLAMP TAPE Ø21	RUBAN COLLIER DE SERRAGE Ø21
3	9601255	SCHLAUCHVERTEILER	DISTRIBUTION PIPE	DISTRIBUTION DE TUYAU
4	9607417	FEDERBANDSCHELLE Ø30	HOSE CLAMP TAPE Ø30	RUBAN COLLIER DE SERRAGE Ø30
5	9601259	SCHLAUCH	HOSE	TUYAU
6	* 9638029	DRUCKSTEIGERUNGSPUMPE KPL.	BOOSTER PUMP CPL.	SURPRESSEUR CPL.
		200-240V 0,2 KW 50 HZ	200-240V 0,2 KW 50 HZ	200-240V 0,2 KW 50 HZ
*				
*	9523267	PUMPENLAUFRAD 50 HZ	PUMP WHEEL 50 HZ	ROUE DE POMPE 50 HZ
*				
V	9523844	GLEITRINGDICHTUNG KPL.	SLIDING SEAL CPL.	JOINT AXIAL CPL.
*	9523260	O-RING	O-RING	BAGUE
7	* 9520030	KONDENSATOR	CONDENSER	CONDENSEUR
8	9601257	SCHLAUCH	HOSE	TUYAU

24.07 FREIER AUSLAUF

24.07 AIR GAP

24.07 ECOULEMENT LIBRE

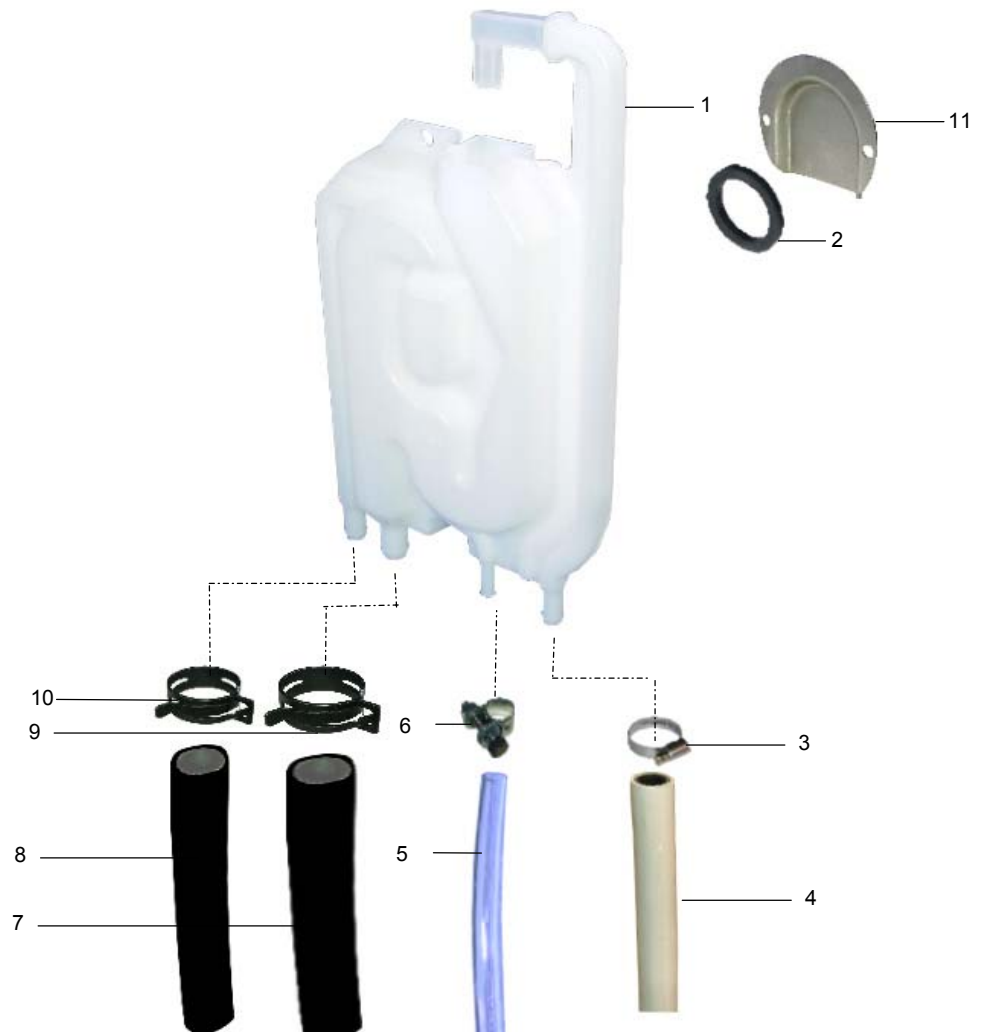

POS	IDENT. NR. IDENT. NO.	BEZEICHNUNG	DESIGNATION	DESIGNATION
1	* 9523195	FREIER AUSLAUF KPL.	AIR GAP CPL.	ECOULEMENT LIBRE CPL.
2	* 0650076	DICHTUNG	PACKING	JOINT
3	0233036	SCHLAUCHKLEMME 10/16	HOSE WIRE CLAMP 10/16	COLLIER DE SERRAGE 10/16
4		SIEHE BLATT 04 MAGNETVENTIL	SEE PAGE 04 SOLENOID VALVE	VOIR PAGE 04 ELECTRO VANNE
5		SIEHE BLATT 10 DOSIERGERÄTE	SEE PAGE 10 DOSING UNITS	VOIR PAGE 10 DOSEURS
6	9605930	SCHLAUCHKLEMME 8,5-9,5	HOSE WIRE CLAMP 8,5-9,5	COLLIER DE SERRAGE 8,5-9,5
7		SIEHE BLATT 08 EINBAUBOILER	SEE PAGE 08 INCORPORATED BOILER	VOIR PAGE 08 SURCHAUFFEUR INCORPORE
8		SIEHE BLATT 08 EINBAUBOILER	SEE PAGE 08 INCORPORATED BOILER	VOIR PAGE 08 SURCHAUFFEUR INCORPORE
9	9607418	FEDERBANDSCHELLE Ø21	HOSE CLAMP TAPE Ø21	RUBAN COLLIER DE SERRAGE Ø21
10	9609462	FEDERBANDSCHELLE Ø17	HOSE CLAMP TAPE Ø17	RUBAN COLLIER DE SERRAGE Ø17
11	8000609	WASSERLEITBLECH	WATER GUIDING SHEET	TOLE DE DEVIATION D'EAU

25.01 TÜRGEWICHTSAUSGLEICH

25.01 DOOR COUNTERWEIGHT

25.01 EQUILLIBRAGE DE POIDS DE PORTE



TA25_1.doc
01.07.2000/FH

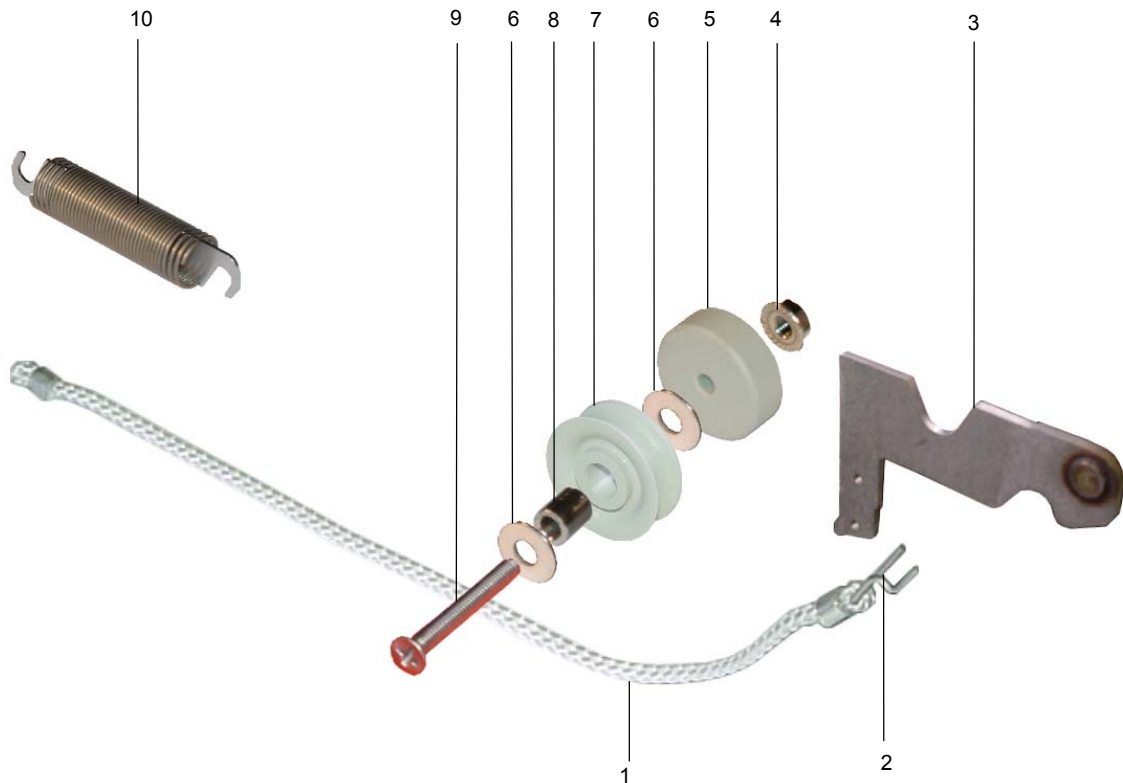

POS	IDENT. NR. IDENT. NO.	BEZEICHNUNG	DESIGNATION	DESIGNATION
1	V 0435151	SEIL	ROPE	CORDE
2	* 0435150	SEILHAKEN	ROPE HOOK	CROCHET
3	9516557.04	TÜRSCHARNIER LINKS KPL.	DOORHINGE LEFT CPL.	PORTE A CHARNIERE GAUCHE CPL.
3	9516557.03	TÜRSCHARNIER RECHTS KPL.	DOORHINGE RIGHT CPL.	PORTE A CHARNIERE DROIT CPL.
4	0335008	MUTTER M5	NUT M5	ECROU M5
5	9520727	ABSTANDSROLLE	DISTANCE ROLL	ROULEAU DE DISTANCE
6	0340020	SCHEIBE	DISK	DISQUE
7	* 9600964	SEILROLLE	ROPE ROLLER	ROULEAU POUR CORDE
8	9520736	LAGERRING	BEARING RING	BAGUE DE PALIER
9	0306122	SCHRAUBE M5X30	SCREW M5X30	VIS M5X30
10	V 9521764	ZUGFEDER KPL.	TENSION SPRING CPL.	RESSORT DE TENSION CPL.