

NP70-10

PENTOLE A GAS ED ELETTRICHE 50 LITRI
 GAS AND ELECTRIC HEATED BOILING PANS 50 LITERS
 MARMITES A GAZ ET ELECTRIQUES 50 LITRES
 GAS UND ELEKTROBEHEIZT KOCHKESSEL 50 LITERS

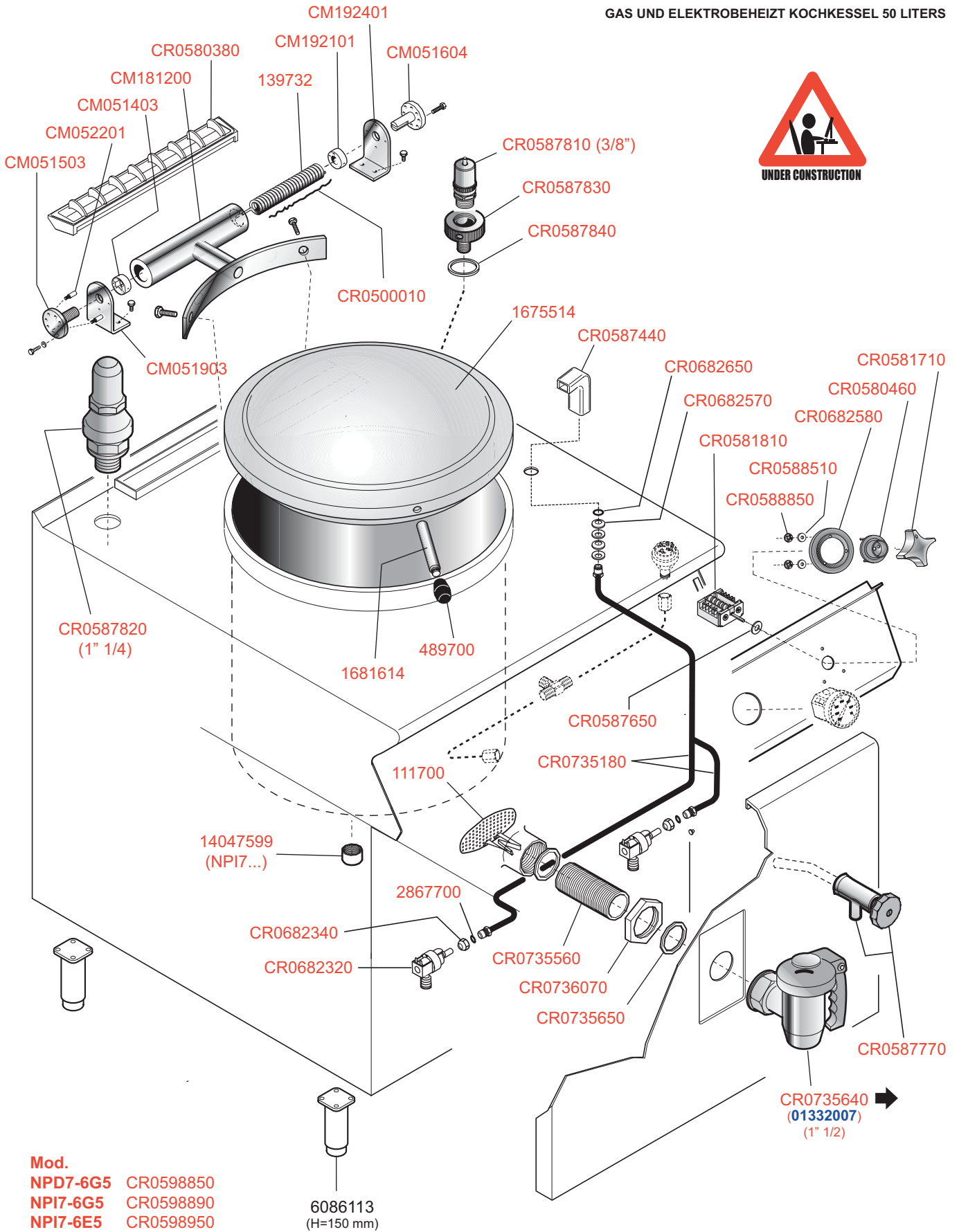

Mod.
 NPD7-6G5 CR0598850
 NPI7-6G5 CR0598890
 NPI7-6E5 CR0598950

 MARENO INDUSTRIE ALI spa Mareno di Piave (TV)	ELABORATO:	APPROVATO:	GRUPPO:	DENOMINAZIONE:		
			Serie NP70	Impianto idraulico e mobile - Particolari comuni		
	DATA:	DATA:	PARTICOLARE:	REV. N.	DEL	DISEGNO N.
	21 Mar 2010	21 Mar 2010	Disegno esploso per ricambi	Z00	0310	3.P70.20/1
SOST. DIS.						

1" 1/2 CON - 50 Lit.
Cod. CR0735640 (01332007)
 (Serie N-Protagonista 70 e 90 - 2008)

- 1 Corpo cod. 22901077
- 2 Cilindro cod. 22100959
- 3 Calotta cod. 22900804
- 4 Vite fissaggio cilindro cod. 51007375
- 5 Vite di fermo rotazione cod. 31007370
- 6 Impugnatura atermica cod. 34003011
- 7 Perno fissaggio impugnatura cod. 31004854
- 8 Anello tipo RA cod. 51000209
- 9 Dado cod. 22801231
- 10 Guarnizione cod. 34012778

A

Serial No.
 < MA020.....

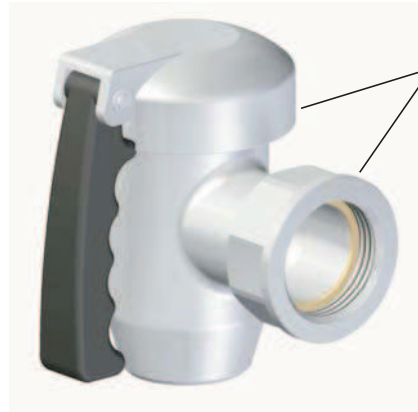

CR0735640
 (01332007)
 (1" 1/2)

17000898
 (Loctite 55)



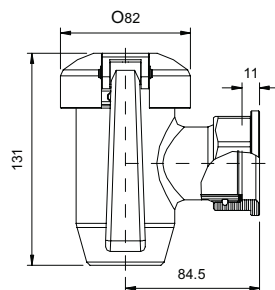

Cod. 77122400
 Grasso/Grease
 art. 36206760
 KLUBER Non Trop
 PLB DR
 (Cod. art. 572411)
 tubo da 100 g)

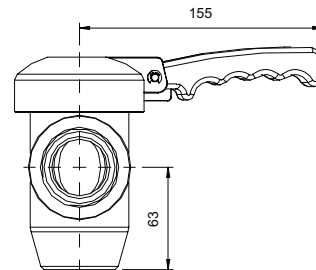

Dimens.
 mm



 MARENO INDUSTRIE ALI spa Mareno di Piave (TV)	ELABORATO:	APPROVATO:	GRUPPO:	DENOMINAZIONE:		
			Serie NP70 - 90	Rubinetto di scarico da 1" 1/2		
	DATA:	DATA:	PARTICOLARE:	REV. N.	DEL	DISEGNO N.
	16 Nov 2010	16 Nov 2010	Disegno esploso per ricambi 	Z00	1110	3.P70.20/2
	SOST. DIS.					

NP70-10

CR0580380

PENTOLE DA LITRI 50 - RISCALDAMENTO DIRETTO A GAS
 GAS DIRECT HEATED BOILING PANS
 MARMITES A GAZ CHAUFFE DIRECTE
 DIREKTBEHEIZT GAS KOCHKESSEL



Mod.

NPD76G5 CR0598850

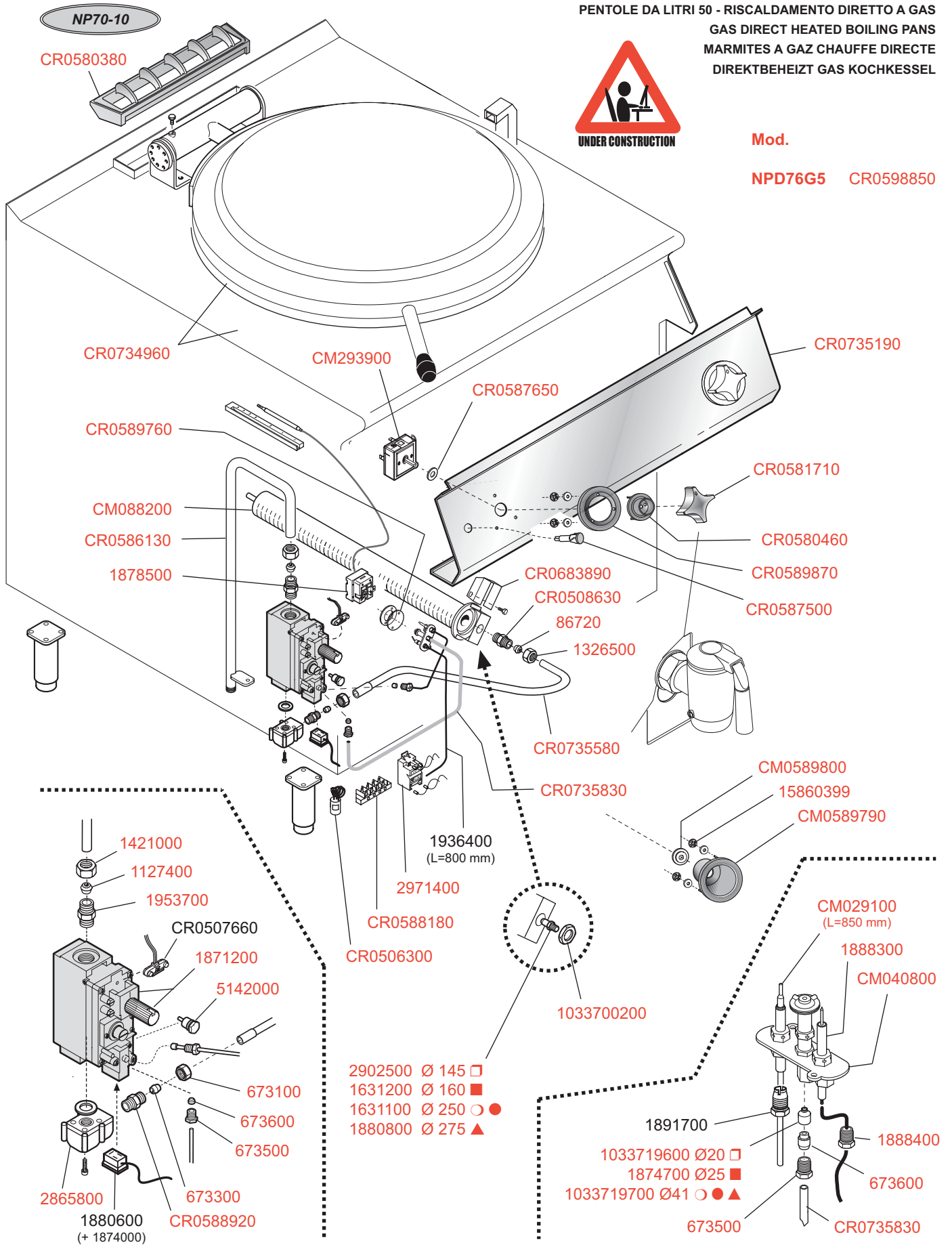

— ID GAS: \square G30/50 \blacksquare G30/29 \circ G20/20 \bullet G25/25 \blacktriangle G25/20 \oplus G120/8 \oplus G110/8 —

 MARENO INDUSTRIE ALI spa Mareno di Piave (TV)	ELABORATO:	APPROVATO:	GRUPPO:	DENOMINAZIONE:		
			Serie NP70	Impianto gas		
	DATA:	DATA:	PARTICOLARE:	REV. N.	DEL	DISEGNO N.
	23 Mar 2010	23 Mar 2010	Disegno esploso per ricambi	Z00	0310	3.P70.23
SOST. DIS.						