

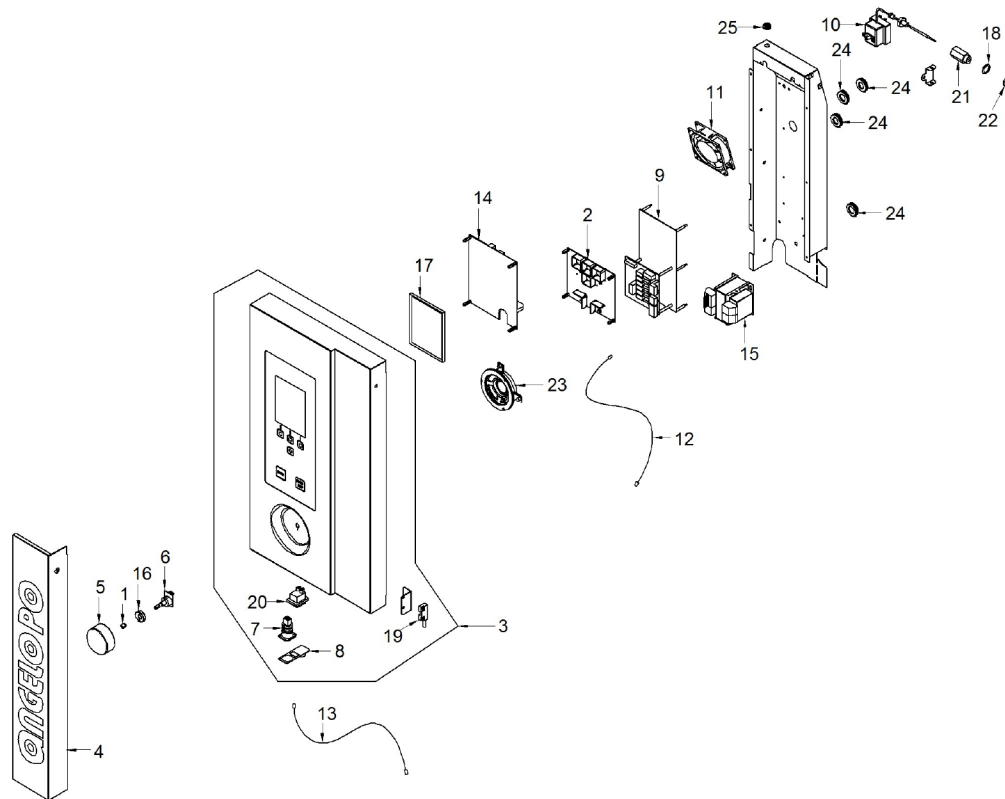











We use cookies to track usage and preferences. / Questo sito utilizza i cookies per finalità di profilazione e navigazione. [Accept / Accetta](#)

Supporting your success

1
HOME -> OVENS -> FX -> FX61E3 -> K001890-CONTROL BOX -> 1

	Modification		Code		Opt.	Description		Rec. Price		Validity date
			1			3170290		X	0,66	1 15/12/2009-
			2			6300691		X	144,00	1 15/12/2009-
			3			6300689			956,63	1 15/12/2009-30/01/2013
			4			6300717			145,20	1 15/12/2009-
			5			3104141		X	20,38	1 15/12/2009-23/10/2012

We use cookies to track usage and preferences. / Questo sito utilizza i cookies per finalità di profilazione e navigazione. [Accept / Accetta](#)

		7	3108800	USB CONNECTOR	X	22,84	1 15/12/2009-
		8	3108810	USB COVER		3,80	1 15/12/2009-16/10/2011
		9	6300756	RELAYS PCB ASS.Y	X	726,41	1 15/12/2009-
		10	3111950	SAFETY THERMOSTAT	X	132,00	1 15/12/2009-21/01/2013
		11	3113740	DRIVEN FAN 220/240V 50/60Hz		0,00	1 15/12/2009-29/02/2012
		12	3116170	CABLE RJ45 L=1MT	X	6,29	1 15/12/2009-
		13	3116190	USB A-B CABLE		6,44	1 15/12/2009-
		14	6300757	RELAYS CPU ASS.Y	X	1442,59	1 15/12/2009-31/05/2015
		15	3117170	TRANSFORMER	X	59,01	1 15/12/2009-
		16	3121920	SPACER		0,00	1 15/12/2009-10/01/2013
		17	3122360	LCD PCB	X	513,00	1 15/12/2009-
		18	3151441	WASHER Ø22Ø16.2=1.5 CU		1,20	1 15/12/2009-
		19	32V5740	MAGNETIC MICROSWITCH	X	15,14	1 15/12/2009-
		20	32W0631	SWITCH	X	10,73	1 15/12/2009-14/04/2013
		21	33Q5630	CONNECT MF 3/8"-M16		9,77	1 15/12/2009-21/01/2013
		22	36Q1171	LOCKNUT M16X1.5		3,80	1 15/12/2009-
		23	6025420	SPEAKER CASH	X	19,87	1 15/12/2009-
		24	32X0140	GROMMET Ø13,5-Ø25		2,50	4 15/12/2009-
		25	32X0200	GROMMET Ø7.5-Ø11.5		1,20	1 15/12/2009-
		27	000000	-		0,00	1 15/12/2009-31/08/2012