

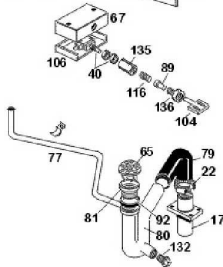

**FC101E**

**Edition 20141007-**

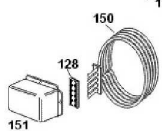
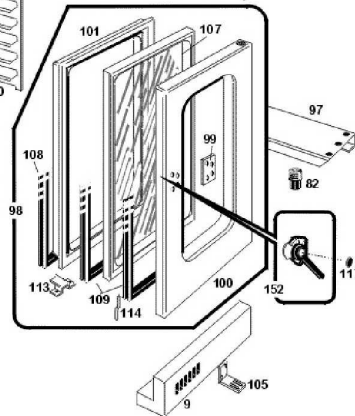
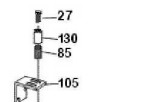
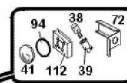
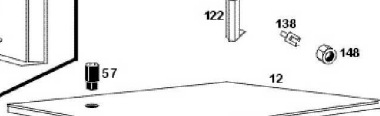
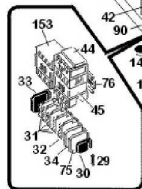
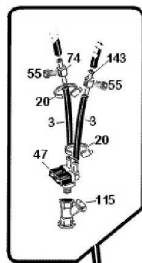
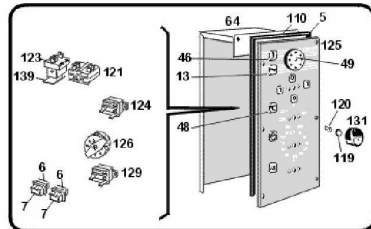
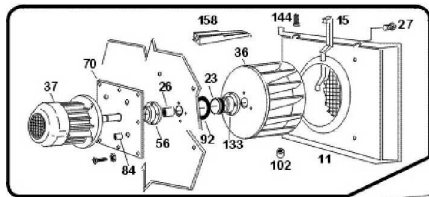

Pos	Code	Description	Info
001	111AA05	RUBBER HOSE Ø30 Ø20	01/03/1996-
002	131AA23	RUBBER HOSE Ø35 Ø28	01/03/1996-
003	131AA12	RUBBER HOSE Ø17 Ø10 X H <sup>2</sup> O	01/03/1996-
004	3188650	WASHER	23/11/2010-
005	137AA15	GASKET	01/03/1996-
006	170WR01	JUNCTION BOX	01/03/1996-
007	171WR01	JUNCTION BOX	01/03/1996-
008	35C3691	LH PANEL ASS.Y	22/01/1998-
009	30W3281	TRAY ASS.Y	17/03/1999-
010	30D5820	COOKING CHAMBER	01/06/1998-
011	35Y0580	CHAMBER AIR GUIDE	01/06/1998-
012	30G2910	OVEN COVER ASS. Y	01/03/1996-
013	32W0101	GREEN LIGHT	01/03/1996-
014	30Z2050	PIPE AISI304 Ø12- 159X77	01/06/1998-
015	30Z2060	END PIPE, COMPLETE	01/06/1998-
016	30Z7691	STEAM DRAIN PIPE ASS.Y	01/03/1996-
017	33Q6100	LOWER DRAIN PIPE	01/03/1996-
018	36G6750	RING NUT	01/03/1996-
019	3140300	HOSE CLAMP	10/01/1997-
020	3140230	12/20 PIPE CLAMP	01/03/1996-
021	3140300	HOSE CLAMP	01/03/1996-
022	3140380	HOSE CLAMP	01/03/1996-
023	3150900	GASKET	01/03/1996-
024	3151441	WASHER Ø22 Ø16.2=1.5 CU	14/10/1998-
025	3151450	WASHER	01/03/1996-
026	3151490	BEARING	01/03/1996-
027	3190020	SCREW M6X10	01/03/1996-
028	3170110	ACCOMODATION Ø6	01/03/1996-
029	3201540	FUSE 5X20	01/03/1996-
030	32D0870	TERMINAL CLAMP	01/03/1996-
031	32D0950	LIVE TERMINAL	01/03/1996-
032	32D0970	GROUND TERMINAL	01/03/1996-
033	32D0960	TERMINAL END COVER	01/03/1996-
034	32D1730	FUSE TERMINAL BOARD	24/01/2002-
035	31X0170	PIN FT Ø6	01/03/1996-
036	32M2561	FAN Ø335	09/06/1998-
037	32M3820	MOTOR	01/03/1996-
038	32W0210	OVEN LAMP 25 W	01/03/1996-
039	32W2561	LAMP HOLDER	01/03/1996-
040	32W3340	MICROSWITCH	14/11/1999-
041	6300645	GLASS + WASHER	04/08/2004-
042	32X0120	GROMMET Ø 21	01/03/1996-
043	32X0130	GROMMET Ø29-Ø37	01/03/1996-
044	32V1010	RELAY	08/04/1998-
044	32V1020	RELAY 1.4-2.3A	08/04/1998-
045	32Z2531	RELAY 240V-50/60HZ	31/12/1997-
045	3100910	RELAY 220/230V- 50/60Hz	01/01/2008-
045	3100910	RELAY 220/230V- 50/60Hz	01/01/2008-
046	32W0450	RED LAMP	01/03/1996-
047	33D2410	"SOLENOID VALVE 3/4"" 1IN-2OUT"	10/05/1999-
048	32W2250	ORANGE LIGHT 220V	01/03/1996-

Pos	Code	Description	Info
049	32Z0151	THERMOMETER	01/03/1996-
050	33Q5410	VALVE CONNECTOR	01/03/1996-
051	33Q5420	"ELBOW FF 3/4""	01/03/1996-
052	33Q5450	DEPRES. CONNECTOR	01/03/1996-
053	33Q5830	CONNECT.	01/03/1996-
054	33Q5592	NOZZLE SUPPORT. ELBOW	01/03/1996-
055	33Q5840	"PLUG 1/8""	01/03/1996-
056	33Q5690	BUSHING SUPPORT	01/03/1996-
057	33Q5980	SOUND REDUC. CONNECTOR	01/03/1996-
058	33T3720	NOZZLE	01/03/1996-
059	35C2670	INSULATION PANEL COVER	01/03/1996-
060	35B4760	INS. PANEL COVERING	01/03/1996-
061	35B4821	INSULATION PANEL	01/03/1996-
062	35B4782	COVER BACK PANEL	01/03/1996-
063	35C2521	RH PANEL	01/03/1996-
064	3AQ0100	COMPON. PROTECTION	01/03/1996-
065	3033400	FILTER	01/03/1996-
066	35Q8202	PANEL BOARD	20/03/2001-
067	35Q2380	END RUN PROTECTION	01/03/1996-
070	35S6082	FLAT BRACKET	21/05/1996-
071	6300420	LOCK ASS. Y	01/03/1996-
072	35V8081	LAMPHOLDER SUPPORT	01/03/1996-
073	32D0260	LOCK NUT PG29	01/03/1996-
074	33Q5921	CONNECTOR	01/03/1996-
075	32D1740	TERMINAL	24/01/2002-
076	35V5810	OMEGA BRACKET	01/03/1996-
077	35X0540	DRAIN PIPE	01/03/1996-
078	35X0550	PIPE	01/03/1996-
079	33M1170	PIPE	01/02/1998-
080	36A3390	DRAIN TRAP	01/03/1996-
081	36A3400	DRAIN	01/03/1996-
082	36D5732	FOOT	13/03/2009-
084	36D7140	BUSHING	01/03/1996-
085	36G5320	SPRING	01/03/1996-
087	6300591	VALVE	31/12/2005-
088	36G6740	COUNTERWEIGHT	01/03/1996-
089	36G6041	END RUN PIN	20/01/2000-
090	32X0140	GROMMET Ø13,5-Ø25	01/03/1996-
091	36Q1171	LOCKNUT M16X1.5	01/03/1996-
092	37Q3011	GASKET	01/03/1996-
093	3151730	GASKET	01/03/1996-
094	37Q7840	GASKET	01/03/1996-
095	3AA1001	CONTROL BOARD ASS.Y	01/03/1996-
096	35V5212	LH FOOT HOLDER	01/03/1996-
097	30T6590	SMALL END SUPPORT	01/03/1996-
098	6300417	DOOR ASSEMBLY	01/03/1996-
099	35V9050	HANDLE SHAPED BAR	01/03/1996-
100	30G0401	DOOR ASS. Y	01/03/1996-
101	35G0360	OVEN COUNTER DOOR	01/03/1996-
103	35V4420	PLATE	01/03/1996-
104	36D8360	MICROSWITCH ROD	01/03/1996-

Pos	Code	Description	Info
105	36M4122	DOOR HINGE	01/03/1996-
106	35Q2360	SUPP. END RUN PROTECTION	01/03/1996-
107	37M0250	CHAMBER GLASS ASS. Y	01/03/1996-
108	37Q0972	DOOR GASKET	23/03/1999-
109	37Q2992	GASKET	10/03/1999-
110	35V0790	FLAT BRACKET	01/03/1996-
111	35V3290	SPILLAGE TRAY SUPPORT	01/03/1996-
112	35V8072	LAMP HOLDER BOX	01/03/1996-
113	35V9030	CHAMBER GLASS SUPP.	01/03/1996-
114	35X2900	DOOR DRAIN PIPE	01/03/1996-
115	33Q6091	H2O FILTER 3/4"	01/03/1996-
116	36G7140	SPRING	01/03/1996-
118	36M0820	LOCK HOUSING	01/03/1996-
119	3150790	THERMOSTAT	01/03/1996-
120	3170290	PROTECT. KNOB SPRING	01/03/1996-
121	32W0490	SWITCH	01/03/1996-
122	35Q6360	THERMORES. PROTECTION	01/03/1996-
123	3111950	SAFETY THERMOSTAT	29/10/2008-
124	32Z5820	THERMOSTAT 50-250° C	01/03/1996-
125	37M4201	PLASTIC COATED PANEL	01/03/1996-
126	32Z2200	TIMER 0-120'	01/03/1996-
126	32Z6440	TIMER 0-120 60HZ	01/03/1996-
127	36Q1320	PLUG	01/03/1996-
128	37Q3220	GASKET	01/03/1996-
129	32Z5880	THERMOSTAT 30-90°C	01/03/1996-
130	36D7062	PIN	07/10/2014-
131	36M4560	ELECTRIC CONTROL KNOB	01/03/1996-
132	33Q3210	PLUG	01/03/1996-
133	33Q5381	RING SUPPORT	01/03/1996-
134	33Q5390	"RING 3/4""	01/03/1996-
135	33Q4120	CONNECT. M16X1.1M10	14/11/1999-
136	33Q5610	RING M16X1.5	01/03/1996-
137	33Q5630	CONNECT MF 3/8"- M16	01/03/1996-
138	36D8492	FEELER SUPPORT	01/03/1996-
139	35S6361	L" SHAPED BAR	29/04/1996-
140	36E2530	PLASTIC INSERT LOCK	01/03/1996-
143	33Q5910	CONNECTOR Ø 0.6	01/03/1996-
144	3190040	SCREW M6X20	01/03/1996-
145	36M1570	LOCK SPACER	01/03/1996-
146	35S8850	"L" BRACKET	01/03/1996-
147	36Q0190	Cap Ø20	01/03/1996-
148	36Q0550	LOCK NUT M12X1.5	01/03/1996-
149	32D0210	FAILED	01/03/1996-
150	32G1701	HEATING ELEMENT 16.4KW230V	01/03/1996-
151	35Q1450	HEAT ELEMENT BRACKET	01/03/1996-
152	36M6380	OVEN DOOR HANDLE	05/05/1999-
153	32Z3361	RELAY 220V-50/60HZ	01/03/1996-
153	32Z3511	RELAY 230V-50HZ	01/03/1996-
153	32Z5990	RELAY 240V-50HZ	01/03/1996-
154	32Q1271	EL. CABLES FCE	01/03/1996-
155	32Q3690	CABLES FCV101E/EDS/EDM	01/03/1996-

<b>Pos</b>	<b>Code</b>	<b>Description</b>	<b>Info</b>
156	36Q1550	CAP Ø11	22/01/1998-
157	36C3071	M6 TRAY HOLDER PIN	18/11/2004-
158	35Y0570	WATER ENTRY	01/06/1998-
159	35Y0530	PROFILE LEFT TRAY GUIDE	01/06/1998-
160	30T3370	RIGHT TRAYS GUIDE ASSEMBLY	01/06/1998-
161	33D2470	SOL. VALVE SUPP.	10/05/1999-