

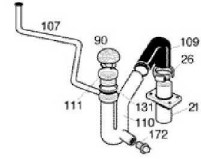

FC241

Edition 20101123-

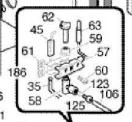
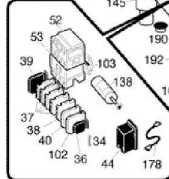
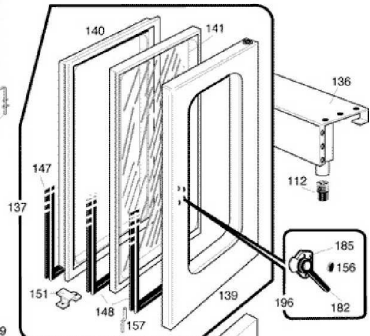
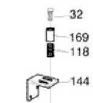
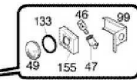
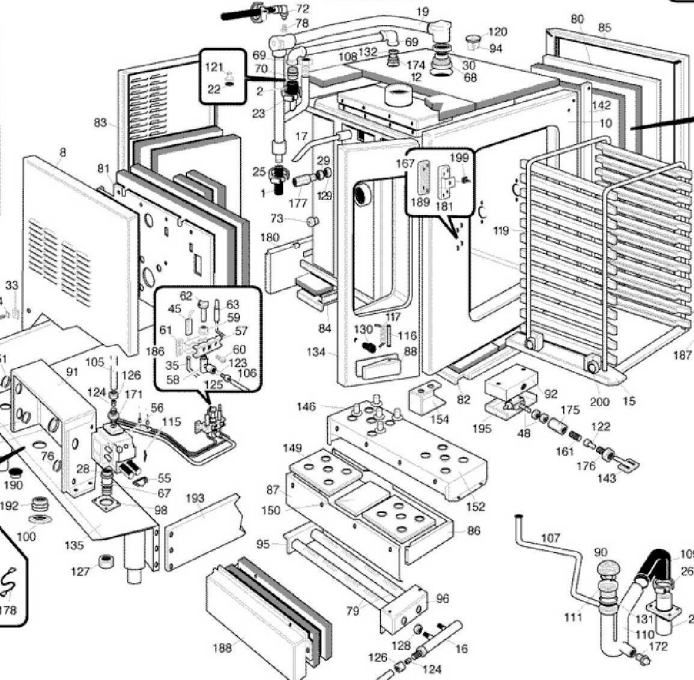
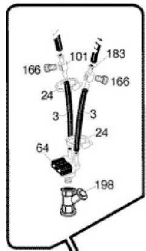
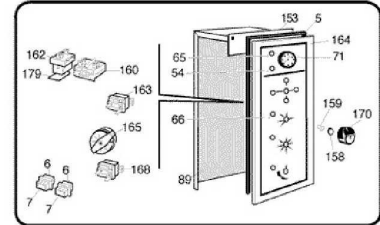
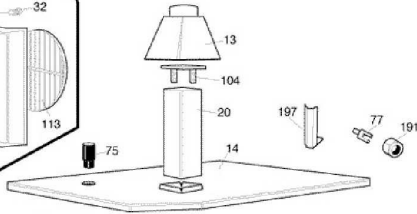
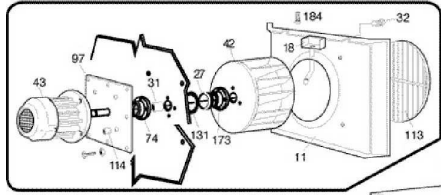

Pos	Code	Description	Info
001	111AA05	RUBBER HOSE Ø30 Ø20	01/03/1995-
002	131AA23	RUBBER HOSE Ø35 Ø28	01/03/1995-
003	131AA52	WATER PIPE Ø10-Ø17	01/03/1995-
004	3188650	WASHER	23/11/2010-
005	137AA15	GASKET	01/03/1995-
006	170WR01	JUNCTION BOX	01/03/1995-
007	171WR01	JUNCTION BOX	01/03/1995-
008	35C3711	LH PANEL ASS.Y	22/01/1998-
009	30W3260	LOWER TRAY ASS.Y	01/03/1995-
010	30D1730	COOKING CHAMBER	01/03/1995-
011	35D8240	CHAMBER CONVEYOR	01/03/1995-
012	30D3811	FLUE ASS. Y	01/03/1995-
013	30D1782	FLAME DEFLECTOR	01/03/1995-
014	3AG0260	OVEN COVER ASS. Y	01/03/1995-
015	30T5581	FRAME ASS. Y	01/03/1995-
016	30Z7780	GAS MANIFOLD ASS. Y	01/03/1995-
017	30Z0490	WATER INLET PIPE ASS.Y	01/03/1995-
018	30Z2090	PIPE ASSEMBLY	01/06/1998-
019	30Z7771	STEAM DRAIN PIPE	01/03/1995-
020	30Z7700	DRAIN PIPE ASS. Y	01/03/1995-
021	33Q6100	LOWER DRAIN PIPE	01/03/1995-
022	36G6750	RING NUT	01/03/1995-
023	3140300	HOSE CLAMP	10/01/1997-
024	3140230	12/20 PIPE CLAMP	01/03/1995-
025	3140300	HOSE CLAMP	01/03/1995-
026	3140380	HOSE CLAMP	01/03/1995-
027	3150900	GASKET	01/03/1995-
028	3151060	"O" RING Ø 28,25	01/03/1995-
029	3151440	WASHER	01/03/1995-
030	3151450	WASHER	01/03/1995-
031	3151490	BEARING	01/03/1995-
032	3190020	SCREW M6X10	01/03/1995-
033	3170110	ACCOMODATION Ø6	01/03/1995-
034	3201540	FUSE 5X20	01/03/1995-
035	32A0390	CABLE "HF" 1200MM	01/03/1995-
036	32D0870	TERMINAL CLAMP	01/03/1995-
037	32D0950	LIVE TERMINAL	01/03/1995-
038	32D0970	GROUND TERMINAL	01/03/1995-
039	32D0960	TERMINAL END COVER	01/03/1995-
040	32D0641	FUSE TERMINAL BOARD	01/03/1995-
041	31X0170	PIN FT Ø6	01/03/1995-
042	32M3991	FAN Ø 400	01/03/1995-
043	32M3820	MOTOR	01/03/1995-
044	32T0041	SPARK IGNITION DEVICE	01/03/1995-
045	32T0010	IGNITION PLUG	27/01/2010-
046	32W0210	OVEN LAMP 25 W	01/03/1995-
047	32W2561	LAMP HOLDER	01/03/1995-
048	32W3020	MICRO SWITCH	01/03/1995-
049	6300645	GLASS + WASHER	04/08/2004-
050	32X0120	GROMMET Ø 21	01/03/1995-
051	32X0130	GROMMET Ø29-Ø37	01/03/1995-

Pos	Code	Description	Info
052	32V1010	RELAY	08/04/1998-
052	32V1020	RELAY 1.4-2.3A	08/04/1998-
053	32Z2081	RELAY 230V-50HZ	01/03/1995-
053	32Z2311	RELAY 220V-50/60HZ	01/03/1995-
053	32Z2531	RELAY 240V-50/60HZ	31/12/1997-
054	32W0101	GREEN LIGHT	01/03/1995-
055	33A0020	COMPL. VALVE	01/03/1995-
056	33A0530	"GAS VALVE 3/4""	01/03/1995-
057	33A0950	REAR BRACKET	01/03/1995-
058	33A2900	PILOT BURNER BODY	01/03/1995-
059	33A0970	RING NUT	01/03/1995-
060	33A0980	SCREW 3/16W. X18TE	01/03/1995-
061	33A1000	FRONT BRACKET	01/03/1995-
062	33A1081	THREE-FLAME BURNER	24/04/2008-
063	6021770	INTERRUPTED THERMOC. M9X1X1000 CAB	01/06/2001-
064	33D1641	SOLENOID VALVE 50/60HZ	01/03/1995-
065	32W0450	RED LAMP	01/03/1995-
066	32W2250	ORANGE LIGHT 220V	01/03/1995-
067	33Q5400	GAS INLET CONNECTOR	01/03/1995-
068	33Q5410	VALVE CONNECTOR	01/03/1995-
069	33Q5420	"ELBOW FF 3/4""	01/03/1995-
070	33Q5450	DEPRES. CONNECTOR	01/03/1995-
071	32Z0151	THERMOMETER	01/03/1995-
072	33Q5591	NOZZLE SUPPORT . ELBOW	01/03/1995-
073	33Q5830	CONNECT.	01/03/1995-
074	33Q5690	BUSHING SUPPORT	01/03/1995-
075	33Q5980	SOUND REDUC. CONNECTOR	01/03/1995-
076	32X0200	GROMMET Ø7.5-Ø11.5	01/03/1995-
077	36D8492	FEELER SUPPORT	01/03/1995-
078	33T3720	NOZZLE	01/03/1995-
079	34A1700	BURNER 15 KW	01/03/1995-
080	35C2700	INSULATION PANEL COVER	01/03/1995-
081	35B8480	INSULATION PANEL COVER	01/03/1995-
082	35B8490	INSULATION PANEL COVER	01/03/1995-
083	35C4310	BACK PANEL	01/03/1995-
084	35B8510	"L" BRACKET	01/03/1995-
085	35C3190	RIGHT PANEL	01/03/1995-
086	35D1830	HALF COMBUSTION CHAMBER	01/03/1995-
087	35D1840	HALF COMBUSTION CHAMBER	01/03/1995-
088	35G4260	SLOT COVER	01/03/1995-
089	3AQ0100	COMPON. PROTECTION	01/03/1995-
090	3033400	FILTER	01/03/1995-
091	35Q8200	PANEL BOARD	01/03/1995-
092	35Q2380	END RUN PROTECTION	01/03/1995-
095	35S6010	BACK BURNER SUPPORT	01/03/1995-
096	35S6021	FRONT BURNER SUPPORT	01/03/1995-
097	35S6082	FLAT BRACKET	21/05/1996-
098	35S6690	FLAT BRACKET	01/03/1995-
099	35V8080	LAMPHOLDER SUPPORT	01/03/1995-
100	32D0200	LOCK NUT PG16	01/03/1995-
101	33Q5920	LOCK NUT PG16	01/03/1995-

Pos	Code	Description	Info
102	32D0651	TERMINAL	01/03/1995-
103	35V5810	OMEGA BRACKET	01/03/1995-
104	35T6710	AIR DEFLECTOR	01/03/1995-
105	35X0800	BURNER PIPE	01/03/1995-
106	35X1101	PIPE	05/03/1996-
107	35X0750	DRAIN PIPE	01/03/1995-
108	35X0550	PIPE	01/03/1995-
109	33M1170	PIPE	01/02/1998-
110	36A3390	DRAIN TRAP	01/03/1995-
111	36A3400	DRAIN	01/03/1995-
112	36D2760	EXAGONAL FOOT SCREW	01/03/1995-
113	36D8850	FAN GUARD	01/03/1995-
114	36D7140	BUSHING	01/03/1995-
115	36G3690	SPRING	01/03/1995-
116	36G5150	PIN	01/03/1995-
117	36G5180	SPRING	01/03/1995-
118	36G5320	SPRING	01/03/1995-
119	36G6143	TROLLEY	08/11/1996-
120	6300591	VALVE	31/12/2005-
121	36G6740	COUNTERWEIGHT	01/03/1995-
122	36G6040	END RUN PIN	01/03/1995-
124	36Q0310	BICONE Ø 14 X 10	01/03/1995-
126	36Q0210	Ø 6 BICONE NUT Ø 14	01/03/1995-
127	36Q1100	LOCK NUT 3/4"	01/03/1995-
128	36Q1110	LOCK NUT 3/8"	01/03/1995-
129	36Q1171	LOCKNUT M16X1.5	01/03/1995-
130	36Q1240	PLUG	01/03/1995-
131	37Q3011	GASKET	01/03/1995-
132	37Q3180	GASKET	01/03/1995-
133	37Q7840	GASKET	01/03/1995-
134	3AA1011	CONTROL BOARD ASS.Y	01/03/1995-
135	30T5712	SMALL END SUPPORT	01/03/1995-
136	30T5724	SMALL END SUPPORT	01/03/1995-
137	6300419	DOOR ASSEMBLY	01/03/1995-
138	32Z6080	CONDENSER	01/03/1995-
139	30G1460	DOOR ASS. Y	01/03/1995-
140	35G0380	OVEN COUNTER DOOR	01/03/1995-
141	37M0270	CHAMBER GLASS ASS.Y	01/03/1995-
142	35V4430	PLATE	01/03/1995-
143	36D8360	MICROSWITCH ROD	01/03/1995-
144	36M4122	DOOR HINGE	01/03/1995-
145	32X0140	GROMMET Ø13,5-Ø25	01/03/1995-
146	33Q6230	BUSHING	01/03/1995-
147	37Q0992	DOOR GASKET	01/03/1995-
148	37Q3001	GLASS GASKET	01/03/1995-
149	35D1900	COMB. CHAMBER SCREEN	01/03/1995-
150	35D2230	SUPPORT COMB. CHAMBER	01/03/1995-
151	35V9030	CHAMBER GLASS SUPP.	01/03/1995-
152	35T0100	COMB. CHAMBER SUPPORT ASS.Y	01/03/1995-
153	35V0790	FLAT BRACKET	01/03/1995-
154	35V3330	SPILLAGE TRAY SUPP. LH	01/03/1995-

Pos	Code	Description	Info
155	35V8071	LAMP HOLDER BOX	01/03/1995-
156	37M4040	RATING INSERT	01/03/1995-
157	35X2900	DOOR DRAIN PIPE	01/03/1995-
158	3150790	THERMOSTAT PROTECT.	01/03/1995-
159	3170290	KNOB SPRING	01/03/1995-
160	32W0490	SWITCH	01/03/1995-
161	36G7140	SPRING	01/03/1995-
162	3111950	SAFETY THERMOSTAT	29/10/2008-
163	32Z5820	THERMOSTAT 50-250° C	01/03/1995-
164	37M4201	PLASTIC COATED PANEL	01/03/1995-
165	32Z2200	TIMER 0-120'	01/03/1995-
165	32Z6440	TIMER 0-120 60HZ	01/03/1995-
166	33Q5840	"PLUG 1/8""	01/03/1995-
167	6300420	LOCK ASS. Y	01/03/1995-
168	32Z5880	THERMOSTAT 30-90°C	01/03/1995-
169	36D7060	PIN	01/03/1995-
170	36M4560	ELECTRIC CONTROL KNOB	01/03/1995-
171	33Q5770	CONNECT. R3/ 4- M22X 1.5	01/03/1995-
172	33Q3210	PLUG	01/03/1995-
173	33Q5381	RING SUPPORT	01/03/1995-
174	33Q5390	"RING 3/4""	01/03/1995-
175	33Q5620	CONNECT M16X1.5 M10	01/03/1995-
176	33Q5610	RING M16X1.5	01/03/1995-
177	33Q5630	CONNECT MF 3/8"- M16	01/03/1995-
178	32A1640	CABLE "HF" 150MM	01/03/1995-
179	35S6361	L" SHAPED BAR	29/04/1996-
180	30T1500	COMB. CHAMBER SUPPORT ASS.Y	01/03/1995-
181	36M0820	LOCK HOUSING	01/03/1995-
183	33Q6080	CONNECTOR Ø 0.7	01/03/1995-
184	3190040	SCREW M6X20	01/03/1995-
186	6300427	PILOT BURNER ASS. Y	01/03/1995-
187	3FL0005	PIN	01/03/1995-
188	35B8540	INS. PANEL COVERING	01/03/1995-
189	36M1570	LOCK SPACER	01/03/1995-
190	36Q0380	PLUG Ø38	01/03/1995-
191	36Q0550	LOCK NUT M12X1.5	01/03/1995-
192	32D0190	FAIRLEAD Ø 6 Ø 16	01/03/1995-
193	35B8931	FRONT PANEL	01/03/1995-
194	35B8942	BACK PANEL	01/03/1995-
195	35Q2360	SUPP. END RUN PROTECTION	01/03/1995-
196	36M3180	HINGE ASS. Y	01/06/1997-
197	35Q6360	THERMORES. PROTECTION	01/03/1995-
198	33Q6090	FILTER	01/03/1995-
199	36E2530	PLASTIC INSERT LOCK	01/03/1995-
200	3FL1256	WHEEL ASS. Y	01/03/1995-
201	32Q1260	EL. CABLES FC	01/03/1995-
202	36Q1550	CAP Ø11	22/01/1998-