

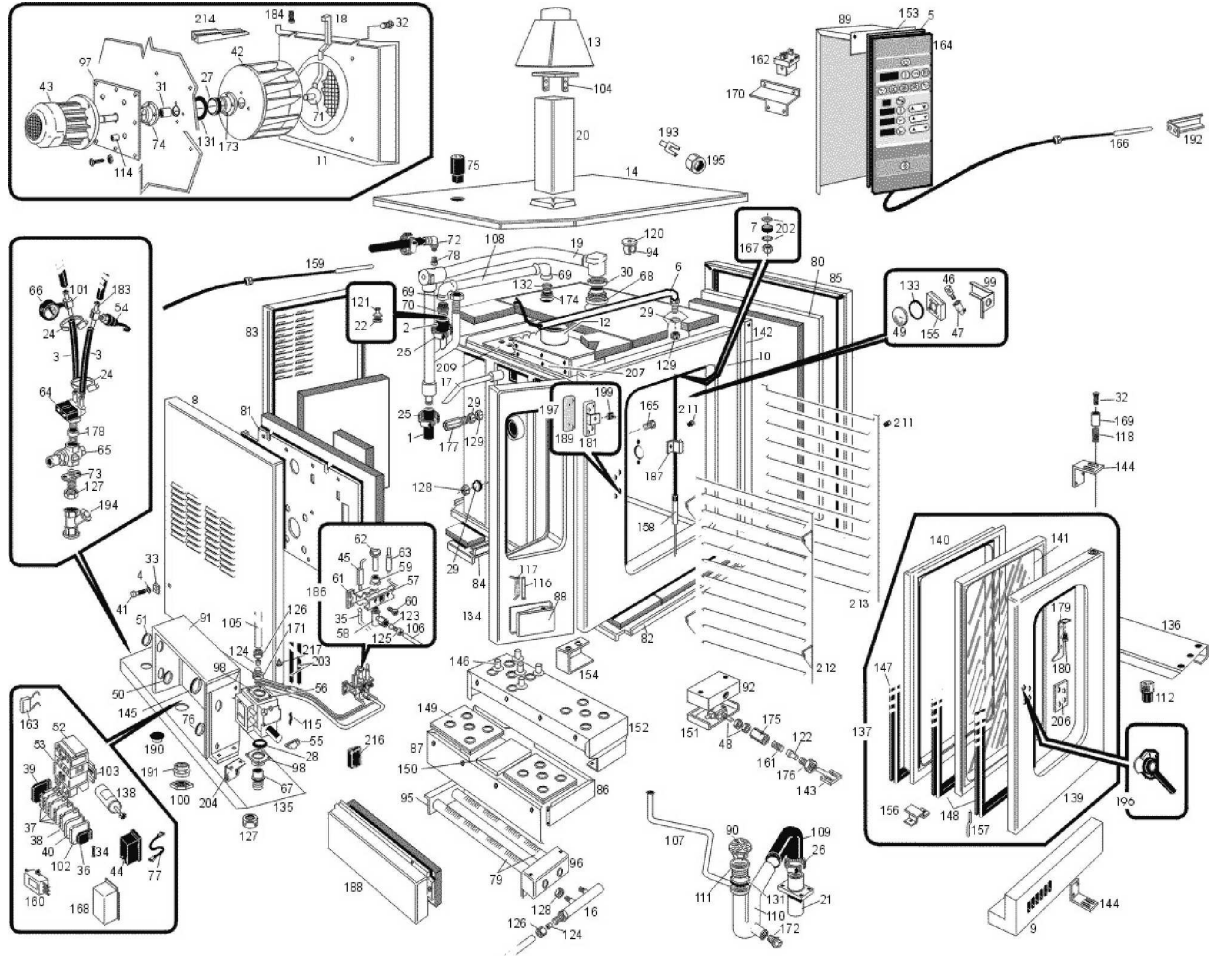

FCV101DS

Edition 20141007-

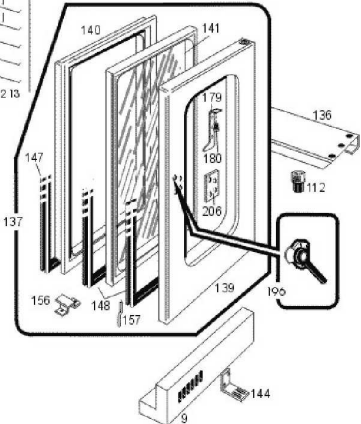
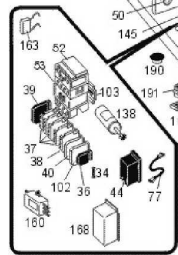
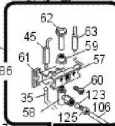
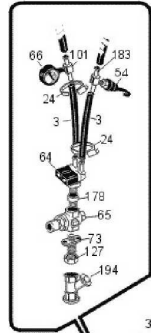
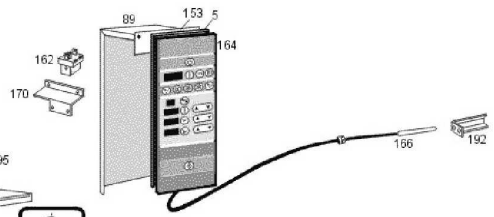
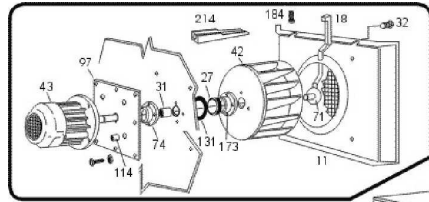

Pos	Code	Description	Info
001	111AA05	RUBBER HOSE Ø30 Ø20	01/03/1996-
002	131AA23	RUBBER HOSE Ø35 Ø28	01/03/1996-
003	131AA12	RUBBER HOSE Ø17 Ø10 X H ² O	01/03/1996-
004	3188650	WASHER	23/11/2010-
005	137AA15	GASKET	01/03/1996-
006	30Z0990	PROBE PIPE ASS. Y	01/03/1996-
007	3150220	GASKET	01/03/1996-
008	35C3691	LH PANEL ASS.Y	22/01/1998-
009	30W3281	TRAY ASS.Y	17/03/1999-
010	30D5680	COOKING CHAMBER	01/06/1998-
011	35Y0580	CHAMBER AIR GUIDE	01/06/1998-
012	30D2673	FLUE ASS. Y	21/01/1999-
013	30D2701	FLAME DEFLECTOR	01/03/1996-
014	30G2900	OVEN COVER ASS. Y	01/03/1996-
016	30Z7590	GAS MANIFOLD	01/03/1996-
017	30Z2050	PIPE AISI304 Ø12-	01/06/1998-
018	30Z2060	159X77 END PIPE, COMPLETE	01/06/1998-
019	30Z7691	STEAM DRAIN PIPE ASS.Y	01/03/1996-
020	30Z7700	DRAIN PIPE ASS. Y	01/03/1996-
021	33Q6100	LOWER DRAIN PIPE	01/03/1996-
022	36G6750	RING NUT	01/03/1996-
023	3140300	HOSE CLAMP	10/01/1997-
024	3140230	12/20 PIPE CLAMP	01/03/1996-
025	3140300	HOSE CLAMP	01/03/1996-
026	3140380	HOSE CLAMP	01/03/1996-
027	3150900	GASKET	01/03/1996-
028	3152300	O RING GASKET	17/03/2000-
029	3151441	WASHER Ø22 Ø16.2=1.5 CU	14/10/1998-
030	3151450	WASHER	01/03/1996-
031	3151490	BEARING	01/03/1996-
032	3190020	SCREW M6X10	01/03/1996-
033	3170110	ACCOMODATION Ø6	01/03/1996-
034	3201540	FUSE 5X20	01/03/1996-
035	32A1600	CABLE "HF" 1200MM	01/03/1996-
036	32D0870	TERMINAL CLAMP	01/03/1996-
037	32D0950	LIVE TERMINAL	01/03/1996-
038	32D0970	GROUND TERMINAL	01/03/1996-
039	32D0960	TERMINAL END COVER	01/03/1996-
040	32D1730	FUSE TERMINAL BOARD	24/01/2002-
041	31X0170	PIN FT Ø6	01/03/1996-
042	32M2561	FAN Ø335	09/06/1998-
043	32M3820	MOTOR	01/03/1996-
044	32T0210	SPARK IGNITION DEVICE	20/03/2001-
045	32T0010	IGNITION PLUG	27/01/2010-
046	32W0210	OVEN LAMP 25 W	01/03/1996-
047	32W2561	LAMP HOLDER	01/03/1996-
048	32W3340	MICROSWITCH	14/11/1999-
049	6300645	GLASS + WASHER	04/08/2004-
050	32X0120	GROMMET Ø 21	01/03/1996-
051	32X0130	GROMMET Ø29-Ø37	01/03/1996-
052	32V1010	RELAY	08/04/1998-

Pos	Code	Description	Info
052	32V1020	RELAY 1.4-2.3A	08/04/1998-
053	32Z2531	RELAY 240V-50/60HZ	31/12/1997-
053	3100910	RELAY 220/230V- 50/60Hz	01/01/2008-
053	3100910	RELAY 220/230V- 50/60Hz	01/01/2008-
054	3041830	PRESSURESTAT	30/09/2004-
055	33A0020	COMPL. VALVE	01/03/1996-
056	33A0460	"GAS THERMOST. NOVASIT 820 1/2""	17/03/2000-
057	33A0950	REAR BRACKET	01/03/1996-
058	33A2900	PILOT BURNER BODY	01/03/1996-
059	33A0970	RING NUT	01/03/1996-
060	33A0980	SCREW 3/16W. X18TE	01/03/1996-
061	33A1000	FRONT BRACKET	01/03/1996-
062	33A1081	THREE-FLAME BURNER	24/04/2008-
063	6021770	INTERRUPTED THERMOC. M9X1X1000 CAB	01/06/2001-
064	33D2410	"SOLENOID VALVE 3/4"" 1IN-2OUT"	10/05/1999-
065	33D1650	"PRES. REDUC. VAL. F-F Ø 1/2""	01/03/1996-
066	33D1680	MANOMETRE 0-40BAR M1/8	01/03/1996-
067	33Q3870	GAS INLET CONNECTOR	17/03/2000-
068	33Q5410	VALVE CONNECTOR	01/03/1996-
069	33Q5420	"ELBOW FF 3/4""	01/03/1996-
070	33Q5450	DEPRES. CONNECTOR	01/03/1996-
071	30Z0480	WATER DIFFUSER	01/03/1996-
072	33Q5592	NOZZLE SUPPORT. ELBOW	01/03/1996-
073	33Q5641	ENTRY CONNECTOR H2O	01/03/1996-
074	33Q5690	BUSHING SUPPORT	01/03/1996-
075	33Q5980	SOUND REDUC. CONNECTOR	01/03/1996-
076	32X0200	GROMMET Ø7.5-Ø11.5	01/03/1996-
077	32A1640	CABLE "HF" 150MM	01/03/1996-
078	33T3720	NOZZLE	01/03/1996-
079	34A1690	BURNER 9 KW	01/03/1996-
080	35C2670	INSULATION PANEL COVER	01/03/1996-
081	35B4760	INS. PANEL COVERING	01/03/1996-
082	35B4771	INSULATION PANEL COVER	01/03/1996-
083	35B4782	BACK PANEL	01/03/1996-
084	35B4790	"L" BRACKET	01/03/1996-
085	35C2521	RH PANEL	01/03/1996-
086	35D1810	FRONT ROOM	01/03/1996-
087	35D1820	BACK ROOM	01/03/1996-
088	35G3180	SLOT COVER	04/02/1997-
089	3AQ0100	COMPON. PROTECTION	01/03/1996-
090	3033400	FILTER	01/03/1996-
091	35Q8202	PANEL BOARD	20/03/2001-
092	35Q2380	END RUN PROTECTION	01/03/1996-
095	35S6010	BACK BURNER SUPPORT	01/03/1996-
096	35S6021	FRONT BURNER SUPPORT	01/03/1996-
096	35V8081	LAMPHOLDER SUPPORT	01/03/1996-
097	35S6082	FLAT BRACKET	21/05/1996-
098	33Q3880	TEE	17/03/2000-
099	35V8081	LAMPHOLDER SUPPORT	01/03/1996-
100	32D0200	LOCK NUT PG16	01/03/1996-
101	33Q5921	CONNECTOR	01/03/1996-

Pos	Code	Description	Info
102	32D1740	TERMINAL	24/01/2002-
103	35V5810	OMEGA BRACKET	01/03/1996-
104	35T6710	AIR DEFLECTOR	01/03/1996-
105	35X0411	PIPE	27/06/2000-
106	35X4590	PILOT BURNER PIPE	17/03/2000-
107	35X0540	DRAIN PIPE	01/03/1996-
108	35X0550	PIPE	01/03/1996-
109	33M1170	PIPE	01/02/1998-
110	36A3390	DRAIN TRAP	01/03/1996-
111	36A3400	DRAIN	01/03/1996-
112	36D5732	FOOT	13/03/2009-
114	36D7140	BUSHING	01/03/1996-
115	36G3690	SPRING	01/03/1996-
116	36G7820	PIN	04/02/1997-
117	36G7960	TORSION SPRING	04/02/1997-
118	36G5320	SPRING	01/03/1996-
120	6300591	VALVE	31/12/2005-
121	36G6740	COUNTERWEIGHT	01/03/1996-
122	36G6041	END RUN PIN	20/01/2000-
123	36Q0020	BICONE Ø 6 X 6.5	01/03/1996-
124	36Q0030	BICONE Ø12X8	01/03/1996-
125	36Q0060	CLOSING BICONE NUT Ø 6	01/03/1996-
126	36Q0050	BICONE NUT Ø 12	01/03/1996-
127	36Q1100	LOCK NUT 3/4"	01/03/1996-
128	36Q1110	LOCK NUT 3/8"	01/03/1996-
129	36Q1171	LOCKNUT M16X1.5	01/03/1996-
131	37Q3011	GASKET	01/03/1996-
132	3151730	GASKET	01/03/1996-
133	37Q7840	GASKET	01/03/1996-
134	30A3910	CONTROL PANEL	04/02/1997-
135	35V5212	LH FOOT HOLDER	01/03/1996-
136	30T6590	SMALL END SUPPORT	01/03/1996-
137	6300429	OVEN DOOR ASS. Y	01/03/1996-
138	32Z6080	CONDENSER	01/03/1996-
139	30G0401	DOOR ASS. Y	01/03/1996-
140	35G0360	OVEN COUNTER DOOR	01/03/1996-
141	37M0250	CHAMBER GLASS ASS. Y	01/03/1996-
142	35V4420	PLATE	01/03/1996-
143	36D8360	MICROSWITCH ROD	01/03/1996-
144	36M4122	DOOR HINGE	01/03/1996-
145	32X0140	GROMMET Ø13,5-Ø25	01/03/1996-
146	33Q6230	BUSHING	01/03/1996-
147	37Q0972	DOOR GASKET	23/03/1999-
148	37Q2992	GASKET	10/03/1999-
149	35D1900	COMB. CHAMBER SCREEN	01/03/1996-
150	35D1970	INSULATING PANEL	01/03/1996-
151	35Q2360	SUPP. END RUN PROTECTION	01/03/1996-
152	35T0710	COMB. CHAMBER SUPPORT ASS.Y	01/03/1996-
153	35V0790	FLAT BRACKET	01/03/1996-
154	35V3290	SPILLAGE TRAY SUPPORT	01/03/1996-
155	35V8072	LAMP HOLDER BOX	01/03/1996-

Pos	Code	Description	Info
156	35V9030	CHAMBER GLASS SUPP.	01/03/1996-
157	35X2900	DOOR DRAIN PIPE	01/03/1996-
158	32Z1983	PIN PROBE PT100	08/03/1999-
159	32Z6041	PT100 PROBE	01/03/1996-
160	32Z6090	FILTER	01/03/1996-
161	36G7140	SPRING	01/03/1996-
162	3111950	SAFETY THERMOSTAT	29/10/2008-
163	32Z6100	FILTER	01/03/1996-
164	32Z6653	ELECTRONIC BOARD	31/01/2003-
165	33Q0530	CAP M. 3/8	01/03/1996-
166	32Z6191	TEMP.PROBE PT100	01/03/1996-
167	33Q0730	CONNECT.	01/03/1996-
168	35Q1730	EL. IGNITION PROTECTION	01/03/1996-
169	36D7062	PIN	07/10/2014-
170	35S2930	"L" BRACKET	01/03/1996-
171	33Q5880	CONNECT. R1/2-	01/03/1996-
172	33Q3210	M20X1.5 PLUG	01/03/1996-
173	33Q5381	RING SUPPORT	01/03/1996-
174	33Q5390	"RING 3/4""	01/03/1996-
175	33Q4120	CONNECT. M16X1.1M10	14/11/1999-
176	33Q5610	RING M16X1.5	01/03/1996-
177	33Q5630	CONNECT MF 3/8"- M16	01/03/1996-
178	33Q5650	SOCKET F3/4 M1/2 Ø30X25	01/03/1996-
179	35V8590	PROBE SUPPORT	01/03/1996-
180	36C1380	BUSHING PROTECT.	01/03/1996-
181	36M0820	PROBE LOCK HOUSING	01/03/1996-
183	33Q5910	CONNECTOR Ø 0.6	01/03/1996-
184	3190040	SCREW M6X20	01/03/1996-
186	6300427	PILOT BURNER ASS. Y	01/03/1996-
187	35Y0690	CABLE CLAMP	01/06/1998-
188	35B4990	INSULATION PANEL COVER	01/03/1996-
189	36M1570	LOCK SPACER	01/03/1996-
190	36Q0380	PLUG Ø38	01/03/1996-
191	32D0190	FAIRLEAD Ø 6 Ø 16	01/03/1996-
192	35Q6360	THERMORES. PROTECTION	01/03/1996-
193	36D8492	FEELER SUPPORT	01/03/1996-
194	33Q6091	H2O FILTER 3/4"	01/03/1996-
195	36Q0550	LOCK NUT M12X1.5	01/03/1996-
196	36M6380	OVEN DOOR HANDLE	05/05/1999-
197	6300420	LOCK ASS. Y	01/03/1996-
199	36E2530	PLASTIC INSERT LOCK	01/03/1996-
202	3120100	WASHER	01/03/1996-
203	32A0780	CABLE	01/03/1996-
204	35R5350	SUPPORT SOLENOID VALVE	17/03/2000-
206	35V9050	HANDLE SHAPED BAR	01/03/1996-
207	35D4872	FLUE PANEL	22/02/1999-
208	32Q3631	EL. CABLES DS	01/03/1996-
209	37Q3880	PIPE GASKET	01/12/1997-
210	36Q1550	CAP Ø11	22/01/1998-
211	36C3071	M6 TRAY HOLDER PIN	18/11/2004-
212	35Y0530	LEFT TRAY GUIDE	01/06/1998-

Pos	Code	Description	Info
213	30T3370	RIGHT TRAYS GUIDE ASSEMBLY	01/06/1998-
214	35Y0570	WATER ENTRY PROFILE	01/06/1998-
215	3152360	WASHER 3/8" 3/8" Ø22-Ø17.2=1.5 CU/NI	14/10/1998-
216	32D1430	CONNECTOR	17/03/2000-
217	33D2140	PIN VALVE	17/03/2000-