

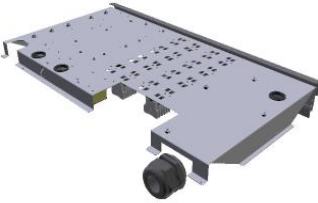



Codice assieme	Descrizione assieme	Immagine assieme
ASM1809A/0.D01	Impianto elettrico	
ASM1817A/0.D04	Porta	
ASM1800A/0.D02	Copertura esterna	
ASM1804A/0.D02	Camera di cottura	

ASM1809A/0.D01 - Impianto elettrico

FRONTE



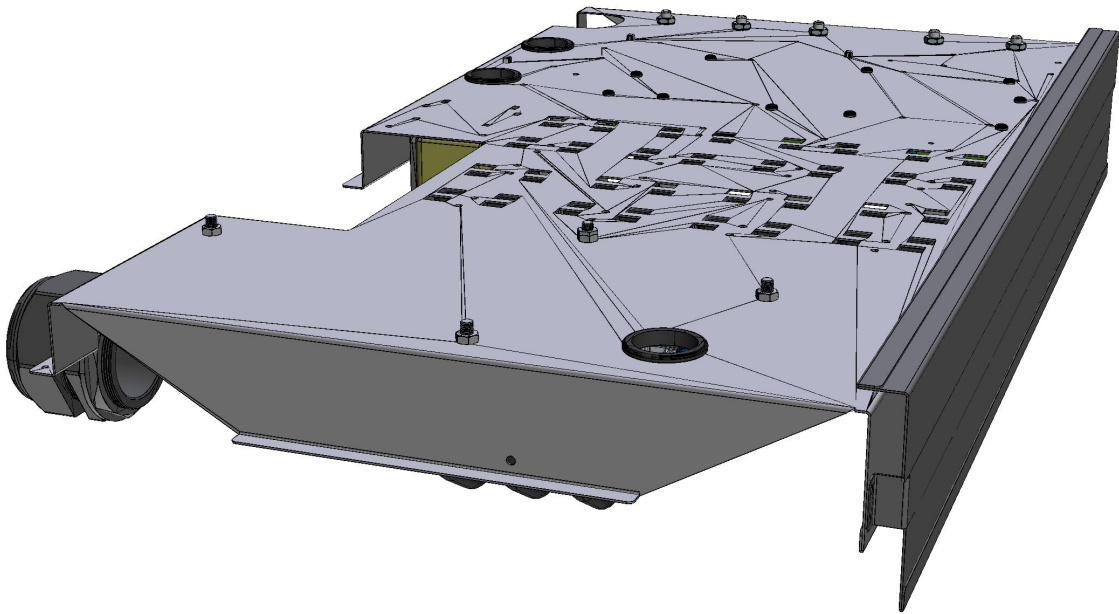

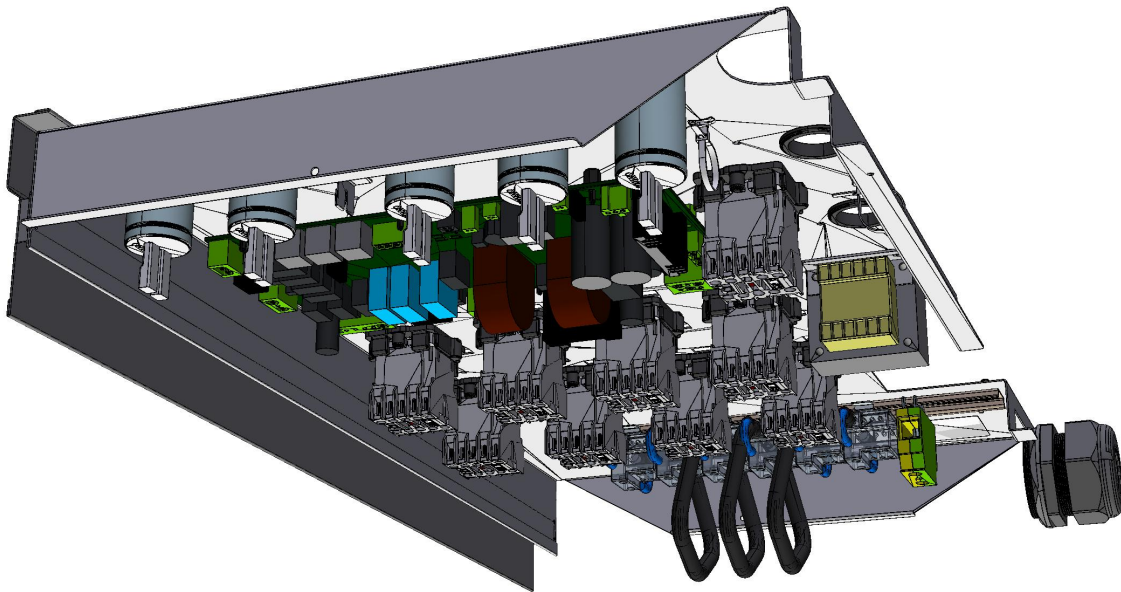

ASM1809A/0.D01 - Impianto elettrico

RETRO

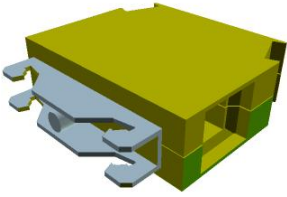

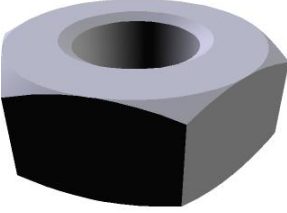
COMPONENTE			RICAMBIO																		
Codice	Descrizione	Immagine	Codice	Descrizione	Lista componenti																
CN1003A	CONDENSATORE CORAZZATO 6,3 UF		KCN1003A	KIT CONDENSATORE MOTORE 6,3 UF	<table border="1"> <thead> <tr> <th>Codice</th> <th>Descrizione</th> <th>Qtà</th> <th>UM</th> </tr> </thead> <tbody> <tr> <td>CN1003A0</td> <td>CONDENSATO RE CORAZZATO 6,3 UF</td> <td>1</td> <td>PZ</td> </tr> <tr> <td>VI1931A0</td> <td>DADO M8X1.65 H4 CH13 ZINCATO</td> <td>1</td> <td>PZ</td> </tr> <tr> <td>VI1932A0</td> <td>RONDELLA DENTELLATA D8 ZINCATA</td> <td>1</td> <td>PZ</td> </tr> </tbody> </table>	Codice	Descrizione	Qtà	UM	CN1003A0	CONDENSATO RE CORAZZATO 6,3 UF	1	PZ	VI1931A0	DADO M8X1.65 H4 CH13 ZINCATO	1	PZ	VI1932A0	RONDELLA DENTELLATA D8 ZINCATA	1	PZ
Codice	Descrizione	Qtà	UM																		
CN1003A0	CONDENSATO RE CORAZZATO 6,3 UF	1	PZ																		
VI1931A0	DADO M8X1.65 H4 CH13 ZINCATO	1	PZ																		
VI1932A0	RONDELLA DENTELLATA D8 ZINCATA	1	PZ																		
VE1115A	MINICONTATTORE QUADRIPOLORE 20 A 230V		KVE1115A	KIT MINICONTATTORE QUADRIPOLORE 20A 230V	<table border="1"> <thead> <tr> <th>Codice</th> <th>Descrizione</th> <th>Qtà</th> <th>UM</th> </tr> </thead> <tbody> <tr> <td>VE1115A0</td> <td>MINICONTATT ORE QUADRIPOLO RE 20 A 230V</td> <td>1</td> <td>PZ</td> </tr> <tr> <td>VM1075A1</td> <td>CLIP DI FISSAGGIO PER TELERUTTORI</td> <td>4</td> <td>PZ</td> </tr> </tbody> </table>	Codice	Descrizione	Qtà	UM	VE1115A0	MINICONTATT ORE QUADRIPOLO RE 20 A 230V	1	PZ	VM1075A1	CLIP DI FISSAGGIO PER TELERUTTORI	4	PZ				
Codice	Descrizione	Qtà	UM																		
VE1115A0	MINICONTATT ORE QUADRIPOLO RE 20 A 230V	1	PZ																		
VM1075A1	CLIP DI FISSAGGIO PER TELERUTTORI	4	PZ																		
VM1056A	STAFFA TELERUTTORE PICCOLO VE1115A		VM1056A0	STAFFA TELERUTTORE PICCOLO VE1115A																	
VE1644A	DADO PRESSACAVO PG 29		VE1644A0	DADO PRESSACAVO PG 29																	
CE1420A	MORSETTIERA UNIPOLARE 8 VIE Z16-8D		KCE1420A	KIT MORSETTIERA UNIPOLARE 8 VIE Z16-8D	<table border="1"> <thead> <tr> <th>Codice</th> <th>Descrizione</th> <th>Qtà</th> <th>UM</th> </tr> </thead> <tbody> <tr> <td>CE1420A0</td> <td>MORSETTIER A UNIPOLARE 8 VIE Z16-8D</td> <td>1</td> <td>PZ</td> </tr> </tbody> </table>	Codice	Descrizione	Qtà	UM	CE1420A0	MORSETTIER A UNIPOLARE 8 VIE Z16-8D	1	PZ								
Codice	Descrizione	Qtà	UM																		
CE1420A0	MORSETTIER A UNIPOLARE 8 VIE Z16-8D	1	PZ																		

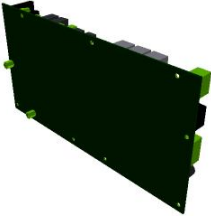
COMPONENTE			RICAMBIO																						
Codice	Descrizione	Immagine	Codice	Descrizione	Lista componenti																				
MR1011A	MORSETTO DI TERRA UL 125A PER BARRA OMEG		KMR1011A	KIT MORSETTO DI TERRA MR1011A0	<table border="1"> <thead> <tr> <th>Codice</th> <th>Descrizione</th> <th>Qtà</th> <th>UM</th> </tr> </thead> <tbody> <tr> <td>MR1011A0</td> <td>MORSETTO DI TERRA UL 125A PER BARRA OMEG</td> <td>1</td> <td>PZ</td> </tr> </tbody> </table>	Codice	Descrizione	Qtà	UM	MR1011A0	MORSETTO DI TERRA UL 125A PER BARRA OMEG	1	PZ												
Codice	Descrizione	Qtà	UM																						
MR1011A0	MORSETTO DI TERRA UL 125A PER BARRA OMEG	1	PZ																						
VE1628A	PRESSACAVO PG 48 RIDOTTO		VE1628A0	PRESSACAVO PG 48 RIDOTTO																					
VI1327A	DADO M6X1 H4 ZN																								
OH7374A	LAMIERINO TAGLIO CAVO SONDA CUOR		OH7374A0	LAMIERINO TAGLIO CAVO SONDA CUOR																					
PE2037A	SCHEDA POTENZA MM ONE		KPE2037A	KIT SCHEDA POTENZA MIND.MAPS ONE	<table border="1"> <thead> <tr> <th>Codice</th> <th>Descrizione</th> <th>Qtà</th> <th>UM</th> </tr> </thead> <tbody> <tr> <td>PE2037A0</td> <td>SCHEDA POTENZA MM ONE</td> <td>1</td> <td>PZ</td> </tr> <tr> <td>VI1850A0</td> <td>VITE M4X6 TCB+ NICHELATA</td> <td>9</td> <td>PZ</td> </tr> <tr> <td>VM1745A0</td> <td>SUPPORTO PER SCHEDA</td> <td>9</td> <td>PZ</td> </tr> <tr> <td>VM2147A0</td> <td>SPUGNA ESD ROSA LISCIA 410X343X15 M</td> <td>1</td> <td>PZ</td> </tr> </tbody> </table>	Codice	Descrizione	Qtà	UM	PE2037A0	SCHEDA POTENZA MM ONE	1	PZ	VI1850A0	VITE M4X6 TCB+ NICHELATA	9	PZ	VM1745A0	SUPPORTO PER SCHEDA	9	PZ	VM2147A0	SPUGNA ESD ROSA LISCIA 410X343X15 M	1	PZ
Codice	Descrizione	Qtà	UM																						
PE2037A0	SCHEDA POTENZA MM ONE	1	PZ																						
VI1850A0	VITE M4X6 TCB+ NICHELATA	9	PZ																						
VM1745A0	SUPPORTO PER SCHEDA	9	PZ																						
VM2147A0	SPUGNA ESD ROSA LISCIA 410X343X15 M	1	PZ																						

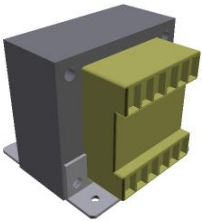
COMPONENTE			RICAMBIO																		
Codice	Descrizione	Immagine	Codice	Descrizione	Lista componenti																
VE1639A	TRASFORMATORE 230-12VAC 60VA		KVE1639A	KIT TRASFORMATORE 230-12VAC 60VA	<table border="1"> <thead> <tr> <th>Codice</th> <th>Descrizione</th> <th>Qtà</th> <th>UM</th> </tr> </thead> <tbody> <tr> <td>VE1639A0</td> <td>TRASFORMAT ORE 230-12VAC 60VA</td> <td>1</td> <td>PZ</td> </tr> <tr> <td>VI1950A0</td> <td>VITE AUTOFORANT E 4,2X13 TCB INOX</td> <td>4</td> <td>PZ</td> </tr> <tr> <td>VM2147A0</td> <td>SPUGNA ESD ROSA LISCIA 410X343X15 M</td> <td>1</td> <td>PZ</td> </tr> </tbody> </table>	Codice	Descrizione	Qtà	UM	VE1639A0	TRASFORMAT ORE 230-12VAC 60VA	1	PZ	VI1950A0	VITE AUTOFORANT E 4,2X13 TCB INOX	4	PZ	VM2147A0	SPUGNA ESD ROSA LISCIA 410X343X15 M	1	PZ
Codice	Descrizione	Qtà	UM																		
VE1639A0	TRASFORMAT ORE 230-12VAC 60VA	1	PZ																		
VI1950A0	VITE AUTOFORANT E 4,2X13 TCB INOX	4	PZ																		
VM2147A0	SPUGNA ESD ROSA LISCIA 410X343X15 M	1	PZ																		

ASM1817A/0.D04 - Porta

FRONTE

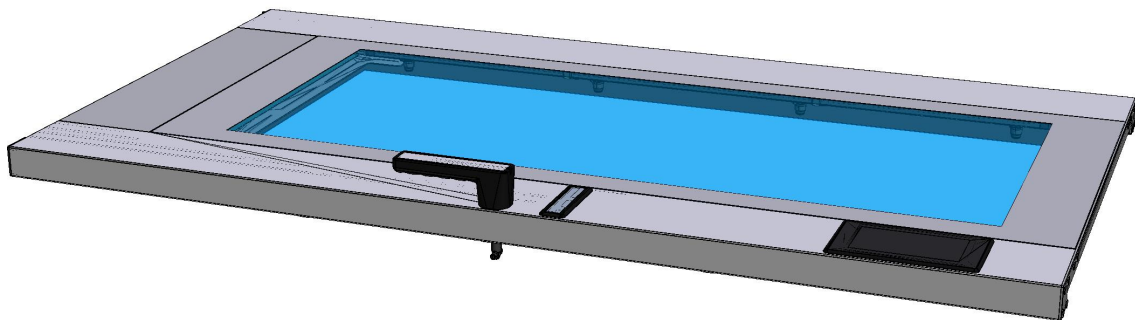

ASM1817A/0.D04 - Porta



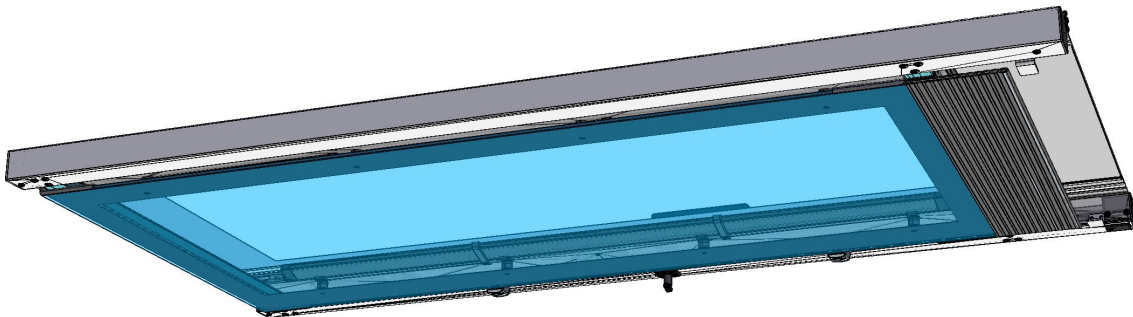

RETRO



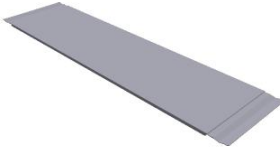

COMPONENTE			RICAMBIO																																																																		
<i>Codice</i>	<i>Descrizione</i>	<i>Immagine</i>	<i>Codice</i>	<i>Descrizione</i>	<i>Lista componenti</i>																																																																
MG1083A	ASSIEME MANIGLIA COMPLETO MM		KMG1083A	KIT MANIGLIA COMPLETA MM	<table border="1"> <thead> <tr> <th><i>Codice</i></th> <th><i>Descrizione</i></th> <th><i>Qtà</i></th> <th><i>UM</i></th> </tr> </thead> <tbody> <tr> <td>0H7321A0</td> <td>PIASTRINA COPERCHIETT O MANIGLIA M</td> <td>1</td> <td>PZ</td> </tr> <tr> <td>RC1200A0</td> <td>MOLLA A COMPRESSIO NE DE4 DF0.5 H24</td> <td>4</td> <td>PZ</td> </tr> <tr> <td>VI0239A1</td> <td>VITE AUTOFIL. 4.2X25 TCB+ INOX</td> <td>4</td> <td>PZ</td> </tr> <tr> <td>VI1220A1</td> <td>VITE AUTOFILETTA NTE 4.2X11 TCS+ MARUTE</td> <td>2</td> <td>PZ</td> </tr> <tr> <td>VM1182B0</td> <td>ATTACCO MANIGLIA CON GUIDA PERNO CT BT</td> <td>1</td> <td>PZ</td> </tr> <tr> <td>VM1182B1</td> <td>ATTACCO MANIGLIA CON GUIDA PERNO CT BT</td> <td>1</td> <td>PZ</td> </tr> <tr> <td>VM1183A1</td> <td>PERNO MANIGLIA CHEFTOP BAKERTOP</td> <td>1</td> <td>PZ</td> </tr> <tr> <td>VM1183B0</td> <td>PERNO MANIGLIA CT BT</td> <td>1</td> <td>PZ</td> </tr> <tr> <td>VM1490A0</td> <td>COPRI VITI MANIGLIA CHEFTOP BAKERTOP</td> <td>2</td> <td>PZ</td> </tr> <tr> <td>VM1695A0</td> <td>PERNO POSIZIONE MANIGLIA</td> <td>4</td> <td>PZ</td> </tr> <tr> <td>VM2245A0</td> <td>IMPUGNATUR A MANIGLIA CON SCROCC</td> <td>1</td> <td>PZ</td> </tr> <tr> <td>VM2247A0</td> <td>COVER IMPUGNATUR A MANIGLIA VM2245-2246</td> <td>1</td> <td>PZ</td> </tr> <tr> <td>VM2248A0</td> <td>CHIAVETTA CHIUSURA MANIGLIA CON SCROCC</td> <td>1</td> <td>PZ</td> </tr> <tr> <td>VM2248B0</td> <td>CHIAVETTA CHIUSURA MANIGLIA CON SCROCC</td> <td>1</td> <td>PZ</td> </tr> <tr> <td>VM2295A0</td> <td>PENNINO PER CONTROLLO MM</td> <td>1</td> <td>PZ</td> </tr> </tbody> </table>	<i>Codice</i>	<i>Descrizione</i>	<i>Qtà</i>	<i>UM</i>	0H7321A0	PIASTRINA COPERCHIETT O MANIGLIA M	1	PZ	RC1200A0	MOLLA A COMPRESSIO NE DE4 DF0.5 H24	4	PZ	VI0239A1	VITE AUTOFIL. 4.2X25 TCB+ INOX	4	PZ	VI1220A1	VITE AUTOFILETTA NTE 4.2X11 TCS+ MARUTE	2	PZ	VM1182B0	ATTACCO MANIGLIA CON GUIDA PERNO CT BT	1	PZ	VM1182B1	ATTACCO MANIGLIA CON GUIDA PERNO CT BT	1	PZ	VM1183A1	PERNO MANIGLIA CHEFTOP BAKERTOP	1	PZ	VM1183B0	PERNO MANIGLIA CT BT	1	PZ	VM1490A0	COPRI VITI MANIGLIA CHEFTOP BAKERTOP	2	PZ	VM1695A0	PERNO POSIZIONE MANIGLIA	4	PZ	VM2245A0	IMPUGNATUR A MANIGLIA CON SCROCC	1	PZ	VM2247A0	COVER IMPUGNATUR A MANIGLIA VM2245-2246	1	PZ	VM2248A0	CHIAVETTA CHIUSURA MANIGLIA CON SCROCC	1	PZ	VM2248B0	CHIAVETTA CHIUSURA MANIGLIA CON SCROCC	1	PZ	VM2295A0	PENNINO PER CONTROLLO MM	1	PZ
<i>Codice</i>	<i>Descrizione</i>	<i>Qtà</i>	<i>UM</i>																																																																		
0H7321A0	PIASTRINA COPERCHIETT O MANIGLIA M	1	PZ																																																																		
RC1200A0	MOLLA A COMPRESSIO NE DE4 DF0.5 H24	4	PZ																																																																		
VI0239A1	VITE AUTOFIL. 4.2X25 TCB+ INOX	4	PZ																																																																		
VI1220A1	VITE AUTOFILETTA NTE 4.2X11 TCS+ MARUTE	2	PZ																																																																		
VM1182B0	ATTACCO MANIGLIA CON GUIDA PERNO CT BT	1	PZ																																																																		
VM1182B1	ATTACCO MANIGLIA CON GUIDA PERNO CT BT	1	PZ																																																																		
VM1183A1	PERNO MANIGLIA CHEFTOP BAKERTOP	1	PZ																																																																		
VM1183B0	PERNO MANIGLIA CT BT	1	PZ																																																																		
VM1490A0	COPRI VITI MANIGLIA CHEFTOP BAKERTOP	2	PZ																																																																		
VM1695A0	PERNO POSIZIONE MANIGLIA	4	PZ																																																																		
VM2245A0	IMPUGNATUR A MANIGLIA CON SCROCC	1	PZ																																																																		
VM2247A0	COVER IMPUGNATUR A MANIGLIA VM2245-2246	1	PZ																																																																		
VM2248A0	CHIAVETTA CHIUSURA MANIGLIA CON SCROCC	1	PZ																																																																		
VM2248B0	CHIAVETTA CHIUSURA MANIGLIA CON SCROCC	1	PZ																																																																		
VM2295A0	PENNINO PER CONTROLLO MM	1	PZ																																																																		

COMPONENTE			RICAMBIO																																																		
Codice	Descrizione	Immagine	Codice	Descrizione	Lista componenti																																																
VM2315A	SUPPORTO SPINGI VETRO INT MM		KVM2315A	KIT SUPPORTO SPINGI VETRO INT MM	<table border="1"> <thead> <tr> <th>Codice</th> <th>Descrizione</th> <th>Qtà</th> <th>UM</th> </tr> </thead> <tbody> <tr> <td>VI1220A1</td> <td>VITE AUTOFISETTA NTE 4.2X11 TCS+ MARUTE</td> <td>3</td> <td>PZ</td> </tr> <tr> <td>VM1630A0</td> <td>TAPPO PREMI VETRO INTERNO</td> <td>3</td> <td>PZ</td> </tr> <tr> <td>VM2315A0</td> <td>SUPPORTO SPINGI VETRO INT MM</td> <td>3</td> <td>PZ</td> </tr> </tbody> </table>	Codice	Descrizione	Qtà	UM	VI1220A1	VITE AUTOFISETTA NTE 4.2X11 TCS+ MARUTE	3	PZ	VM1630A0	TAPPO PREMI VETRO INTERNO	3	PZ	VM2315A0	SUPPORTO SPINGI VETRO INT MM	3	PZ																																
Codice	Descrizione	Qtà	UM																																																		
VI1220A1	VITE AUTOFISETTA NTE 4.2X11 TCS+ MARUTE	3	PZ																																																		
VM1630A0	TAPPO PREMI VETRO INTERNO	3	PZ																																																		
VM2315A0	SUPPORTO SPINGI VETRO INT MM	3	PZ																																																		
VM1630A	TAPPO PREMI VETRO INTERNO		KVM2315A KVM1591A KVM1590A	KIT SUPPORTO SPINGI VETRO INT MM KIT SPINGIVETRO INTERNO H35 S.5E KIT SPINGIVETRO INTERNO H25 S.5	<table border="1"> <thead> <tr> <th>Codice</th> <th>Descrizione</th> <th>Qtà</th> <th>UM</th> </tr> </thead> <tbody> <tr> <td>VI1220A1</td> <td>VITE AUTOFISETTA NTE 4.2X11 TCS+ MARUTE</td> <td>3</td> <td>PZ</td> </tr> <tr> <td>VM1630A0</td> <td>TAPPO PREMI VETRO INTERNO</td> <td>3</td> <td>PZ</td> </tr> <tr> <td>VM2315A0</td> <td>SUPPORTO SPINGI VETRO INT MM</td> <td>3</td> <td>PZ</td> </tr> </tbody> </table> <table border="1"> <thead> <tr> <th>Codice</th> <th>Descrizione</th> <th>Qtà</th> <th>UM</th> </tr> </thead> <tbody> <tr> <td>VI1220A1</td> <td>VITE AUTOFISETTA NTE 4.2X11 TCS+ MARUTE</td> <td>2</td> <td>PZ</td> </tr> <tr> <td>VM1591A0</td> <td>STAFFA SPINGIVETRO INTERNO XVC1004</td> <td>1</td> <td>PZ</td> </tr> <tr> <td>VM1630A0</td> <td>TAPPO PREMI VETRO INTERNO</td> <td>2</td> <td>PZ</td> </tr> </tbody> </table> <table border="1"> <thead> <tr> <th>Codice</th> <th>Descrizione</th> <th>Qtà</th> <th>UM</th> </tr> </thead> <tbody> <tr> <td>VI1220A1</td> <td>VITE AUTOFISETTA NTE 4.2X11 TCS+ MARUTE</td> <td>2</td> <td>PZ</td> </tr> <tr> <td>VM1590A0</td> <td>STAFFA SPINGIVETRO INTERNO XVC705 XBC80</td> <td>1</td> <td>PZ</td> </tr> <tr> <td>VM1630A0</td> <td>TAPPO PREMI VETRO INTERNO</td> <td>2</td> <td>PZ</td> </tr> </tbody> </table>	Codice	Descrizione	Qtà	UM	VI1220A1	VITE AUTOFISETTA NTE 4.2X11 TCS+ MARUTE	3	PZ	VM1630A0	TAPPO PREMI VETRO INTERNO	3	PZ	VM2315A0	SUPPORTO SPINGI VETRO INT MM	3	PZ	Codice	Descrizione	Qtà	UM	VI1220A1	VITE AUTOFISETTA NTE 4.2X11 TCS+ MARUTE	2	PZ	VM1591A0	STAFFA SPINGIVETRO INTERNO XVC1004	1	PZ	VM1630A0	TAPPO PREMI VETRO INTERNO	2	PZ	Codice	Descrizione	Qtà	UM	VI1220A1	VITE AUTOFISETTA NTE 4.2X11 TCS+ MARUTE	2	PZ	VM1590A0	STAFFA SPINGIVETRO INTERNO XVC705 XBC80	1	PZ	VM1630A0	TAPPO PREMI VETRO INTERNO	2	PZ
Codice	Descrizione	Qtà	UM																																																		
VI1220A1	VITE AUTOFISETTA NTE 4.2X11 TCS+ MARUTE	3	PZ																																																		
VM1630A0	TAPPO PREMI VETRO INTERNO	3	PZ																																																		
VM2315A0	SUPPORTO SPINGI VETRO INT MM	3	PZ																																																		
Codice	Descrizione	Qtà	UM																																																		
VI1220A1	VITE AUTOFISETTA NTE 4.2X11 TCS+ MARUTE	2	PZ																																																		
VM1591A0	STAFFA SPINGIVETRO INTERNO XVC1004	1	PZ																																																		
VM1630A0	TAPPO PREMI VETRO INTERNO	2	PZ																																																		
Codice	Descrizione	Qtà	UM																																																		
VI1220A1	VITE AUTOFISETTA NTE 4.2X11 TCS+ MARUTE	2	PZ																																																		
VM1590A0	STAFFA SPINGIVETRO INTERNO XVC705 XBC80	1	PZ																																																		
VM1630A0	TAPPO PREMI VETRO INTERNO	2	PZ																																																		

COMPONENTE			RICAMBIO										
Codice	Descrizione	Immagine	Codice	Descrizione	Lista componenti								
VM2371A	SPINGIVETRO PORTE DOPPIO VETRO		KVM2371A	KIT SPINGI VETRO PORTE DOPPIO VETRO	<table border="1"> <thead> <tr> <th>Codice</th> <th>Descrizione</th> <th>Qtà</th> <th>UM</th> </tr> </thead> <tbody> <tr> <td>VI1220A1</td> <td>VITE AUTOFILETTA NTE 4.2X11 TCS+ MARUTE</td> <td>3</td> <td>PZ</td> </tr> </tbody> </table>	Codice	Descrizione	Qtà	UM	VI1220A1	VITE AUTOFILETTA NTE 4.2X11 TCS+ MARUTE	3	PZ
					Codice	Descrizione	Qtà	UM					
VI1220A1	VITE AUTOFILETTA NTE 4.2X11 TCS+ MARUTE	3	PZ										
<table border="1"> <tbody> <tr> <td>VM2371A0</td> <td>SPINGIVETRO PORTE DOPPIO VETR</td> <td>3</td> <td>PZ</td> </tr> </tbody> </table>	VM2371A0	SPINGIVETRO PORTE DOPPIO VETR	3	PZ									
VM2371A0	SPINGIVETRO PORTE DOPPIO VETR	3	PZ										
VN1177A	VENTIL ASSIALE 40X40X10MM 12VCC		KVN1179A	KIT VENTIL ASSIALE 40X40X20MM 12VCC	<table border="1"> <thead> <tr> <th>Codice</th> <th>Descrizione</th> <th>Qtà</th> <th>UM</th> </tr> </thead> <tbody> <tr> <td>VN1179A0</td> <td>VENTIL ASSIALE 40X40X20MM 12VCC</td> <td>1</td> <td>PZ</td> </tr> </tbody> </table>	Codice	Descrizione	Qtà	UM	VN1179A0	VENTIL ASSIALE 40X40X20MM 12VCC	1	PZ
					Codice	Descrizione	Qtà	UM					
VN1179A0	VENTIL ASSIALE 40X40X20MM 12VCC	1	PZ										
<table border="1"> <thead> <tr> <th>Codice</th> <th>Descrizione</th> <th>Qtà</th> <th>UM</th> </tr> </thead> <tbody> <tr> <td>VN1177A0</td> <td>VENTIL ASSIALE 40X40X10MM 12VCC</td> <td>1</td> <td>PZ</td> </tr> </tbody> </table>	Codice	Descrizione	Qtà	UM	VN1177A0	VENTIL ASSIALE 40X40X10MM 12VCC	1	PZ					
Codice	Descrizione	Qtà	UM										
VN1177A0	VENTIL ASSIALE 40X40X10MM 12VCC	1	PZ										
VM2316A	SUPPORTO VENTOLA RAFF. CRUSCOTTO		KVM2518A	KIT SUPPORTO VENTOLA RAFF CRUS 20X20 H20	<table border="1"> <thead> <tr> <th>Codice</th> <th>Descrizione</th> <th>Qtà</th> <th>UM</th> </tr> </thead> <tbody> <tr> <td>VM2518A0</td> <td>SUPPORTO VENTOLA RAFF CRUS 20X20 H20</td> <td>1</td> <td>PZ</td> </tr> </tbody> </table>	Codice	Descrizione	Qtà	UM	VM2518A0	SUPPORTO VENTOLA RAFF CRUS 20X20 H20	1	PZ
					Codice	Descrizione	Qtà	UM					
VM2518A0	SUPPORTO VENTOLA RAFF CRUS 20X20 H20	1	PZ										
<table border="1"> <thead> <tr> <th>Codice</th> <th>Descrizione</th> <th>Qtà</th> <th>UM</th> </tr> </thead> <tbody> <tr> <td>VM2316A0</td> <td>SUPPORTO VENTOLA RAFF. CRUSCOTTO</td> <td>1</td> <td>PZ</td> </tr> </tbody> </table>	Codice	Descrizione	Qtà	UM	VM2316A0	SUPPORTO VENTOLA RAFF. CRUSCOTTO	1	PZ					
Codice	Descrizione	Qtà	UM										
VM2316A0	SUPPORTO VENTOLA RAFF. CRUSCOTTO	1	PZ										
VE1030A	CALAMITA D=22,9MM PER MICROPORTA		KVE1030A	KIT MAGNETE MICROPORTA 2 PZ	<table border="1"> <thead> <tr> <th>Codice</th> <th>Descrizione</th> <th>Qtà</th> <th>UM</th> </tr> </thead> <tbody> <tr> <td>VE1030A1</td> <td>CALAMITA D=22,9MM PER MICROPORTA</td> <td>2</td> <td>PZ</td> </tr> </tbody> </table>	Codice	Descrizione	Qtà	UM	VE1030A1	CALAMITA D=22,9MM PER MICROPORTA	2	PZ
					Codice	Descrizione	Qtà	UM					
					VE1030A1	CALAMITA D=22,9MM PER MICROPORTA	2	PZ					
<table border="1"> <thead> <tr> <th>Codice</th> <th>Descrizione</th> <th>Qtà</th> <th>UM</th> </tr> </thead> <tbody> <tr> <td>VE1020A2</td> <td>MICROINTERR UTTORE PORTA MAGNETICO</td> <td>1</td> <td>PZ</td> </tr> </tbody> </table>	Codice	Descrizione	Qtà	UM	VE1020A2	MICROINTERR UTTORE PORTA MAGNETICO	1	PZ					
Codice	Descrizione	Qtà	UM										
VE1020A2	MICROINTERR UTTORE PORTA MAGNETICO	1	PZ										
<table border="1"> <tbody> <tr> <td>VE1030A1</td> <td>CALAMITA D=22,9MM PER MICROPORTA</td> <td>4</td> <td>PZ</td> </tr> </tbody> </table>	VE1030A1	CALAMITA D=22,9MM PER MICROPORTA	4	PZ									
VE1030A1	CALAMITA D=22,9MM PER MICROPORTA	4	PZ										
			KVE1020A	KIT MICROPORTA									

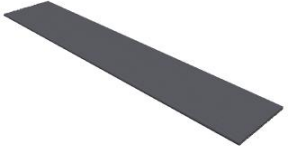
COMPONENTE			RICAMBIO		
<i>Codice</i>	<i>Descrizione</i>	<i>Immagine</i>	<i>Codice</i>	<i>Descrizione</i>	<i>Lista componenti</i>
0H7242A	LAMIERA SOSTEGNO VETRO PORTA XEVC-2011		0H7242A0	LAMIERA SOSTEGNO VETRO PORTA XEVC-2011	
0H7243A	PROFILO INFERIORE PORTA XEVC-2011		0H7243A0	PROFILO INFERIORE PORTA XEVC-2011	
0H7244A	TELAIO INF VETRO INTERNO PORTA XEVC-2011		0H7244A0	TELAIO INF VETRO INTERNO PORTA XEVC-2011	
0H7245A	TELAIO SUP VETRO INTERNO PORTA XEVC-2011		0H7245A0	TELAIO SUP VETRO INTERNO PORTA XEVC-2011	
0H7246A	LAMIERA PORTA GUARNIZIONE XEVC-2011		0H7246A0	LAMIERA PORTA GUARNIZIONE XEVC-2011	

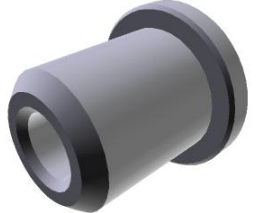
COMPONENTE			RICAMBIO																																		
Codice	Descrizione	Immagine	Codice	Descrizione	Lista componenti																																
GN1553A	GUARNIZIONE PORTA-CARRELLO XEVC-2011-E		KGN1553A	KIT GUARNIZIONE PORTA-CARRELLO MIND.MAPS	<table border="1"> <thead> <tr> <th>Codice</th> <th>Descrizione</th> <th>Qtà</th> <th>UM</th> </tr> </thead> <tbody> <tr> <td>0H7246A0</td> <td>LAMIERA PORTA GUARNIZIONE XEVC-2011</td> <td>1</td> <td>PZ</td> </tr> <tr> <td>GN1341B0</td> <td>GUARNIZIONE PORTA-CARR ELLO H140.3</td> <td>0.750</td> <td>M</td> </tr> <tr> <td>SL1170A1</td> <td>SILICONE ANTRACITE S53 CARTUCCIA 310 ML</td> <td>280</td> <td>ML</td> </tr> <tr> <td>TB2912A0</td> <td>TONDINO GUARNIZIONE PORTA XEVC-2011-E</td> <td>2</td> <td>PZ</td> </tr> <tr> <td>VI1075A0</td> <td>DADO M4 H=4 INOX UNI5587</td> <td>3</td> <td>PZ</td> </tr> <tr> <td>VI1511A0</td> <td>RONDELLA PIANA 4.2X12X1 INOX</td> <td>3</td> <td>PZ</td> </tr> <tr> <td>VI1925A0</td> <td>PRIGIONIERI M4X8 INOX</td> <td>3</td> <td>PZ</td> </tr> </tbody> </table>	Codice	Descrizione	Qtà	UM	0H7246A0	LAMIERA PORTA GUARNIZIONE XEVC-2011	1	PZ	GN1341B0	GUARNIZIONE PORTA-CARR ELLO H140.3	0.750	M	SL1170A1	SILICONE ANTRACITE S53 CARTUCCIA 310 ML	280	ML	TB2912A0	TONDINO GUARNIZIONE PORTA XEVC-2011-E	2	PZ	VI1075A0	DADO M4 H=4 INOX UNI5587	3	PZ	VI1511A0	RONDELLA PIANA 4.2X12X1 INOX	3	PZ	VI1925A0	PRIGIONIERI M4X8 INOX	3	PZ
Codice	Descrizione	Qtà	UM																																		
0H7246A0	LAMIERA PORTA GUARNIZIONE XEVC-2011	1	PZ																																		
GN1341B0	GUARNIZIONE PORTA-CARR ELLO H140.3	0.750	M																																		
SL1170A1	SILICONE ANTRACITE S53 CARTUCCIA 310 ML	280	ML																																		
TB2912A0	TONDINO GUARNIZIONE PORTA XEVC-2011-E	2	PZ																																		
VI1075A0	DADO M4 H=4 INOX UNI5587	3	PZ																																		
VI1511A0	RONDELLA PIANA 4.2X12X1 INOX	3	PZ																																		
VI1925A0	PRIGIONIERI M4X8 INOX	3	PZ																																		
TB2912A	TONDINO GUARNIZIONE PORTA XEVC-2011-E		TB2912A0	TONDINO GUARNIZIONE PORTA XEVC-2011-E																																	
VI1995A	VITE M5X25 TCEI INOX		VI1995A0	VITE M5X25 TCEI INOX																																	
VM2305A	NOTTOLINO FISSAGGIO TAPPI PORTE MM		VM2305A0	NOTTOLINO FISSAGGIO TAPPI PORTE MM																																	



COMPONENTE			RICAMBIO										
Codice	Descrizione	Immagine	Codice	Descrizione	Lista componenti								
VM2275A	BOCCOLA LISCIA		KVM2275A	KIT BOCCOLA LISCIA VM2275A0	<table border="1"> <thead> <tr> <th>Codice</th> <th>Descrizione</th> <th>Qtà</th> <th>UM</th> </tr> </thead> <tbody> <tr> <td>VM2275A0</td> <td>BOCCOLA LISCIA</td> <td>1</td> <td>PZ</td> </tr> </tbody> </table>	Codice	Descrizione	Qtà	UM	VM2275A0	BOCCOLA LISCIA	1	PZ
Codice	Descrizione	Qtà	UM										
VM2275A0	BOCCOLA LISCIA	1	PZ										
VM2264A	TAPPO SUP SX PORTA MM BIG		KVM2264A	KIT TAPPO SUP SX PORTA MM BIG	<table border="1"> <thead> <tr> <th>Codice</th> <th>Descrizione</th> <th>Qtà</th> <th>UM</th> </tr> </thead> <tbody> <tr> <td>VM2264A0</td> <td>TAPPO SUP SX PORTA MM BIG</td> <td>1</td> <td>PZ</td> </tr> </tbody> </table>	Codice	Descrizione	Qtà	UM	VM2264A0	TAPPO SUP SX PORTA MM BIG	1	PZ
Codice	Descrizione	Qtà	UM										
VM2264A0	TAPPO SUP SX PORTA MM BIG	1	PZ										
VM2266A	TAPPO SUP DX PORTA MM BIG		VM2266A0	TAPPO SUP DX PORTA MM BIG									
0H7247A	PROFILO SUPERIORE PORTA XEVC-2011		0H7247A0	PROFILO SUPERIORE PORTA XEVC-2011									
0H7248A	CAMMA PORTA XEVC-2011												





COMPONENTE			RICAMBIO																																																			
Codice	Descrizione	Immagine	Codice	Descrizione	Lista componenti																																																	
VM2274A	BOCCOLA SCANALATA		KVM2274A	KIT BOCCOLA SCANALATA VM2274A0	<table border="1"> <thead> <tr> <th>Codice</th> <th>Descrizione</th> <th>Qtà</th> <th>UM</th> </tr> </thead> <tbody> <tr> <td>VM2274A0</td> <td>BOCCOLA SCANALATA</td> <td>1</td> <td>PZ</td> </tr> </tbody> </table>	Codice	Descrizione	Qtà	UM	VM2274A0	BOCCOLA SCANALATA	1	PZ																																									
			Codice	Descrizione	Qtà	UM																																																
VM2274A0	BOCCOLA SCANALATA	1	PZ																																																			
K0B1126AR	KIT TRAVERSO INF. PORTA BAKERTOP DX	<table border="1"> <thead> <tr> <th>Codice</th> <th>Descrizione</th> <th>Qtà</th> <th>UM</th> </tr> </thead> <tbody> <tr> <td>0B1126A0</td> <td>TRAVERSO INFERIORE PORTA 860 M</td> <td>1</td> <td>PZ</td> </tr> <tr> <td>RC1200A0</td> <td>MOLLA A COMPRESSIO NE DE4 DF0.5 H24</td> <td>2</td> <td>PZ</td> </tr> <tr> <td>VI1220A1</td> <td>VITE AUTOFILETTA NTE 4.2X11 TCS+ MARUTE</td> <td>1</td> <td>PZ</td> </tr> <tr> <td>VI1996A0</td> <td>VITE M5X35 TCEI ZN</td> <td>7</td> <td>PZ</td> </tr> <tr> <td>VM1794A0</td> <td>FASCETTA 250X4.8 PA66 NERA</td> <td>2</td> <td>PZ</td> </tr> <tr> <td>VM2103A0</td> <td>PIASTRINA FERMAFASCE TTA</td> <td>2</td> <td>PZ</td> </tr> <tr> <td>VM2259A1</td> <td>TAPPO INF SX PORTA S6</td> <td>1</td> <td>PZ</td> </tr> <tr> <td>VM2261A1</td> <td>TAPPO INF DX PORTA S6</td> <td>1</td> <td>PZ</td> </tr> <tr> <td>VM2267A0</td> <td>CORSOIO SISTEMA FERMA VETRO INT</td> <td>1</td> <td>PZ</td> </tr> <tr> <td>VM2269A0</td> <td>TAPPO SISTEMA FERMA VETRO INT</td> <td>1</td> <td>PZ</td> </tr> <tr> <td>VM2274A0</td> <td>BOCCOLA SCANALATA</td> <td>1</td> <td>PZ</td> </tr> <tr> <td>VM2305A0</td> <td>NOTTOLINO FISSAGGIO TAPPI PORTE MM</td> <td>7</td> <td>PZ</td> </tr> </tbody> </table>	Codice	Descrizione	Qtà	UM	0B1126A0	TRAVERSO INFERIORE PORTA 860 M	1	PZ	RC1200A0	MOLLA A COMPRESSIO NE DE4 DF0.5 H24	2	PZ	VI1220A1	VITE AUTOFILETTA NTE 4.2X11 TCS+ MARUTE	1	PZ	VI1996A0	VITE M5X35 TCEI ZN	7	PZ	VM1794A0	FASCETTA 250X4.8 PA66 NERA	2	PZ	VM2103A0	PIASTRINA FERMAFASCE TTA	2	PZ	VM2259A1	TAPPO INF SX PORTA S6	1	PZ	VM2261A1	TAPPO INF DX PORTA S6	1	PZ	VM2267A0	CORSOIO SISTEMA FERMA VETRO INT	1	PZ	VM2269A0	TAPPO SISTEMA FERMA VETRO INT	1	PZ	VM2274A0	BOCCOLA SCANALATA	1	PZ	VM2305A0	NOTTOLINO FISSAGGIO TAPPI PORTE MM	7	PZ
Codice	Descrizione	Qtà	UM																																																			
0B1126A0	TRAVERSO INFERIORE PORTA 860 M	1	PZ																																																			
RC1200A0	MOLLA A COMPRESSIO NE DE4 DF0.5 H24	2	PZ																																																			
VI1220A1	VITE AUTOFILETTA NTE 4.2X11 TCS+ MARUTE	1	PZ																																																			
VI1996A0	VITE M5X35 TCEI ZN	7	PZ																																																			
VM1794A0	FASCETTA 250X4.8 PA66 NERA	2	PZ																																																			
VM2103A0	PIASTRINA FERMAFASCE TTA	2	PZ																																																			
VM2259A1	TAPPO INF SX PORTA S6	1	PZ																																																			
VM2261A1	TAPPO INF DX PORTA S6	1	PZ																																																			
VM2267A0	CORSOIO SISTEMA FERMA VETRO INT	1	PZ																																																			
VM2269A0	TAPPO SISTEMA FERMA VETRO INT	1	PZ																																																			
VM2274A0	BOCCOLA SCANALATA	1	PZ																																																			
VM2305A0	NOTTOLINO FISSAGGIO TAPPI PORTE MM	7	PZ																																																			
K0B1126AL	KIT TRAVERSO INF PORTA BAKERTOP SX	<table border="1"> <thead> <tr> <th>Codice</th> <th>Descrizione</th> <th>Qtà</th> <th>UM</th> </tr> </thead> <tbody> <tr> <td>0B1126A0</td> <td>TRAVERSO INFERIORE PORTA 860 M</td> <td>1</td> <td>PZ</td> </tr> <tr> <td>RC1200A0</td> <td>MOLLA A COMPRESSIO NE DE4 DF0.5 H24</td> <td>2</td> <td>PZ</td> </tr> <tr> <td>VI1220A1</td> <td>VITE AUTOFILETTA NTE 4.2X11 TCS+ MARUTE</td> <td>1</td> <td>PZ</td> </tr> </tbody> </table>	Codice	Descrizione	Qtà	UM	0B1126A0	TRAVERSO INFERIORE PORTA 860 M	1	PZ	RC1200A0	MOLLA A COMPRESSIO NE DE4 DF0.5 H24	2	PZ	VI1220A1	VITE AUTOFILETTA NTE 4.2X11 TCS+ MARUTE	1	PZ																																				
Codice	Descrizione	Qtà	UM																																																			
0B1126A0	TRAVERSO INFERIORE PORTA 860 M	1	PZ																																																			
RC1200A0	MOLLA A COMPRESSIO NE DE4 DF0.5 H24	2	PZ																																																			
VI1220A1	VITE AUTOFILETTA NTE 4.2X11 TCS+ MARUTE	1	PZ																																																			



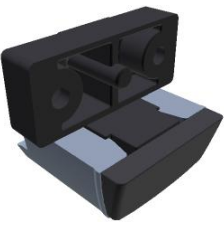

COMPONENTE			RICAMBIO																																										
Codice	Descrizione	Immagine	Codice	Descrizione	Lista componenti																																								
VM2274A	BOCCOLA SCANALATA		K0B1126AL	KIT TRAVERSO INF PORTA BAKERTOP SX	<table border="1"> <thead> <tr> <th>Codice</th> <th>Descrizione</th> <th>Qtà</th> <th>UM</th> </tr> </thead> <tbody> <tr> <td>VI1996A0</td> <td>VITE M5X35 TCEI ZN</td> <td>7</td> <td>PZ</td> </tr> <tr> <td>VM1794A0</td> <td>FASCETTA 250X4.8 PA66 NERA</td> <td>2</td> <td>PZ</td> </tr> <tr> <td>VM2103A0</td> <td>PIASTRINA FERMAFASCE TTA</td> <td>2</td> <td>PZ</td> </tr> <tr> <td>VM2267A0</td> <td>CORSOIO SISTEMA FERMA VETRO INT</td> <td>1</td> <td>PZ</td> </tr> <tr> <td>VM2269A0</td> <td>TAPPO SISTEMA FERMA VETRO INT</td> <td>1</td> <td>PZ</td> </tr> <tr> <td>VM2274A0</td> <td>BOCCOLA SCANALATA</td> <td>1</td> <td>PZ</td> </tr> <tr> <td>VM2305A0</td> <td>NOTTOLINO FISSAGGIO TAPPI PORTE MM</td> <td>7</td> <td>PZ</td> </tr> <tr> <td>VM2384A0</td> <td>TAPPO INF DX PORTA MM LEFT</td> <td>1</td> <td>PZ</td> </tr> <tr> <td>VM2386A1</td> <td>TAPPO INF SX PORTA MM LEFT</td> <td>1</td> <td>PZ</td> </tr> </tbody> </table>	Codice	Descrizione	Qtà	UM	VI1996A0	VITE M5X35 TCEI ZN	7	PZ	VM1794A0	FASCETTA 250X4.8 PA66 NERA	2	PZ	VM2103A0	PIASTRINA FERMAFASCE TTA	2	PZ	VM2267A0	CORSOIO SISTEMA FERMA VETRO INT	1	PZ	VM2269A0	TAPPO SISTEMA FERMA VETRO INT	1	PZ	VM2274A0	BOCCOLA SCANALATA	1	PZ	VM2305A0	NOTTOLINO FISSAGGIO TAPPI PORTE MM	7	PZ	VM2384A0	TAPPO INF DX PORTA MM LEFT	1	PZ	VM2386A1	TAPPO INF SX PORTA MM LEFT	1	PZ
			Codice		Descrizione	Qtà	UM																																						
VI1996A0	VITE M5X35 TCEI ZN	7	PZ																																										
VM1794A0	FASCETTA 250X4.8 PA66 NERA	2	PZ																																										
VM2103A0	PIASTRINA FERMAFASCE TTA	2	PZ																																										
VM2267A0	CORSOIO SISTEMA FERMA VETRO INT	1	PZ																																										
VM2269A0	TAPPO SISTEMA FERMA VETRO INT	1	PZ																																										
VM2274A0	BOCCOLA SCANALATA	1	PZ																																										
VM2305A0	NOTTOLINO FISSAGGIO TAPPI PORTE MM	7	PZ																																										
VM2384A0	TAPPO INF DX PORTA MM LEFT	1	PZ																																										
VM2386A1	TAPPO INF SX PORTA MM LEFT	1	PZ																																										
K0B1122AR	KIT TRAVERSO INF. PORTA CHEFTOP D	<table border="1"> <thead> <tr> <th>Codice</th> <th>Descrizione</th> <th>Qtà</th> <th>UM</th> </tr> </thead> <tbody> <tr> <td>0B1122A0</td> <td>TRAVERSO INFERIORE PORTA 750 M</td> <td>1</td> <td>PZ</td> </tr> <tr> <td>RC1200A0</td> <td>MOLLA A COMPRESSIO NE DE4 DF0.5 H24</td> <td>2</td> <td>PZ</td> </tr> <tr> <td>VI1220A1</td> <td>VITE AUTOFILETTA NTE 4.2X11 TCS+ MARUTE</td> <td>1</td> <td>PZ</td> </tr> <tr> <td>VI1996A0</td> <td>VITE M5X35 TCEI ZN</td> <td>7</td> <td>PZ</td> </tr> <tr> <td>VM1794A0</td> <td>FASCETTA 250X4.8 PA66 NERA</td> <td>2</td> <td>PZ</td> </tr> <tr> <td>VM2103A0</td> <td>PIASTRINA FERMAFASCE TTA</td> <td>2</td> <td>PZ</td> </tr> <tr> <td>VM2259A1</td> <td>TAPPO INF SX PORTA S6</td> <td>1</td> <td>PZ</td> </tr> <tr> <td>VM2261A1</td> <td>TAPPO INF DX PORTA S6</td> <td>1</td> <td>PZ</td> </tr> </tbody> </table>	Codice		Descrizione	Qtà	UM	0B1122A0	TRAVERSO INFERIORE PORTA 750 M	1	PZ	RC1200A0	MOLLA A COMPRESSIO NE DE4 DF0.5 H24	2	PZ	VI1220A1	VITE AUTOFILETTA NTE 4.2X11 TCS+ MARUTE	1	PZ	VI1996A0	VITE M5X35 TCEI ZN	7	PZ	VM1794A0	FASCETTA 250X4.8 PA66 NERA	2	PZ	VM2103A0	PIASTRINA FERMAFASCE TTA	2	PZ	VM2259A1	TAPPO INF SX PORTA S6	1	PZ	VM2261A1	TAPPO INF DX PORTA S6	1	PZ						
Codice		Descrizione	Qtà		UM																																								
0B1122A0		TRAVERSO INFERIORE PORTA 750 M	1	PZ																																									
RC1200A0		MOLLA A COMPRESSIO NE DE4 DF0.5 H24	2	PZ																																									
VI1220A1		VITE AUTOFILETTA NTE 4.2X11 TCS+ MARUTE	1	PZ																																									
VI1996A0		VITE M5X35 TCEI ZN	7	PZ																																									
VM1794A0		FASCETTA 250X4.8 PA66 NERA	2	PZ																																									
VM2103A0		PIASTRINA FERMAFASCE TTA	2	PZ																																									
VM2259A1		TAPPO INF SX PORTA S6	1	PZ																																									
VM2261A1		TAPPO INF DX PORTA S6	1	PZ																																									

COMPONENTE			RICAMBIO																																																			
Codice	Descrizione	Immagine	Codice	Descrizione	Lista componenti																																																	
VM2274A	BOCCOLA SCANALATA		K0B1122AR	KIT TRAVERSO INF. PORTA CHEFTOP D	<table border="1"> <thead> <tr> <th>Codice</th> <th>Descrizione</th> <th>Qtà</th> <th>UM</th> </tr> </thead> <tbody> <tr> <td>VM2267A0</td> <td>CORSOIO SISTEMA FERMA VETRO INT</td> <td>1</td> <td>PZ</td> </tr> <tr> <td>VM2269A0</td> <td>TAPPO SISTEMA FERMA VETRO INT</td> <td>1</td> <td>PZ</td> </tr> <tr> <td>VM2274A0</td> <td>BOCCOLA SCANALATA</td> <td>1</td> <td>PZ</td> </tr> <tr> <td>VM2305A0</td> <td>NOTTOLINO FISSAGGIO TAPPI PORTE MM</td> <td>7</td> <td>PZ</td> </tr> </tbody> </table>	Codice	Descrizione	Qtà	UM	VM2267A0	CORSOIO SISTEMA FERMA VETRO INT	1	PZ	VM2269A0	TAPPO SISTEMA FERMA VETRO INT	1	PZ	VM2274A0	BOCCOLA SCANALATA	1	PZ	VM2305A0	NOTTOLINO FISSAGGIO TAPPI PORTE MM	7	PZ																													
			Codice	Descrizione	Qtà	UM																																																
VM2267A0	CORSOIO SISTEMA FERMA VETRO INT	1	PZ																																																			
VM2269A0	TAPPO SISTEMA FERMA VETRO INT	1	PZ																																																			
VM2274A0	BOCCOLA SCANALATA	1	PZ																																																			
VM2305A0	NOTTOLINO FISSAGGIO TAPPI PORTE MM	7	PZ																																																			
K0B1122AL	KIT TRAVERSO INF. PORTA CHEFTOP MM SX	<table border="1"> <thead> <tr> <th>Codice</th> <th>Descrizione</th> <th>Qtà</th> <th>UM</th> </tr> </thead> <tbody> <tr> <td>0B1122A0</td> <td>TRAVERSO INFERIORE PORTA 750 M</td> <td>1</td> <td>PZ</td> </tr> <tr> <td>RC1200A0</td> <td>MOLLA A COMPRESSIO NE DE4 DF0.5 H24</td> <td>2</td> <td>PZ</td> </tr> <tr> <td>VI1220A1</td> <td>VITE AUTOFILETTA NTE 4.2X11 TCS+ MARUTE</td> <td>1</td> <td>PZ</td> </tr> <tr> <td>VI1996A0</td> <td>VITE M5X35 TCEI ZN</td> <td>7</td> <td>PZ</td> </tr> <tr> <td>VM1794A0</td> <td>FASCETTA 250X4.8 PA66 NERA</td> <td>2</td> <td>PZ</td> </tr> <tr> <td>VM2103A0</td> <td>PIASTRINA FERMAFASCE TTA</td> <td>2</td> <td>PZ</td> </tr> <tr> <td>VM2267A0</td> <td>CORSOIO SISTEMA FERMA VETRO INT</td> <td>1</td> <td>PZ</td> </tr> <tr> <td>VM2269A0</td> <td>TAPPO SISTEMA FERMA VETRO INT</td> <td>1</td> <td>PZ</td> </tr> <tr> <td>VM2274A0</td> <td>BOCCOLA SCANALATA</td> <td>1</td> <td>PZ</td> </tr> <tr> <td>VM2305A0</td> <td>NOTTOLINO FISSAGGIO TAPPI PORTE MM</td> <td>7</td> <td>PZ</td> </tr> <tr> <td>VM2384A0</td> <td>TAPPO INF DX PORTA MM LEFT</td> <td>1</td> <td>PZ</td> </tr> <tr> <td>VM2386A1</td> <td>TAPPO INF SX PORTA MM LEFT</td> <td>1</td> <td>PZ</td> </tr> </tbody> </table>	Codice	Descrizione	Qtà	UM	0B1122A0	TRAVERSO INFERIORE PORTA 750 M	1	PZ	RC1200A0	MOLLA A COMPRESSIO NE DE4 DF0.5 H24	2	PZ	VI1220A1	VITE AUTOFILETTA NTE 4.2X11 TCS+ MARUTE	1	PZ	VI1996A0	VITE M5X35 TCEI ZN	7	PZ	VM1794A0	FASCETTA 250X4.8 PA66 NERA	2	PZ	VM2103A0	PIASTRINA FERMAFASCE TTA	2	PZ	VM2267A0	CORSOIO SISTEMA FERMA VETRO INT	1	PZ	VM2269A0	TAPPO SISTEMA FERMA VETRO INT	1	PZ	VM2274A0	BOCCOLA SCANALATA	1	PZ	VM2305A0	NOTTOLINO FISSAGGIO TAPPI PORTE MM	7	PZ	VM2384A0	TAPPO INF DX PORTA MM LEFT	1	PZ	VM2386A1	TAPPO INF SX PORTA MM LEFT	1	PZ
Codice	Descrizione	Qtà	UM																																																			
0B1122A0	TRAVERSO INFERIORE PORTA 750 M	1	PZ																																																			
RC1200A0	MOLLA A COMPRESSIO NE DE4 DF0.5 H24	2	PZ																																																			
VI1220A1	VITE AUTOFILETTA NTE 4.2X11 TCS+ MARUTE	1	PZ																																																			
VI1996A0	VITE M5X35 TCEI ZN	7	PZ																																																			
VM1794A0	FASCETTA 250X4.8 PA66 NERA	2	PZ																																																			
VM2103A0	PIASTRINA FERMAFASCE TTA	2	PZ																																																			
VM2267A0	CORSOIO SISTEMA FERMA VETRO INT	1	PZ																																																			
VM2269A0	TAPPO SISTEMA FERMA VETRO INT	1	PZ																																																			
VM2274A0	BOCCOLA SCANALATA	1	PZ																																																			
VM2305A0	NOTTOLINO FISSAGGIO TAPPI PORTE MM	7	PZ																																																			
VM2384A0	TAPPO INF DX PORTA MM LEFT	1	PZ																																																			
VM2386A1	TAPPO INF SX PORTA MM LEFT	1	PZ																																																			

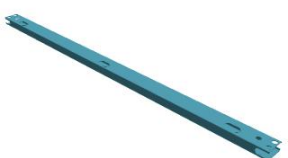
COMPONENTE			RICAMBIO																						
Codice	Descrizione	Immagine	Codice	Descrizione	Lista componenti																				
VM2263A	TAPPO INF SX PORTA MM BIG		KVM2263A	KIT TAPPO INF SX PORTA MM BIG	<table border="1"> <thead> <tr> <th>Codice</th> <th>Descrizione</th> <th>Qtà</th> <th>UM</th> </tr> </thead> <tbody> <tr> <td>VM2263A0</td> <td>TAPPO INF SX PORTA MM BI</td> <td>1</td> <td>PZ</td> </tr> </tbody> </table>	Codice	Descrizione	Qtà	UM	VM2263A0	TAPPO INF SX PORTA MM BI	1	PZ												
Codice	Descrizione	Qtà	UM																						
VM2263A0	TAPPO INF SX PORTA MM BI	1	PZ																						
VM2268A	TAPPO COPRI CALAMITA PORTA		KVM2268A	KIT TAPPO COPRI CALAMITA PORTA	<table border="1"> <thead> <tr> <th>Codice</th> <th>Descrizione</th> <th>Qtà</th> <th>UM</th> </tr> </thead> <tbody> <tr> <td>VM2268A0</td> <td>TAPPO COPRI CALAMITA PORTA</td> <td>1</td> <td>PZ</td> </tr> </tbody> </table>	Codice	Descrizione	Qtà	UM	VM2268A0	TAPPO COPRI CALAMITA PORTA	1	PZ												
Codice	Descrizione	Qtà	UM																						
VM2268A0	TAPPO COPRI CALAMITA PORTA	1	PZ																						
VM2265A	TAPPO INF DX PORTA MM BIG		KVM2265A	KIT TAPPO INF DX PORTA MM BIG	<table border="1"> <thead> <tr> <th>Codice</th> <th>Descrizione</th> <th>Qtà</th> <th>UM</th> </tr> </thead> <tbody> <tr> <td>VM2265A0</td> <td>TAPPO INF DX PORTA MM BI</td> <td>1</td> <td>PZ</td> </tr> </tbody> </table>	Codice	Descrizione	Qtà	UM	VM2265A0	TAPPO INF DX PORTA MM BI	1	PZ												
Codice	Descrizione	Qtà	UM																						
VM2265A0	TAPPO INF DX PORTA MM BI	1	PZ																						
LP1029A	ESTRUSO ILLUMINAZIONE NO LED MM L1199		KLP1029A	KIT ESTRUSO ILLUMINAZIONE NO LED MM L119	<table border="1"> <thead> <tr> <th>Codice</th> <th>Descrizione</th> <th>Qtà</th> <th>UM</th> </tr> </thead> <tbody> <tr> <td>IP1385A1</td> <td>IMB POL ANGOLARE 110X80X2000 D30</td> <td>2.540</td> <td>M</td> </tr> <tr> <td>LP1029A0</td> <td>ESTRUSO ILLUMINAZION E NO LED MM L1199</td> <td>1</td> <td>PZ</td> </tr> <tr> <td>VM1058A1</td> <td>FILM TERMORETRA IBILE H410</td> <td>2.540</td> <td>M</td> </tr> <tr> <td>VM1059A1</td> <td>FILM TERMORETRA IBILE H800</td> <td>2.540</td> <td>M</td> </tr> </tbody> </table>	Codice	Descrizione	Qtà	UM	IP1385A1	IMB POL ANGOLARE 110X80X2000 D30	2.540	M	LP1029A0	ESTRUSO ILLUMINAZION E NO LED MM L1199	1	PZ	VM1058A1	FILM TERMORETRA IBILE H410	2.540	M	VM1059A1	FILM TERMORETRA IBILE H800	2.540	M
Codice	Descrizione	Qtà	UM																						
IP1385A1	IMB POL ANGOLARE 110X80X2000 D30	2.540	M																						
LP1029A0	ESTRUSO ILLUMINAZION E NO LED MM L1199	1	PZ																						
VM1058A1	FILM TERMORETRA IBILE H410	2.540	M																						
VM1059A1	FILM TERMORETRA IBILE H800	2.540	M																						

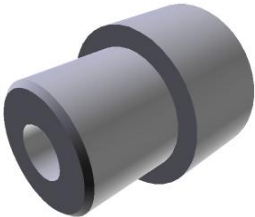
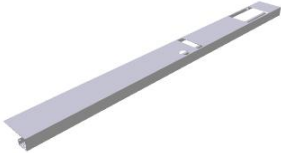
COMPONENTE			RICAMBIO																						
Codice	Descrizione	Immagine	Codice	Descrizione	Lista componenti																				
VM2339A			VM2339A0																						
LP1023A	BARRA ILLUMINAZIONE LED MM L1000 E1199		KLP1023A	KIT BARRA ILL.LED MM L800 E1199	<table border="1"> <thead> <tr> <th>Codice</th> <th>Descrizione</th> <th>Qtà</th> <th>UM</th> </tr> </thead> <tbody> <tr> <td>IP1385A1</td> <td>IMB POL ANGOLARE 110X80X2000 D30</td> <td>2.540</td> <td>M</td> </tr> <tr> <td>LP1023A0</td> <td>BARRA ILLUMINAZION E LED MM L1000 E1199</td> <td>1</td> <td>PZ</td> </tr> <tr> <td>VM1058A1</td> <td>FILM TERMORETRA IBILE H410</td> <td>2.540</td> <td>M</td> </tr> <tr> <td>VM1059A1</td> <td>FILM TERMORETRA IBILE H800</td> <td>2.540</td> <td>M</td> </tr> </tbody> </table>	Codice	Descrizione	Qtà	UM	IP1385A1	IMB POL ANGOLARE 110X80X2000 D30	2.540	M	LP1023A0	BARRA ILLUMINAZION E LED MM L1000 E1199	1	PZ	VM1058A1	FILM TERMORETRA IBILE H410	2.540	M	VM1059A1	FILM TERMORETRA IBILE H800	2.540	M
Codice	Descrizione	Qtà	UM																						
IP1385A1	IMB POL ANGOLARE 110X80X2000 D30	2.540	M																						
LP1023A0	BARRA ILLUMINAZION E LED MM L1000 E1199	1	PZ																						
VM1058A1	FILM TERMORETRA IBILE H410	2.540	M																						
VM1059A1	FILM TERMORETRA IBILE H800	2.540	M																						
VM2339A			VM2339A0																						
VM2355A	ASM CHIUSURA VETRO INTERNO XEVC-2011		KVM2355A	KIT CHIUSURA VETRO INT XEVC-2011 2 PZ	<table border="1"> <thead> <tr> <th>Codice</th> <th>Descrizione</th> <th>Qtà</th> <th>UM</th> </tr> </thead> <tbody> <tr> <td>VI1220A1</td> <td>VITE AUTOFILETTA NTE 4.2X11 TCS+ MARUTE</td> <td>4</td> <td>PZ</td> </tr> <tr> <td>VM2355A0</td> <td>ASM CHIUSURA VETRO INTERNO XEVC-2011</td> <td>2</td> <td>PZ</td> </tr> </tbody> </table>	Codice	Descrizione	Qtà	UM	VI1220A1	VITE AUTOFILETTA NTE 4.2X11 TCS+ MARUTE	4	PZ	VM2355A0	ASM CHIUSURA VETRO INTERNO XEVC-2011	2	PZ								
Codice	Descrizione	Qtà	UM																						
VI1220A1	VITE AUTOFILETTA NTE 4.2X11 TCS+ MARUTE	4	PZ																						
VM2355A0	ASM CHIUSURA VETRO INTERNO XEVC-2011	2	PZ																						

COMPONENTE			RICAMBIO																						
Codice	Descrizione	Immagine	Codice	Descrizione	Lista componenti																				
TB2911A	TRAVERSO PORTA XEVC-2011-E																								
VM2410A	PIASTRINA FERMA ESTRUSO BARRA LED		KVM2410A	KIT PIASTRINA FERMA ESTRUSO BARRA LED 2P	<table border="1"> <thead> <tr> <th>Codice</th> <th>Descrizione</th> <th>Qtà</th> <th>UM</th> </tr> </thead> <tbody> <tr> <td>0B1190A0</td> <td>PIASTRINA FERMA ESTRUSO BARRA LED</td> <td>2</td> <td>PZ</td> </tr> <tr> <td>VM2410A0</td> <td>PIASTRINA FERMA ESTRUSO BARRA LED</td> <td>2</td> <td>PZ</td> </tr> </tbody> </table>	Codice	Descrizione	Qtà	UM	0B1190A0	PIASTRINA FERMA ESTRUSO BARRA LED	2	PZ	VM2410A0	PIASTRINA FERMA ESTRUSO BARRA LED	2	PZ								
Codice	Descrizione	Qtà	UM																						
0B1190A0	PIASTRINA FERMA ESTRUSO BARRA LED	2	PZ																						
VM2410A0	PIASTRINA FERMA ESTRUSO BARRA LED	2	PZ																						
PE2046A	ASSIEME SUPPORTO USB-RESET MM		KPE2046A	KIT ASSIEME SUPPORTO USB-RESET MM	<table border="1"> <thead> <tr> <th>Codice</th> <th>Descrizione</th> <th>Qtà</th> <th>UM</th> </tr> </thead> <tbody> <tr> <td>PE2046A0</td> <td>ASSIEME SUPPORTO USB-RESET M</td> <td>1</td> <td>PZ</td> </tr> <tr> <td>PE2046A1</td> <td>ASSIEME SUPPORTO USB-RESET M</td> <td>1</td> <td>PZ</td> </tr> <tr> <td>VI1220A1</td> <td>VITE AUTOFILETTA NTE 4.2X11 TCS+ MARUTE</td> <td>2</td> <td>PZ</td> </tr> <tr> <td>VM2147A0</td> <td>SPUGNA ESD ROSA LISCIA 410X343X15 M</td> <td>0.250</td> <td>PZ</td> </tr> </tbody> </table>	Codice	Descrizione	Qtà	UM	PE2046A0	ASSIEME SUPPORTO USB-RESET M	1	PZ	PE2046A1	ASSIEME SUPPORTO USB-RESET M	1	PZ	VI1220A1	VITE AUTOFILETTA NTE 4.2X11 TCS+ MARUTE	2	PZ	VM2147A0	SPUGNA ESD ROSA LISCIA 410X343X15 M	0.250	PZ
Codice	Descrizione	Qtà	UM																						
PE2046A0	ASSIEME SUPPORTO USB-RESET M	1	PZ																						
PE2046A1	ASSIEME SUPPORTO USB-RESET M	1	PZ																						
VI1220A1	VITE AUTOFILETTA NTE 4.2X11 TCS+ MARUTE	2	PZ																						
VM2147A0	SPUGNA ESD ROSA LISCIA 410X343X15 M	0.250	PZ																						
TB3204A	ASM TRAVERSO SUP PORTA XEVC-2011-E		TB3204A0	ASM TRAVERSO SUP PORTA XEVC-2011-E																					
TB3203A	TRAVERSO SUP PORTA XEVC-2011-E																								

COMPONENTE			RICAMBIO																										
Codice	Descrizione	Immagine	Codice	Descrizione	Lista componenti																								
VM2437A	PERNO RIALZO VETRO INTERNO BI																												
0H7778A	COLONNINA ESTERNA DX PORTA XEVC-2011		0H7778A0	COLONNINA ESTERNA DX PORTA XEVC-2011																									
0H7240A	COLONNINA INTERNA DX PORTA XEVC-2011																												
0H7241A	COLONNINA INTERNA SX PORTA XEVC-2011																												
PE2042A	ASSIEME CRUSCOTTO COMANDI MM ONE		KPE2042A	KIT CONTROLLO COMANDI MIND.MAPS ONE	<table border="1"> <thead> <tr> <th>Codice</th> <th>Descrizione</th> <th>Qtà</th> <th>UM</th> </tr> </thead> <tbody> <tr> <td>PE2042A0</td> <td>ASSIEME CRUSCOTTO COMANDI MM ONE</td> <td>1</td> <td>PZ</td> </tr> <tr> <td>PE2042A1</td> <td>ASSIEME CRUSCOTTO COMANDI MM ONE</td> <td>1</td> <td>PZ</td> </tr> <tr> <td>PE2042A2</td> <td>ASSIEME CRUSCOTTO COMANDI MM ONE</td> <td>1</td> <td>PZ</td> </tr> <tr> <td>VI2000A0</td> <td>VITE M4X22 TCB+ INOX</td> <td>4</td> <td>PZ</td> </tr> <tr> <td>VM2147A0</td> <td>SPUGNA ESD ROSA LISCIA 410X343X15 M</td> <td>1</td> <td>PZ</td> </tr> </tbody> </table>	Codice	Descrizione	Qtà	UM	PE2042A0	ASSIEME CRUSCOTTO COMANDI MM ONE	1	PZ	PE2042A1	ASSIEME CRUSCOTTO COMANDI MM ONE	1	PZ	PE2042A2	ASSIEME CRUSCOTTO COMANDI MM ONE	1	PZ	VI2000A0	VITE M4X22 TCB+ INOX	4	PZ	VM2147A0	SPUGNA ESD ROSA LISCIA 410X343X15 M	1	PZ
Codice	Descrizione	Qtà	UM																										
PE2042A0	ASSIEME CRUSCOTTO COMANDI MM ONE	1	PZ																										
PE2042A1	ASSIEME CRUSCOTTO COMANDI MM ONE	1	PZ																										
PE2042A2	ASSIEME CRUSCOTTO COMANDI MM ONE	1	PZ																										
VI2000A0	VITE M4X22 TCB+ INOX	4	PZ																										
VM2147A0	SPUGNA ESD ROSA LISCIA 410X343X15 M	1	PZ																										

ASM1800A/0.D02 - Copertura esterna

FRONTE

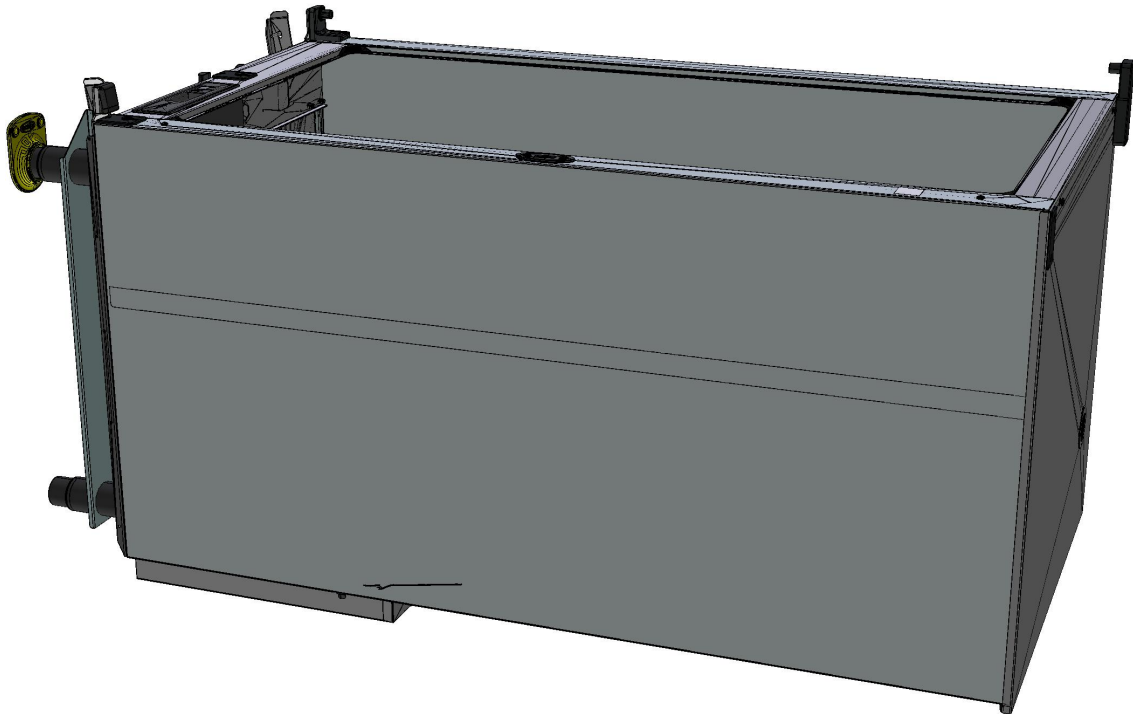

ASM1800A/0.D02 - Copertura esterna

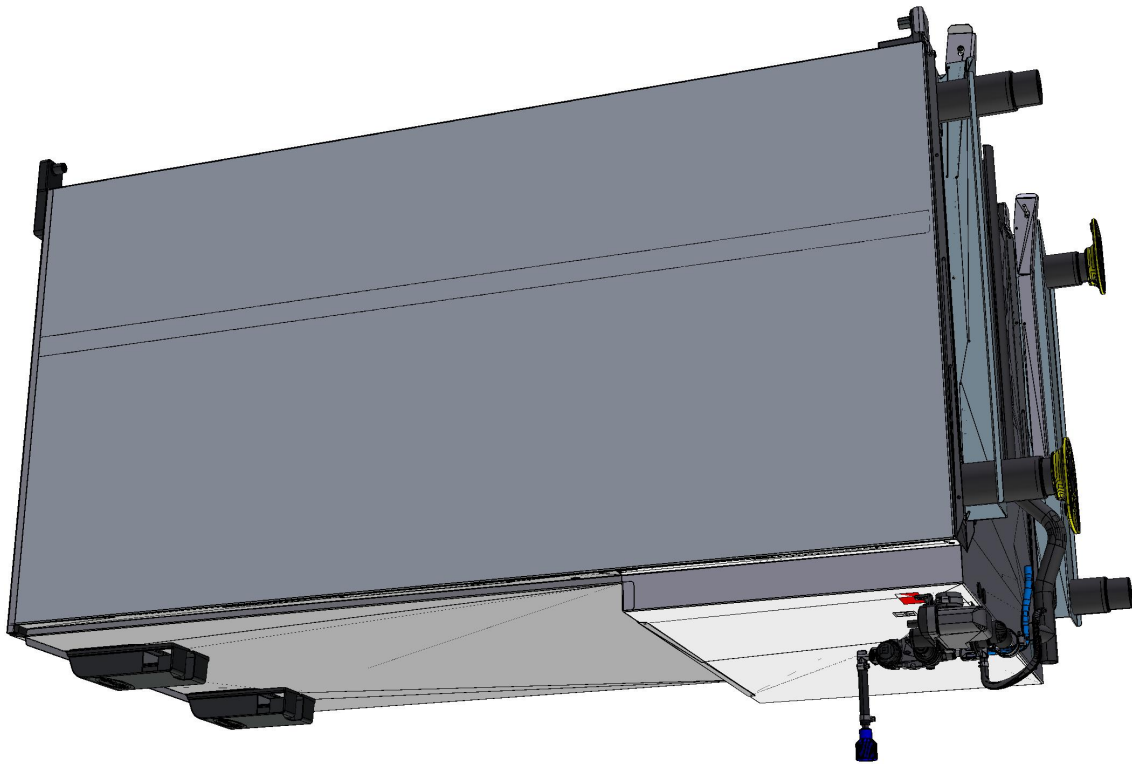

RETRO

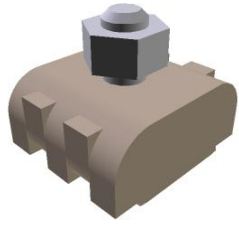
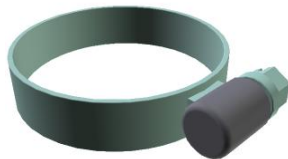



COMPONENTE			RICAMBIO																																																										
Codice	Descrizione	Immagine	Codice	Descrizione	Lista componenti																																																								
VM1750A	MORSETTO A PETTINE		KVM1750A	KIT MORSETTIERA A PETTINE	<table border="1"> <thead> <tr> <th>Codice</th> <th>Descrizione</th> <th>Qtà</th> <th>UM</th> </tr> </thead> <tbody> <tr> <td>VM1750A0</td> <td>MORSETTO A PETTINE</td> <td>1</td> <td>PZ</td> </tr> </tbody> </table>	Codice	Descrizione	Qtà	UM	VM1750A0	MORSETTO A PETTINE	1	PZ																																																
Codice	Descrizione	Qtà	UM																																																										
VM1750A0	MORSETTO A PETTINE	1	PZ																																																										
RC1378A	FASCETTA STRINGI TUBO ZINCATA		KVE1135A	KIT RICAMBIO VENTURI FORNI SERIE 5/E	<table border="1"> <thead> <tr> <th>Codice</th> <th>Descrizione</th> <th>Qtà</th> <th>UM</th> </tr> </thead> <tbody> <tr> <td>GN1310A0</td> <td>GUARNIZIONE PIATTELLO VENTURI SILICONE</td> <td>1</td> <td>PZ</td> </tr> <tr> <td>GN1556A0</td> <td>GUARNIZIONE VENTURI MM</td> <td>1</td> <td>PZ</td> </tr> <tr> <td>RC1378A0</td> <td>FASCETTA STRINGI TUBO ZINCATA</td> <td>2</td> <td>PZ</td> </tr> <tr> <td>TB1520A0</td> <td>TUBO D.INT=30 SP=4 GOMMA EPDM NERO</td> <td>0.050</td> <td>M</td> </tr> <tr> <td>VE1135A0</td> <td>ATTUATORE VENTURI 220V 50/60 HZ SERIE 2</td> <td>1</td> <td>PZ</td> </tr> <tr> <td>VI1032A0</td> <td>VITE M4X16 TCB+ INOX</td> <td>1</td> <td>PZ</td> </tr> <tr> <td>VI1511A0</td> <td>RONDELLA PIANA 4.2X12X1 INOX</td> <td>2</td> <td>PZ</td> </tr> <tr> <td>VI1850A0</td> <td>VITE M4X6 TCB+ NICHELATA</td> <td>2</td> <td>PZ</td> </tr> <tr> <td>VI1865A0</td> <td>VITE AUTOFIL. 5X10 TCB+</td> <td>3</td> <td>PZ</td> </tr> <tr> <td>VM1565B0</td> <td>PORTA BOBINA INFERIORE VENTURI CT B</td> <td>1</td> <td>PZ</td> </tr> <tr> <td>VM1566A0</td> <td>PORTA BOBINA SUPERIORE VENTURI</td> <td>1</td> <td>PZ</td> </tr> <tr> <td>VM1567A0</td> <td>BOCCOLA INFERIORE VENTURI</td> <td>1</td> <td>PZ</td> </tr> <tr> <td>VM1568A0</td> <td>DISTANZIALE PIATTELLO VENTURI</td> <td>1</td> <td>PZ</td> </tr> </tbody> </table>	Codice	Descrizione	Qtà	UM	GN1310A0	GUARNIZIONE PIATTELLO VENTURI SILICONE	1	PZ	GN1556A0	GUARNIZIONE VENTURI MM	1	PZ	RC1378A0	FASCETTA STRINGI TUBO ZINCATA	2	PZ	TB1520A0	TUBO D.INT=30 SP=4 GOMMA EPDM NERO	0.050	M	VE1135A0	ATTUATORE VENTURI 220V 50/60 HZ SERIE 2	1	PZ	VI1032A0	VITE M4X16 TCB+ INOX	1	PZ	VI1511A0	RONDELLA PIANA 4.2X12X1 INOX	2	PZ	VI1850A0	VITE M4X6 TCB+ NICHELATA	2	PZ	VI1865A0	VITE AUTOFIL. 5X10 TCB+	3	PZ	VM1565B0	PORTA BOBINA INFERIORE VENTURI CT B	1	PZ	VM1566A0	PORTA BOBINA SUPERIORE VENTURI	1	PZ	VM1567A0	BOCCOLA INFERIORE VENTURI	1	PZ	VM1568A0	DISTANZIALE PIATTELLO VENTURI	1	PZ
Codice	Descrizione	Qtà	UM																																																										
GN1310A0	GUARNIZIONE PIATTELLO VENTURI SILICONE	1	PZ																																																										
GN1556A0	GUARNIZIONE VENTURI MM	1	PZ																																																										
RC1378A0	FASCETTA STRINGI TUBO ZINCATA	2	PZ																																																										
TB1520A0	TUBO D.INT=30 SP=4 GOMMA EPDM NERO	0.050	M																																																										
VE1135A0	ATTUATORE VENTURI 220V 50/60 HZ SERIE 2	1	PZ																																																										
VI1032A0	VITE M4X16 TCB+ INOX	1	PZ																																																										
VI1511A0	RONDELLA PIANA 4.2X12X1 INOX	2	PZ																																																										
VI1850A0	VITE M4X6 TCB+ NICHELATA	2	PZ																																																										
VI1865A0	VITE AUTOFIL. 5X10 TCB+	3	PZ																																																										
VM1565B0	PORTA BOBINA INFERIORE VENTURI CT B	1	PZ																																																										
VM1566A0	PORTA BOBINA SUPERIORE VENTURI	1	PZ																																																										
VM1567A0	BOCCOLA INFERIORE VENTURI	1	PZ																																																										
VM1568A0	DISTANZIALE PIATTELLO VENTURI	1	PZ																																																										

COMPONENTE			RICAMBIO																		
Codice	Descrizione	Immagine	Codice	Descrizione	Lista componenti																
VN1165A	VENTOLA RAFFREDDAMENTO 230VAC 50/60HZ 12		KVN1165A	KIT VENTOLA RAFFREDDAMENTO 120X120 230V	<table border="1"> <thead> <tr> <th>Codice</th> <th>Descrizione</th> <th>Qtà</th> <th>UM</th> </tr> </thead> <tbody> <tr> <td>V11099A0</td> <td>VITE AUTOFORANT E 4.8X13 TCB+ ZN</td> <td>4</td> <td>PZ</td> </tr> <tr> <td>VM1555A2</td> <td>SUPPORTO VENTOLA RAFFREDDAM ENTO CT BT</td> <td>1</td> <td>PZ</td> </tr> <tr> <td>VN1165A0</td> <td>VENTOLA RAFFREDDAM ENTO 230VAC 50/60HZ 12</td> <td>1</td> <td>PZ</td> </tr> </tbody> </table>	Codice	Descrizione	Qtà	UM	V11099A0	VITE AUTOFORANT E 4.8X13 TCB+ ZN	4	PZ	VM1555A2	SUPPORTO VENTOLA RAFFREDDAM ENTO CT BT	1	PZ	VN1165A0	VENTOLA RAFFREDDAM ENTO 230VAC 50/60HZ 12	1	PZ
Codice	Descrizione	Qtà	UM																		
V11099A0	VITE AUTOFORANT E 4.8X13 TCB+ ZN	4	PZ																		
VM1555A2	SUPPORTO VENTOLA RAFFREDDAM ENTO CT BT	1	PZ																		
VN1165A0	VENTOLA RAFFREDDAM ENTO 230VAC 50/60HZ 12	1	PZ																		
VM1556A	PROTEZIONE VENTOLA RAFFREDAMENTO CT BT		KVM1556A	KIT PROTEZIONE VENTOLA RAFFREDDAMENTO	<table border="1"> <thead> <tr> <th>Codice</th> <th>Descrizione</th> <th>Qtà</th> <th>UM</th> </tr> </thead> <tbody> <tr> <td>VM1556A0</td> <td>PROTEZIONE VENTOLA RAFFREDAME NTO CT BT</td> <td>1</td> <td>PZ</td> </tr> </tbody> </table>	Codice	Descrizione	Qtà	UM	VM1556A0	PROTEZIONE VENTOLA RAFFREDAME NTO CT BT	1	PZ								
Codice	Descrizione	Qtà	UM																		
VM1556A0	PROTEZIONE VENTOLA RAFFREDAME NTO CT BT	1	PZ																		
VM1555A	SUPPORTO VENTOLA RAFFREDDAMENTO CT BT																				
GN1558A	GUARNIZIONE TENUTA CAMINO		K0H7291A	KIT DISCO E GUARNIZIONE TENUTA CAMINO	<table border="1"> <thead> <tr> <th>Codice</th> <th>Descrizione</th> <th>Qtà</th> <th>UM</th> </tr> </thead> <tbody> <tr> <td>0H7291A0</td> <td>DISCO TENUTA CAMINO</td> <td>1</td> <td>PZ</td> </tr> <tr> <td>GN1558A0</td> <td>GUARNIZIONE TENUTA CAMINO</td> <td>1</td> <td>PZ</td> </tr> </tbody> </table>	Codice	Descrizione	Qtà	UM	0H7291A0	DISCO TENUTA CAMINO	1	PZ	GN1558A0	GUARNIZIONE TENUTA CAMINO	1	PZ				
Codice	Descrizione	Qtà	UM																		
0H7291A0	DISCO TENUTA CAMINO	1	PZ																		
GN1558A0	GUARNIZIONE TENUTA CAMINO	1	PZ																		
0H7291A	DISCO TENUTA CAMINO		K0H7291A	KIT DISCO E GUARNIZIONE TENUTA CAMINO	<table border="1"> <thead> <tr> <th>Codice</th> <th>Descrizione</th> <th>Qtà</th> <th>UM</th> </tr> </thead> <tbody> <tr> <td>0H7291A0</td> <td>DISCO TENUTA CAMINO</td> <td>1</td> <td>PZ</td> </tr> <tr> <td>GN1558A0</td> <td>GUARNIZIONE TENUTA CAMINO</td> <td>1</td> <td>PZ</td> </tr> </tbody> </table>	Codice	Descrizione	Qtà	UM	0H7291A0	DISCO TENUTA CAMINO	1	PZ	GN1558A0	GUARNIZIONE TENUTA CAMINO	1	PZ				
Codice	Descrizione	Qtà	UM																		
0H7291A0	DISCO TENUTA CAMINO	1	PZ																		
GN1558A0	GUARNIZIONE TENUTA CAMINO	1	PZ																		

COMPONENTE			RICAMBIO																										
Codice	Descrizione	Immagine	Codice	Descrizione	Lista componenti																								
0H2561A	CONTROSTAFFA PORTA MM		0H2561A0	CONTROSTAFFA PORTA MM																									
RC1055A	FASCETTA STRINGI TUBO Ø25-40 H12 INOX		KRC1055A	KIT 10 PZ FASCETTA STRINGI TUBO RC1055A0	<table border="1"> <thead> <tr> <th>Codice</th> <th>Descrizione</th> <th>Qtà</th> <th>UM</th> </tr> </thead> <tbody> <tr> <td>RC1055A0</td> <td>FASCETTA STRINGI TUBO Ø25-40 H12 INOX</td> <td>10</td> <td>PZ</td> </tr> </tbody> </table>	Codice	Descrizione	Qtà	UM	RC1055A0	FASCETTA STRINGI TUBO Ø25-40 H12 INOX	10	PZ																
Codice	Descrizione	Qtà	UM																										
RC1055A0	FASCETTA STRINGI TUBO Ø25-40 H12 INOX	10	PZ																										
0F1506A	SCHIENA SUPERIORE XEVC-2011		0F1506A0	SCHIENA SUPERIORE XEVC-2011																									
PD1078A	PIEDINO REGOLABILE 2" H147-190 LAMIERA		KPD1078A	KIT PIEDINI REGOLABILI 2" H147-190 4PZ	<table border="1"> <thead> <tr> <th>Codice</th> <th>Descrizione</th> <th>Qtà</th> <th>UM</th> </tr> </thead> <tbody> <tr> <td>PD1078A0</td> <td>PIEDINO REGOLABILE 2" H147-190 LAMIERA</td> <td>4</td> <td>PZ</td> </tr> </tbody> </table>	Codice	Descrizione	Qtà	UM	PD1078A0	PIEDINO REGOLABILE 2" H147-190 LAMIERA	4	PZ																
Codice	Descrizione	Qtà	UM																										
PD1078A0	PIEDINO REGOLABILE 2" H147-190 LAMIERA	4	PZ																										
VM1190A	SCROCCO MANIGLIA DX CT BT		KVM1190A	KIT SCROCCO MANIGLIA DX CT BT	<table border="1"> <thead> <tr> <th>Codice</th> <th>Descrizione</th> <th>Qtà</th> <th>UM</th> </tr> </thead> <tbody> <tr> <td>VI0239A1</td> <td>VITE AUTOFIL. 4.2X25 TCB+ INOX</td> <td>2</td> <td>PZ</td> </tr> <tr> <td>VI1220A1</td> <td>VITE AUTOFILETTA NTE 4.2X11 TCS+ MARUTE</td> <td>2</td> <td>PZ</td> </tr> <tr> <td>VM1190A2</td> <td>SCROCCO MANIGLIA DX CT BT</td> <td>1</td> <td>PZ</td> </tr> <tr> <td>VM1192A1</td> <td>COPERCHIO POST. SCROCCO MANIGLIA CT BT</td> <td>1</td> <td>PZ</td> </tr> <tr> <td>VM1460A0</td> <td>COPERCHIO DX SCROCCO PORTA XBC/XVC</td> <td>1</td> <td>PZ</td> </tr> </tbody> </table>	Codice	Descrizione	Qtà	UM	VI0239A1	VITE AUTOFIL. 4.2X25 TCB+ INOX	2	PZ	VI1220A1	VITE AUTOFILETTA NTE 4.2X11 TCS+ MARUTE	2	PZ	VM1190A2	SCROCCO MANIGLIA DX CT BT	1	PZ	VM1192A1	COPERCHIO POST. SCROCCO MANIGLIA CT BT	1	PZ	VM1460A0	COPERCHIO DX SCROCCO PORTA XBC/XVC	1	PZ
Codice	Descrizione	Qtà	UM																										
VI0239A1	VITE AUTOFIL. 4.2X25 TCB+ INOX	2	PZ																										
VI1220A1	VITE AUTOFILETTA NTE 4.2X11 TCS+ MARUTE	2	PZ																										
VM1190A2	SCROCCO MANIGLIA DX CT BT	1	PZ																										
VM1192A1	COPERCHIO POST. SCROCCO MANIGLIA CT BT	1	PZ																										
VM1460A0	COPERCHIO DX SCROCCO PORTA XBC/XVC	1	PZ																										

COMPONENTE			RICAMBIO																										
Codice	Descrizione	Immagine	Codice	Descrizione	Lista componenti																								
VM1192A	COPERCHIO POST. SCROCCO MANIGLIA CT BT		KVM1191A	KIT SCROCCO MANIGLIA SX CT BT	<table border="1"> <thead> <tr> <th>Codice</th> <th>Descrizione</th> <th>Qtà</th> <th>UM</th> </tr> </thead> <tbody> <tr> <td>VI0239A1</td> <td>VITE AUTOFIL. 4.2X25 TCB+ INOX</td> <td>2</td> <td>PZ</td> </tr> <tr> <td>VI1220A1</td> <td>VITE AUTOFILETTA NTE 4.2X11 TCS+ MARUTE</td> <td>2</td> <td>PZ</td> </tr> <tr> <td>VM1191A2</td> <td>SCROCCO MANIGLIA SX CT BT</td> <td>1</td> <td>PZ</td> </tr> <tr> <td>VM1192A1</td> <td>COPERCHIO POST. SCROCCO MANIGLIA CT BT</td> <td>1</td> <td>PZ</td> </tr> <tr> <td>VM1460A0</td> <td>COPERCHIO DX SCROCCO PORTA XBC/XVC</td> <td>1</td> <td>PZ</td> </tr> </tbody> </table>	Codice	Descrizione	Qtà	UM	VI0239A1	VITE AUTOFIL. 4.2X25 TCB+ INOX	2	PZ	VI1220A1	VITE AUTOFILETTA NTE 4.2X11 TCS+ MARUTE	2	PZ	VM1191A2	SCROCCO MANIGLIA SX CT BT	1	PZ	VM1192A1	COPERCHIO POST. SCROCCO MANIGLIA CT BT	1	PZ	VM1460A0	COPERCHIO DX SCROCCO PORTA XBC/XVC	1	PZ
			Codice	Descrizione	Qtà	UM																							
VI0239A1	VITE AUTOFIL. 4.2X25 TCB+ INOX	2	PZ																										
VI1220A1	VITE AUTOFILETTA NTE 4.2X11 TCS+ MARUTE	2	PZ																										
VM1191A2	SCROCCO MANIGLIA SX CT BT	1	PZ																										
VM1192A1	COPERCHIO POST. SCROCCO MANIGLIA CT BT	1	PZ																										
VM1460A0	COPERCHIO DX SCROCCO PORTA XBC/XVC	1	PZ																										
KVM1190A	KIT SCROCCO MANIGLIA DX CT BT	<table border="1"> <thead> <tr> <th>Codice</th> <th>Descrizione</th> <th>Qtà</th> <th>UM</th> </tr> </thead> <tbody> <tr> <td>VI0239A1</td> <td>VITE AUTOFIL. 4.2X25 TCB+ INOX</td> <td>2</td> <td>PZ</td> </tr> <tr> <td>VI1220A1</td> <td>VITE AUTOFILETTA NTE 4.2X11 TCS+ MARUTE</td> <td>2</td> <td>PZ</td> </tr> <tr> <td>VM1190A2</td> <td>SCROCCO MANIGLIA DX CT BT</td> <td>1</td> <td>PZ</td> </tr> <tr> <td>VM1192A1</td> <td>COPERCHIO POST. SCROCCO MANIGLIA CT BT</td> <td>1</td> <td>PZ</td> </tr> <tr> <td>VM1460A0</td> <td>COPERCHIO DX SCROCCO PORTA XBC/XVC</td> <td>1</td> <td>PZ</td> </tr> </tbody> </table>	Codice	Descrizione	Qtà	UM	VI0239A1	VITE AUTOFIL. 4.2X25 TCB+ INOX	2	PZ	VI1220A1	VITE AUTOFILETTA NTE 4.2X11 TCS+ MARUTE	2	PZ	VM1190A2	SCROCCO MANIGLIA DX CT BT	1	PZ	VM1192A1	COPERCHIO POST. SCROCCO MANIGLIA CT BT	1	PZ	VM1460A0	COPERCHIO DX SCROCCO PORTA XBC/XVC	1	PZ			
Codice	Descrizione	Qtà	UM																										
VI0239A1	VITE AUTOFIL. 4.2X25 TCB+ INOX	2	PZ																										
VI1220A1	VITE AUTOFILETTA NTE 4.2X11 TCS+ MARUTE	2	PZ																										
VM1190A2	SCROCCO MANIGLIA DX CT BT	1	PZ																										
VM1192A1	COPERCHIO POST. SCROCCO MANIGLIA CT BT	1	PZ																										
VM1460A0	COPERCHIO DX SCROCCO PORTA XBC/XVC	1	PZ																										
0H7274A	ASM GUIDA DX CARRELLO XEVC-2011		0H7274A0	ASM GUIDA DX CARRELLO XEVC-2011																									

COMPONENTE			RICAMBIO																																																														
Codice	Descrizione	Immagine	Codice	Descrizione	Lista componenti																																																												
0H7275A	ASM GUIDA SX CARRELLO XEVC-2011		0H7275A0	ASM GUIDA SX CARRELLO XEVC-2011																																																													
VL1005A	VASCA SIFONE		XUC001	KIT PRIMA INSTALLAZIONE	<table border="1"> <thead> <tr> <th>Codice</th> <th>Descrizione</th> <th>Qtà</th> <th>UM</th> </tr> </thead> <tbody> <tr> <td>0H6567A0</td> <td>LAMIERA SOSTEGNO SIFONE</td> <td>1</td> <td>PZ</td> </tr> <tr> <td>GN1508A0</td> <td>GUARNIZIONE O-RING COD 2400</td> <td>1</td> <td>PZ</td> </tr> <tr> <td>IL1115A0</td> <td>PALETTA LEGNO EPAL 1200X800X130</td> <td>0.100</td> <td>PZ</td> </tr> <tr> <td>RC1055A0</td> <td>FASCETTA STRINGI TUBO Ø25-40 H12 INOX</td> <td>3</td> <td>PZ</td> </tr> <tr> <td>TB1520A0</td> <td>TUBO D.INT=30 SP=4 GOMMA EPDM NERO</td> <td>2.500</td> <td>M</td> </tr> <tr> <td>TB3207A0</td> <td>TUBO D.50 PROLUNGA CAMINO S.C</td> <td>1</td> <td>PZ</td> </tr> <tr> <td>VI1075A0</td> <td>DADO M4 H=4 INOX UNI5587</td> <td>4</td> <td>PZ</td> </tr> <tr> <td>VI1220A1</td> <td>VITE AUTOFISETTA NTE 4.2X11 TCS+ MARUTE</td> <td>2</td> <td>PZ</td> </tr> <tr> <td>VI1895A0</td> <td>DADO CIECO M4 INOX DIN 917</td> <td>4</td> <td>PZ</td> </tr> <tr> <td>VI1945A0</td> <td>VITE M4X20 TCB+ INOX</td> <td>4</td> <td>PZ</td> </tr> <tr> <td>VI1950A0</td> <td>VITE AUTOFORANT E 4,2X13 TCB INOX</td> <td>2</td> <td>PZ</td> </tr> <tr> <td>VL1005A1</td> <td>VASCA SIFON</td> <td>1</td> <td>PZ</td> </tr> <tr> <td>VL1006A0</td> <td>COPERCHIO SIFONE</td> <td>1</td> <td>PZ</td> </tr> <tr> <td>VM1015A1</td> <td>CURVA A 90° INOX Ø30X1</td> <td>1</td> <td>PZ</td> </tr> </tbody> </table>	Codice	Descrizione	Qtà	UM	0H6567A0	LAMIERA SOSTEGNO SIFONE	1	PZ	GN1508A0	GUARNIZIONE O-RING COD 2400	1	PZ	IL1115A0	PALETTA LEGNO EPAL 1200X800X130	0.100	PZ	RC1055A0	FASCETTA STRINGI TUBO Ø25-40 H12 INOX	3	PZ	TB1520A0	TUBO D.INT=30 SP=4 GOMMA EPDM NERO	2.500	M	TB3207A0	TUBO D.50 PROLUNGA CAMINO S.C	1	PZ	VI1075A0	DADO M4 H=4 INOX UNI5587	4	PZ	VI1220A1	VITE AUTOFISETTA NTE 4.2X11 TCS+ MARUTE	2	PZ	VI1895A0	DADO CIECO M4 INOX DIN 917	4	PZ	VI1945A0	VITE M4X20 TCB+ INOX	4	PZ	VI1950A0	VITE AUTOFORANT E 4,2X13 TCB INOX	2	PZ	VL1005A1	VASCA SIFON	1	PZ	VL1006A0	COPERCHIO SIFONE	1	PZ	VM1015A1	CURVA A 90° INOX Ø30X1	1	PZ
Codice	Descrizione	Qtà	UM																																																														
0H6567A0	LAMIERA SOSTEGNO SIFONE	1	PZ																																																														
GN1508A0	GUARNIZIONE O-RING COD 2400	1	PZ																																																														
IL1115A0	PALETTA LEGNO EPAL 1200X800X130	0.100	PZ																																																														
RC1055A0	FASCETTA STRINGI TUBO Ø25-40 H12 INOX	3	PZ																																																														
TB1520A0	TUBO D.INT=30 SP=4 GOMMA EPDM NERO	2.500	M																																																														
TB3207A0	TUBO D.50 PROLUNGA CAMINO S.C	1	PZ																																																														
VI1075A0	DADO M4 H=4 INOX UNI5587	4	PZ																																																														
VI1220A1	VITE AUTOFISETTA NTE 4.2X11 TCS+ MARUTE	2	PZ																																																														
VI1895A0	DADO CIECO M4 INOX DIN 917	4	PZ																																																														
VI1945A0	VITE M4X20 TCB+ INOX	4	PZ																																																														
VI1950A0	VITE AUTOFORANT E 4,2X13 TCB INOX	2	PZ																																																														
VL1005A1	VASCA SIFON	1	PZ																																																														
VL1006A0	COPERCHIO SIFONE	1	PZ																																																														
VM1015A1	CURVA A 90° INOX Ø30X1	1	PZ																																																														

COMPONENTE			RICAMBIO																																																																						
Codice	Descrizione	Immagine	Codice	Descrizione	Lista componenti																																																																				
VL1005A	VASCA SIFONE		XC761	KIT SOVRAPPOSIZIONE 3 FORNI LM XFT200	<table border="1"> <thead> <tr> <th>Codice</th> <th>Descrizione</th> <th>Qtà</th> <th>UM</th> </tr> </thead> <tbody> <tr> <td>0H1237A0</td> <td>SUPPORTO SIFONE LM TO</td> <td>3</td> <td>PZ</td> </tr> <tr> <td>0H7082A0</td> <td>PROFILO FRONTALE KIT SOVRAP.LM 800 XC64</td> <td>2</td> <td>PZ</td> </tr> <tr> <td>0H7083A0</td> <td>PROFILO POSTERIORE KIT SOVRAP.LM 800 XC</td> <td>4</td> <td>PZ</td> </tr> <tr> <td>0H7084A0</td> <td>PROFILO FRONTALE KIT SOVRAP.LM60 0 XC651</td> <td>2</td> <td>PZ</td> </tr> <tr> <td>0H7085A0</td> <td>PROFILO POSTERIORE KIT SOVRAP.LM 600 XC</td> <td>4</td> <td>PZ</td> </tr> <tr> <td>ED1246A0</td> <td>ETICHETTA SUPERFICI CALDE</td> <td>1</td> <td>PZ</td> </tr> <tr> <td>ED1271A0</td> <td>ETICHETTA PERICOLO CADUTA LIQUIDI</td> <td>1</td> <td>PZ</td> </tr> <tr> <td>EL1020A0</td> <td>RACCORDO INTERMEDIO "T" TUBO Ø8</td> <td>4</td> <td>PZ</td> </tr> <tr> <td>EL1020A1</td> <td>RACCORDO INTERMEDIO "T" TUBO D8 J</td> <td>4</td> <td>PZ</td> </tr> <tr> <td>EL1180A0</td> <td>RACCORDO NON RITORNO Ø8 Ø8 FEMMIN</td> <td>3</td> <td>PZ</td> </tr> <tr> <td>GN1508A0</td> <td>GUARNIZIONE O-RING COD 2400</td> <td>3</td> <td>PZ</td> </tr> <tr> <td>RC1008A0</td> <td>FASCETTA ELASTICA D9 ZINCATA</td> <td>12</td> <td>PZ</td> </tr> <tr> <td>RC1055A0</td> <td>FASCETTA STRINGI TUBO Ø25-40 H12 INOX</td> <td>15</td> <td>PZ</td> </tr> <tr> <td>RC1297A0</td> <td>RACCORDO A T Ø10</td> <td>2</td> <td>PZ</td> </tr> <tr> <td>RC1297A1</td> <td>RACCORDO A T Ø10</td> <td>2</td> <td>PZ</td> </tr> <tr> <td>RC1360A0</td> <td>RACCORDO GOMITO JG 10-10</td> <td>1</td> <td>PZ</td> </tr> </tbody> </table>	Codice	Descrizione	Qtà	UM	0H1237A0	SUPPORTO SIFONE LM TO	3	PZ	0H7082A0	PROFILO FRONTALE KIT SOVRAP.LM 800 XC64	2	PZ	0H7083A0	PROFILO POSTERIORE KIT SOVRAP.LM 800 XC	4	PZ	0H7084A0	PROFILO FRONTALE KIT SOVRAP.LM60 0 XC651	2	PZ	0H7085A0	PROFILO POSTERIORE KIT SOVRAP.LM 600 XC	4	PZ	ED1246A0	ETICHETTA SUPERFICI CALDE	1	PZ	ED1271A0	ETICHETTA PERICOLO CADUTA LIQUIDI	1	PZ	EL1020A0	RACCORDO INTERMEDIO "T" TUBO Ø8	4	PZ	EL1020A1	RACCORDO INTERMEDIO "T" TUBO D8 J	4	PZ	EL1180A0	RACCORDO NON RITORNO Ø8 Ø8 FEMMIN	3	PZ	GN1508A0	GUARNIZIONE O-RING COD 2400	3	PZ	RC1008A0	FASCETTA ELASTICA D9 ZINCATA	12	PZ	RC1055A0	FASCETTA STRINGI TUBO Ø25-40 H12 INOX	15	PZ	RC1297A0	RACCORDO A T Ø10	2	PZ	RC1297A1	RACCORDO A T Ø10	2	PZ	RC1360A0	RACCORDO GOMITO JG 10-10	1	PZ
Codice	Descrizione	Qtà	UM																																																																						
0H1237A0	SUPPORTO SIFONE LM TO	3	PZ																																																																						
0H7082A0	PROFILO FRONTALE KIT SOVRAP.LM 800 XC64	2	PZ																																																																						
0H7083A0	PROFILO POSTERIORE KIT SOVRAP.LM 800 XC	4	PZ																																																																						
0H7084A0	PROFILO FRONTALE KIT SOVRAP.LM60 0 XC651	2	PZ																																																																						
0H7085A0	PROFILO POSTERIORE KIT SOVRAP.LM 600 XC	4	PZ																																																																						
ED1246A0	ETICHETTA SUPERFICI CALDE	1	PZ																																																																						
ED1271A0	ETICHETTA PERICOLO CADUTA LIQUIDI	1	PZ																																																																						
EL1020A0	RACCORDO INTERMEDIO "T" TUBO Ø8	4	PZ																																																																						
EL1020A1	RACCORDO INTERMEDIO "T" TUBO D8 J	4	PZ																																																																						
EL1180A0	RACCORDO NON RITORNO Ø8 Ø8 FEMMIN	3	PZ																																																																						
GN1508A0	GUARNIZIONE O-RING COD 2400	3	PZ																																																																						
RC1008A0	FASCETTA ELASTICA D9 ZINCATA	12	PZ																																																																						
RC1055A0	FASCETTA STRINGI TUBO Ø25-40 H12 INOX	15	PZ																																																																						
RC1297A0	RACCORDO A T Ø10	2	PZ																																																																						
RC1297A1	RACCORDO A T Ø10	2	PZ																																																																						
RC1360A0	RACCORDO GOMITO JG 10-10	1	PZ																																																																						

COMPONENTE			RICAMBIO																																																																																													
Codice	Descrizione	Immagine	Codice	Descrizione	Lista componenti																																																																																											
VL1005A	VASCA SIFONE		XC761	KIT SOVRAPPOSIZIONE 3 FORNI LM XFT200	<table border="1"> <thead> <tr> <th>Codice</th> <th>Descrizione</th> <th>Qtà</th> <th>UM</th> </tr> </thead> <tbody> <tr> <td>RC1376A0</td> <td>RACCORDO Y Ø6</td> <td>2</td> <td>PZ</td> </tr> <tr> <td>TB1177A0</td> <td>PIEDE QUADRO 40X40 H58 SOVRAP. LM</td> <td>8</td> <td>PZ</td> </tr> <tr> <td>TB1520A0</td> <td>TUBO D.INT=30 SP=4 GOMMA EPDM NERO</td> <td>5</td> <td>M</td> </tr> <tr> <td>TB1815A0</td> <td>TUBO PE 7,93X4,75 TRASPARENT</td> <td>12</td> <td>M</td> </tr> <tr> <td>TB1816A0</td> <td>TUBO PP 6X4 TRASPARENT</td> <td>3</td> <td>M</td> </tr> <tr> <td>TB2243A0</td> <td>TUBO PET Ø10</td> <td>4</td> <td>M</td> </tr> <tr> <td>VI1075A0</td> <td>DADO M4 H=4 INOX UNI5587</td> <td>12</td> <td>PZ</td> </tr> <tr> <td>VI1220A1</td> <td>VITE AUTOFILETTA NTE 4.2X11 TCS+ MARUTE</td> <td>30</td> <td>PZ</td> </tr> <tr> <td>VI1895A0</td> <td>DADO CIECO M4 INOX DIN 917</td> <td>12</td> <td>PZ</td> </tr> <tr> <td>VI1945A0</td> <td>VITE M4X20 TCB+ INOX</td> <td>12</td> <td>PZ</td> </tr> <tr> <td>VI1950A0</td> <td>VITE AUTOFORANT E 4,2X13 TCB INOX</td> <td>20</td> <td>PZ</td> </tr> <tr> <td>VL1005A1</td> <td>VASCA SIFON</td> <td>3</td> <td>PZ</td> </tr> <tr> <td>VL1006A0</td> <td>COPERCHIO SIFONE</td> <td>3</td> <td>PZ</td> </tr> <tr> <td>VL1046A1</td> <td>PORTAGOMM A D6-CODOLO D6</td> <td>12</td> <td>PZ</td> </tr> <tr> <td>VM1015A1</td> <td>CURVA A 90° INOX Ø30X1</td> <td>1</td> <td>PZ</td> </tr> <tr> <td>VM1794A0</td> <td>FASCETTA 250X4.8 PA66 NERA</td> <td>3</td> <td>PZ</td> </tr> <tr> <td>VM2035A0</td> <td>SUPPORTO PER TUBO DI SCARICO</td> <td>3</td> <td>PZ</td> </tr> </tbody> </table>	Codice	Descrizione	Qtà	UM	RC1376A0	RACCORDO Y Ø6	2	PZ	TB1177A0	PIEDE QUADRO 40X40 H58 SOVRAP. LM	8	PZ	TB1520A0	TUBO D.INT=30 SP=4 GOMMA EPDM NERO	5	M	TB1815A0	TUBO PE 7,93X4,75 TRASPARENT	12	M	TB1816A0	TUBO PP 6X4 TRASPARENT	3	M	TB2243A0	TUBO PET Ø10	4	M	VI1075A0	DADO M4 H=4 INOX UNI5587	12	PZ	VI1220A1	VITE AUTOFILETTA NTE 4.2X11 TCS+ MARUTE	30	PZ	VI1895A0	DADO CIECO M4 INOX DIN 917	12	PZ	VI1945A0	VITE M4X20 TCB+ INOX	12	PZ	VI1950A0	VITE AUTOFORANT E 4,2X13 TCB INOX	20	PZ	VL1005A1	VASCA SIFON	3	PZ	VL1006A0	COPERCHIO SIFONE	3	PZ	VL1046A1	PORTAGOMM A D6-CODOLO D6	12	PZ	VM1015A1	CURVA A 90° INOX Ø30X1	1	PZ	VM1794A0	FASCETTA 250X4.8 PA66 NERA	3	PZ	VM2035A0	SUPPORTO PER TUBO DI SCARICO	3	PZ	XC757	KIT SOVRAPPOSIZIONE CT 1/1 S.5E	<table border="1"> <thead> <tr> <th>Codice</th> <th>Descrizione</th> <th>Qtà</th> <th>UM</th> </tr> </thead> <tbody> <tr> <td>0H6463A0</td> <td>PROFILO FRONTALE PER XC757</td> <td>1</td> <td>PZ</td> </tr> <tr> <td>CE1305A0</td> <td>CAVO RJ45 - RJ45 L=2MT</td> <td>1</td> <td>PZ</td> </tr> <tr> <td>ED1246A0</td> <td>ETICHETTA SUPERFICI CALDE</td> <td>2</td> <td>PZ</td> </tr> </tbody> </table>	Codice	Descrizione	Qtà	UM	0H6463A0	PROFILO FRONTALE PER XC757	1	PZ	CE1305A0	CAVO RJ45 - RJ45 L=2MT	1	PZ	ED1246A0	ETICHETTA SUPERFICI CALDE	2	PZ
			Codice	Descrizione	Qtà	UM																																																																																										
RC1376A0	RACCORDO Y Ø6	2	PZ																																																																																													
TB1177A0	PIEDE QUADRO 40X40 H58 SOVRAP. LM	8	PZ																																																																																													
TB1520A0	TUBO D.INT=30 SP=4 GOMMA EPDM NERO	5	M																																																																																													
TB1815A0	TUBO PE 7,93X4,75 TRASPARENT	12	M																																																																																													
TB1816A0	TUBO PP 6X4 TRASPARENT	3	M																																																																																													
TB2243A0	TUBO PET Ø10	4	M																																																																																													
VI1075A0	DADO M4 H=4 INOX UNI5587	12	PZ																																																																																													
VI1220A1	VITE AUTOFILETTA NTE 4.2X11 TCS+ MARUTE	30	PZ																																																																																													
VI1895A0	DADO CIECO M4 INOX DIN 917	12	PZ																																																																																													
VI1945A0	VITE M4X20 TCB+ INOX	12	PZ																																																																																													
VI1950A0	VITE AUTOFORANT E 4,2X13 TCB INOX	20	PZ																																																																																													
VL1005A1	VASCA SIFON	3	PZ																																																																																													
VL1006A0	COPERCHIO SIFONE	3	PZ																																																																																													
VL1046A1	PORTAGOMM A D6-CODOLO D6	12	PZ																																																																																													
VM1015A1	CURVA A 90° INOX Ø30X1	1	PZ																																																																																													
VM1794A0	FASCETTA 250X4.8 PA66 NERA	3	PZ																																																																																													
VM2035A0	SUPPORTO PER TUBO DI SCARICO	3	PZ																																																																																													
Codice	Descrizione	Qtà	UM																																																																																													
0H6463A0	PROFILO FRONTALE PER XC757	1	PZ																																																																																													
CE1305A0	CAVO RJ45 - RJ45 L=2MT	1	PZ																																																																																													
ED1246A0	ETICHETTA SUPERFICI CALDE	2	PZ																																																																																													

COMPONENTE			RICAMBIO																																																																														
Codice	Descrizione	Immagine	Codice	Descrizione	Lista componenti																																																																												
VL1005A	VASCA SIFONE		XC757	KIT SOVRAPPOSIZIONE CT 1/1 S.5E	<table border="1"> <thead> <tr> <th>Codice</th> <th>Descrizione</th> <th>Qtà</th> <th>UM</th> </tr> </thead> <tbody> <tr> <td>ED1271A0</td> <td>ETICHETTA PERICOLO CADUTA LIQUIDI</td> <td>1</td> <td>PZ</td> </tr> <tr> <td>EL1020A0</td> <td>RACCORDO INTERMEDIO "T" TUBO Ø8</td> <td>2</td> <td>PZ</td> </tr> <tr> <td>EL1020A1</td> <td>RACCORDO INTERMEDIO "T" TUBO D8 J</td> <td>2</td> <td>PZ</td> </tr> <tr> <td>GN1508A0</td> <td>GUARNIZIONE O-RING COD 2400</td> <td>2</td> <td>PZ</td> </tr> <tr> <td>PD1069A0</td> <td>PIEDE SOVRAPPOSIZIONE CT-BT S5-E</td> <td>1</td> <td>PZ</td> </tr> <tr> <td>RC1008A0</td> <td>FASCETTA ELASTICA D9 ZINCATA</td> <td>3</td> <td>PZ</td> </tr> <tr> <td>RC1055A0</td> <td>FASCETTA STRINGI TUBO Ø25-40 H12 INOX</td> <td>14</td> <td>PZ</td> </tr> <tr> <td>RC1130A0</td> <td>FASCETTA 130X2,6</td> <td>3</td> <td>PZ</td> </tr> <tr> <td>RC1297A0</td> <td>RACCORDO A T Ø10</td> <td>1</td> <td>PZ</td> </tr> <tr> <td>RC1297A1</td> <td>RACCORDO A T Ø10</td> <td>1</td> <td>PZ</td> </tr> <tr> <td>RC1376A0</td> <td>RACCORDO Y Ø6</td> <td>1</td> <td>PZ</td> </tr> <tr> <td>TB1520A0</td> <td>TUBO D.INT=30 SP=4 GOMMA EPDM NERO</td> <td>5</td> <td>M</td> </tr> <tr> <td>TB1765A1</td> <td>TUBO RACCORDO CAMINO KIT SOVRAP. Ø30X1</td> <td>2</td> <td>PZ</td> </tr> <tr> <td>TB2243A0</td> <td>TUBO PET Ø10</td> <td>1.500</td> <td>M</td> </tr> <tr> <td>VI1075A0</td> <td>DADO M4 H=4 INOX UNI5587</td> <td>8</td> <td>PZ</td> </tr> <tr> <td>VI1220A1</td> <td>VITE AUTOFILETTA NTE 4.2X11 TCS+ MARUTE</td> <td>4</td> <td>PZ</td> </tr> <tr> <td>VI1895A0</td> <td>DADO CIECO M4 INOX DIN 917</td> <td>8</td> <td>PZ</td> </tr> <tr> <td>VI1945A0</td> <td>VITE M4X20 TCB+ INOX</td> <td>8</td> <td>PZ</td> </tr> </tbody> </table>	Codice	Descrizione	Qtà	UM	ED1271A0	ETICHETTA PERICOLO CADUTA LIQUIDI	1	PZ	EL1020A0	RACCORDO INTERMEDIO "T" TUBO Ø8	2	PZ	EL1020A1	RACCORDO INTERMEDIO "T" TUBO D8 J	2	PZ	GN1508A0	GUARNIZIONE O-RING COD 2400	2	PZ	PD1069A0	PIEDE SOVRAPPOSIZIONE CT-BT S5-E	1	PZ	RC1008A0	FASCETTA ELASTICA D9 ZINCATA	3	PZ	RC1055A0	FASCETTA STRINGI TUBO Ø25-40 H12 INOX	14	PZ	RC1130A0	FASCETTA 130X2,6	3	PZ	RC1297A0	RACCORDO A T Ø10	1	PZ	RC1297A1	RACCORDO A T Ø10	1	PZ	RC1376A0	RACCORDO Y Ø6	1	PZ	TB1520A0	TUBO D.INT=30 SP=4 GOMMA EPDM NERO	5	M	TB1765A1	TUBO RACCORDO CAMINO KIT SOVRAP. Ø30X1	2	PZ	TB2243A0	TUBO PET Ø10	1.500	M	VI1075A0	DADO M4 H=4 INOX UNI5587	8	PZ	VI1220A1	VITE AUTOFILETTA NTE 4.2X11 TCS+ MARUTE	4	PZ	VI1895A0	DADO CIECO M4 INOX DIN 917	8	PZ	VI1945A0	VITE M4X20 TCB+ INOX	8	PZ
Codice	Descrizione	Qtà	UM																																																																														
ED1271A0	ETICHETTA PERICOLO CADUTA LIQUIDI	1	PZ																																																																														
EL1020A0	RACCORDO INTERMEDIO "T" TUBO Ø8	2	PZ																																																																														
EL1020A1	RACCORDO INTERMEDIO "T" TUBO D8 J	2	PZ																																																																														
GN1508A0	GUARNIZIONE O-RING COD 2400	2	PZ																																																																														
PD1069A0	PIEDE SOVRAPPOSIZIONE CT-BT S5-E	1	PZ																																																																														
RC1008A0	FASCETTA ELASTICA D9 ZINCATA	3	PZ																																																																														
RC1055A0	FASCETTA STRINGI TUBO Ø25-40 H12 INOX	14	PZ																																																																														
RC1130A0	FASCETTA 130X2,6	3	PZ																																																																														
RC1297A0	RACCORDO A T Ø10	1	PZ																																																																														
RC1297A1	RACCORDO A T Ø10	1	PZ																																																																														
RC1376A0	RACCORDO Y Ø6	1	PZ																																																																														
TB1520A0	TUBO D.INT=30 SP=4 GOMMA EPDM NERO	5	M																																																																														
TB1765A1	TUBO RACCORDO CAMINO KIT SOVRAP. Ø30X1	2	PZ																																																																														
TB2243A0	TUBO PET Ø10	1.500	M																																																																														
VI1075A0	DADO M4 H=4 INOX UNI5587	8	PZ																																																																														
VI1220A1	VITE AUTOFILETTA NTE 4.2X11 TCS+ MARUTE	4	PZ																																																																														
VI1895A0	DADO CIECO M4 INOX DIN 917	8	PZ																																																																														
VI1945A0	VITE M4X20 TCB+ INOX	8	PZ																																																																														

COMPONENTE			RICAMBIO																																										
Codice	Descrizione	Immagine	Codice	Descrizione	Lista componenti																																								
VL1005A	VASCA SIFONE		XC757	KIT SOVRAPPOSIZIONE CT 1/1 S.5E	<table border="1"> <thead> <tr> <th>Codice</th> <th>Descrizione</th> <th>Qtà</th> <th>UM</th> </tr> </thead> <tbody> <tr> <td>VI1950A0</td> <td>VITE AUTOFORANT E 4,2X13 TCB INOX</td> <td>26</td> <td>PZ</td> </tr> <tr> <td>VL1005A1</td> <td>VASCA SIFON</td> <td>2</td> <td>PZ</td> </tr> <tr> <td>VL1006A0</td> <td>COPERCHIO SIFONE</td> <td>2</td> <td>PZ</td> </tr> <tr> <td>VL1043A0</td> <td>PORTAGOMM A D4-CODOLO D6</td> <td>3</td> <td>PZ</td> </tr> <tr> <td>VL1046A1</td> <td>PORTAGOMM A D6-CODOLO D6</td> <td>3</td> <td>PZ</td> </tr> <tr> <td>VM1015A1</td> <td>CURVA A 90° INOX Ø30X1</td> <td>1</td> <td>PZ</td> </tr> <tr> <td>VM1794A0</td> <td>FASCETTA 250X4.8 PA66 NERA</td> <td>3</td> <td>PZ</td> </tr> <tr> <td>VM1987A0</td> <td>STAFFA SOVRAPPOSIZ IONE FORNI</td> <td>1</td> <td>PZ</td> </tr> <tr> <td>VM2035A0</td> <td>SUPPORTO PER TUBO DI SCARICO</td> <td>2</td> <td>PZ</td> </tr> </tbody> </table>	Codice	Descrizione	Qtà	UM	VI1950A0	VITE AUTOFORANT E 4,2X13 TCB INOX	26	PZ	VL1005A1	VASCA SIFON	2	PZ	VL1006A0	COPERCHIO SIFONE	2	PZ	VL1043A0	PORTAGOMM A D4-CODOLO D6	3	PZ	VL1046A1	PORTAGOMM A D6-CODOLO D6	3	PZ	VM1015A1	CURVA A 90° INOX Ø30X1	1	PZ	VM1794A0	FASCETTA 250X4.8 PA66 NERA	3	PZ	VM1987A0	STAFFA SOVRAPPOSIZ IONE FORNI	1	PZ	VM2035A0	SUPPORTO PER TUBO DI SCARICO	2	PZ
			Codice	Descrizione	Qtà	UM																																							
VI1950A0	VITE AUTOFORANT E 4,2X13 TCB INOX	26	PZ																																										
VL1005A1	VASCA SIFON	2	PZ																																										
VL1006A0	COPERCHIO SIFONE	2	PZ																																										
VL1043A0	PORTAGOMM A D4-CODOLO D6	3	PZ																																										
VL1046A1	PORTAGOMM A D6-CODOLO D6	3	PZ																																										
VM1015A1	CURVA A 90° INOX Ø30X1	1	PZ																																										
VM1794A0	FASCETTA 250X4.8 PA66 NERA	3	PZ																																										
VM1987A0	STAFFA SOVRAPPOSIZ IONE FORNI	1	PZ																																										
VM2035A0	SUPPORTO PER TUBO DI SCARICO	2	PZ																																										
XC756	KIT SOVRAPPOSIZIONE CT 2/3 S.5E	<table border="1"> <thead> <tr> <th>Codice</th> <th>Descrizione</th> <th>Qtà</th> <th>UM</th> </tr> </thead> <tbody> <tr> <td>0H6462A0</td> <td>PROFILO FRONTALE PER XC756</td> <td>1</td> <td>PZ</td> </tr> <tr> <td>CE1305A0</td> <td>CAVO RJ45 - RJ45 L=2MT</td> <td>1</td> <td>PZ</td> </tr> <tr> <td>ED1246A0</td> <td>ETICHETTA SUPERFICI CALDE</td> <td>1</td> <td>PZ</td> </tr> <tr> <td>ED1271A0</td> <td>ETICHETTA PERICOLO CADUTA LIQUIDI</td> <td>1</td> <td>PZ</td> </tr> <tr> <td>EL1020A0</td> <td>RACCORDO INTERMEDIO "T" TUBO Ø8</td> <td>2</td> <td>PZ</td> </tr> <tr> <td>EL1020A1</td> <td>RACCORDO INTERMEDIO "T" TUBO D8 J</td> <td>2</td> <td>PZ</td> </tr> <tr> <td>GN1508A0</td> <td>GUARNIZIONE O-RING COD 2400</td> <td>2</td> <td>PZ</td> </tr> <tr> <td>PD1069A0</td> <td>PIEDE SOVRAPPOSIZ IONE CT-BT S5-E</td> <td>1</td> <td>PZ</td> </tr> <tr> <td>RC1008A0</td> <td>FASCETTA ELASTICA D9 ZINCATA</td> <td>3</td> <td>PZ</td> </tr> </tbody> </table>	Codice	Descrizione	Qtà	UM	0H6462A0	PROFILO FRONTALE PER XC756	1	PZ	CE1305A0	CAVO RJ45 - RJ45 L=2MT	1	PZ	ED1246A0	ETICHETTA SUPERFICI CALDE	1	PZ	ED1271A0	ETICHETTA PERICOLO CADUTA LIQUIDI	1	PZ	EL1020A0	RACCORDO INTERMEDIO "T" TUBO Ø8	2	PZ	EL1020A1	RACCORDO INTERMEDIO "T" TUBO D8 J	2	PZ	GN1508A0	GUARNIZIONE O-RING COD 2400	2	PZ	PD1069A0	PIEDE SOVRAPPOSIZ IONE CT-BT S5-E	1	PZ	RC1008A0	FASCETTA ELASTICA D9 ZINCATA	3	PZ			
Codice	Descrizione	Qtà	UM																																										
0H6462A0	PROFILO FRONTALE PER XC756	1	PZ																																										
CE1305A0	CAVO RJ45 - RJ45 L=2MT	1	PZ																																										
ED1246A0	ETICHETTA SUPERFICI CALDE	1	PZ																																										
ED1271A0	ETICHETTA PERICOLO CADUTA LIQUIDI	1	PZ																																										
EL1020A0	RACCORDO INTERMEDIO "T" TUBO Ø8	2	PZ																																										
EL1020A1	RACCORDO INTERMEDIO "T" TUBO D8 J	2	PZ																																										
GN1508A0	GUARNIZIONE O-RING COD 2400	2	PZ																																										
PD1069A0	PIEDE SOVRAPPOSIZ IONE CT-BT S5-E	1	PZ																																										
RC1008A0	FASCETTA ELASTICA D9 ZINCATA	3	PZ																																										

COMPONENTE			RICAMBIO																																																																																										
Codice	Descrizione	Immagine	Codice	Descrizione	Lista componenti																																																																																								
VL1005A	VASCA SIFONE		XC756	KIT SOVRAPPOSIZIONE CT 2/3 S.5E	<table border="1"> <thead> <tr> <th>Codice</th> <th>Descrizione</th> <th>Qtà</th> <th>UM</th> </tr> </thead> <tbody> <tr> <td>RC1055A0</td> <td>FASCETTA STRINGI TUBO Ø25-40 H12 INOX</td> <td>14</td> <td>PZ</td> </tr> <tr> <td>RC1130A0</td> <td>FASCETTA 130X2,6</td> <td>3</td> <td>PZ</td> </tr> <tr> <td>RC1297A0</td> <td>RACCORDO A T Ø10</td> <td>1</td> <td>PZ</td> </tr> <tr> <td>RC1297A1</td> <td>RACCORDO A T Ø10</td> <td>1</td> <td>PZ</td> </tr> <tr> <td>RC1376A0</td> <td>RACCORDO Y Ø6</td> <td>1</td> <td>PZ</td> </tr> <tr> <td>TB1520A0</td> <td>TUBO D.INT=30 SP=4 GOMMA EPDM NERO</td> <td>3</td> <td>M</td> </tr> <tr> <td>TB1765A1</td> <td>TUBO RACCORDO CAMINO KIT SOVRAP. Ø30X1</td> <td>1</td> <td>PZ</td> </tr> <tr> <td>TB2243A0</td> <td>TUBO PET Ø10</td> <td>1.500</td> <td>M</td> </tr> <tr> <td>VI1075A0</td> <td>DADO M4 H=4 INOX UNI5587</td> <td>8</td> <td>PZ</td> </tr> <tr> <td>VI1220A1</td> <td>VITE AUTOFILETTA NTE 4.2X11 TCS+ MARUTE</td> <td>4</td> <td>PZ</td> </tr> <tr> <td>VI1895A0</td> <td>DADO CIECO M4 INOX DIN 917</td> <td>8</td> <td>PZ</td> </tr> <tr> <td>VI1945A0</td> <td>VITE M4X20 TCB+ INOX</td> <td>8</td> <td>PZ</td> </tr> <tr> <td>VI1950A0</td> <td>VITE AUTOFORANT E 4,2X13 TCB INOX</td> <td>26</td> <td>PZ</td> </tr> <tr> <td>VL1005A1</td> <td>VASCA SIFON</td> <td>2</td> <td>PZ</td> </tr> <tr> <td>VL1006A0</td> <td>COPERCHIO SIFONE</td> <td>2</td> <td>PZ</td> </tr> <tr> <td>VL1043A0</td> <td>PORTAGOMM A D4-CODOLO D6</td> <td>3</td> <td>PZ</td> </tr> <tr> <td>VL1046A1</td> <td>PORTAGOMM A D6-CODOLO D6</td> <td>3</td> <td>PZ</td> </tr> <tr> <td>VM1015A1</td> <td>CURVA A 90° INOX Ø30X1</td> <td>1</td> <td>PZ</td> </tr> <tr> <td>VM1794A0</td> <td>FASCETTA 250X4.8 PA66 NERA</td> <td>3</td> <td>PZ</td> </tr> <tr> <td>VM1987A0</td> <td>STAFFA SOVRAPPOSIZIONE FORNI</td> <td>1</td> <td>PZ</td> </tr> <tr> <td>VM2035A0</td> <td>SUPPORTO PER TUBO DI SCARICO</td> <td>1</td> <td>PZ</td> </tr> </tbody> </table>	Codice	Descrizione	Qtà	UM	RC1055A0	FASCETTA STRINGI TUBO Ø25-40 H12 INOX	14	PZ	RC1130A0	FASCETTA 130X2,6	3	PZ	RC1297A0	RACCORDO A T Ø10	1	PZ	RC1297A1	RACCORDO A T Ø10	1	PZ	RC1376A0	RACCORDO Y Ø6	1	PZ	TB1520A0	TUBO D.INT=30 SP=4 GOMMA EPDM NERO	3	M	TB1765A1	TUBO RACCORDO CAMINO KIT SOVRAP. Ø30X1	1	PZ	TB2243A0	TUBO PET Ø10	1.500	M	VI1075A0	DADO M4 H=4 INOX UNI5587	8	PZ	VI1220A1	VITE AUTOFILETTA NTE 4.2X11 TCS+ MARUTE	4	PZ	VI1895A0	DADO CIECO M4 INOX DIN 917	8	PZ	VI1945A0	VITE M4X20 TCB+ INOX	8	PZ	VI1950A0	VITE AUTOFORANT E 4,2X13 TCB INOX	26	PZ	VL1005A1	VASCA SIFON	2	PZ	VL1006A0	COPERCHIO SIFONE	2	PZ	VL1043A0	PORTAGOMM A D4-CODOLO D6	3	PZ	VL1046A1	PORTAGOMM A D6-CODOLO D6	3	PZ	VM1015A1	CURVA A 90° INOX Ø30X1	1	PZ	VM1794A0	FASCETTA 250X4.8 PA66 NERA	3	PZ	VM1987A0	STAFFA SOVRAPPOSIZIONE FORNI	1	PZ	VM2035A0	SUPPORTO PER TUBO DI SCARICO	1	PZ
Codice	Descrizione	Qtà	UM																																																																																										
RC1055A0	FASCETTA STRINGI TUBO Ø25-40 H12 INOX	14	PZ																																																																																										
RC1130A0	FASCETTA 130X2,6	3	PZ																																																																																										
RC1297A0	RACCORDO A T Ø10	1	PZ																																																																																										
RC1297A1	RACCORDO A T Ø10	1	PZ																																																																																										
RC1376A0	RACCORDO Y Ø6	1	PZ																																																																																										
TB1520A0	TUBO D.INT=30 SP=4 GOMMA EPDM NERO	3	M																																																																																										
TB1765A1	TUBO RACCORDO CAMINO KIT SOVRAP. Ø30X1	1	PZ																																																																																										
TB2243A0	TUBO PET Ø10	1.500	M																																																																																										
VI1075A0	DADO M4 H=4 INOX UNI5587	8	PZ																																																																																										
VI1220A1	VITE AUTOFILETTA NTE 4.2X11 TCS+ MARUTE	4	PZ																																																																																										
VI1895A0	DADO CIECO M4 INOX DIN 917	8	PZ																																																																																										
VI1945A0	VITE M4X20 TCB+ INOX	8	PZ																																																																																										
VI1950A0	VITE AUTOFORANT E 4,2X13 TCB INOX	26	PZ																																																																																										
VL1005A1	VASCA SIFON	2	PZ																																																																																										
VL1006A0	COPERCHIO SIFONE	2	PZ																																																																																										
VL1043A0	PORTAGOMM A D4-CODOLO D6	3	PZ																																																																																										
VL1046A1	PORTAGOMM A D6-CODOLO D6	3	PZ																																																																																										
VM1015A1	CURVA A 90° INOX Ø30X1	1	PZ																																																																																										
VM1794A0	FASCETTA 250X4.8 PA66 NERA	3	PZ																																																																																										
VM1987A0	STAFFA SOVRAPPOSIZIONE FORNI	1	PZ																																																																																										
VM2035A0	SUPPORTO PER TUBO DI SCARICO	1	PZ																																																																																										

COMPONENTE			RICAMBIO																																																																														
Codice	Descrizione	Immagine	Codice	Descrizione	Lista componenti																																																																												
VL1005A	VASCA SIFONE		XC755	KIT SOVRAPPOSIZIONE BT-CT 2/1 S.5E	<table border="1"> <thead> <tr> <th>Codice</th> <th>Descrizione</th> <th>Qtà</th> <th>UM</th> </tr> </thead> <tbody> <tr> <td>0H6461A0</td> <td>PROFILO FRONTALE PER XC755</td> <td>1</td> <td>PZ</td> </tr> <tr> <td>CE1635A0</td> <td>CAVO RJ45 - RJ45 L=3MT</td> <td>1</td> <td>PZ</td> </tr> <tr> <td>ED1246A0</td> <td>ETICHETTA SUPERFICI CALDE</td> <td>2</td> <td>PZ</td> </tr> <tr> <td>ED1271A0</td> <td>ETICHETTA PERICOLO CADUTA LIQUIDI</td> <td>1</td> <td>PZ</td> </tr> <tr> <td>EL1020A0</td> <td>RACCORDO INTERMEDIO "T" TUBO Ø8</td> <td>2</td> <td>PZ</td> </tr> <tr> <td>EL1020A1</td> <td>RACCORDO INTERMEDIO "T" TUBO D8 J</td> <td>2</td> <td>PZ</td> </tr> <tr> <td>GN1508A0</td> <td>GUARNIZIONE O-RING COD 2400</td> <td>2</td> <td>PZ</td> </tr> <tr> <td>PD1069A0</td> <td>PIEDE SOVRAPPOSIZIONE CT-BT S5-E</td> <td>1</td> <td>PZ</td> </tr> <tr> <td>RC1008A0</td> <td>FASCETTA ELASTICA D9 ZINCATA</td> <td>3</td> <td>PZ</td> </tr> <tr> <td>RC1055A0</td> <td>FASCETTA STRINGI TUBO Ø25-40 H12 INOX</td> <td>14</td> <td>PZ</td> </tr> <tr> <td>RC1130A0</td> <td>FASCETTA 130X2,6</td> <td>3</td> <td>PZ</td> </tr> <tr> <td>RC1297A0</td> <td>RACCORDO A T Ø10</td> <td>1</td> <td>PZ</td> </tr> <tr> <td>RC1297A1</td> <td>RACCORDO A T Ø10</td> <td>1</td> <td>PZ</td> </tr> <tr> <td>RC1376A0</td> <td>RACCORDO Y Ø6</td> <td>1</td> <td>PZ</td> </tr> <tr> <td>TB1520A0</td> <td>TUBO D.INT=30 SP=4 GOMMA EPDM NERO</td> <td>5</td> <td>M</td> </tr> <tr> <td>TB1765A1</td> <td>TUBO RACCORDO CAMINO KIT SOVRAP. Ø30X1</td> <td>2</td> <td>PZ</td> </tr> <tr> <td>TB2243A0</td> <td>TUBO PET Ø10 1.500</td> <td>1.500</td> <td>M</td> </tr> <tr> <td>VI1075A0</td> <td>DADO M4 H=4 INOX UNI5587</td> <td>8</td> <td>PZ</td> </tr> </tbody> </table>	Codice	Descrizione	Qtà	UM	0H6461A0	PROFILO FRONTALE PER XC755	1	PZ	CE1635A0	CAVO RJ45 - RJ45 L=3MT	1	PZ	ED1246A0	ETICHETTA SUPERFICI CALDE	2	PZ	ED1271A0	ETICHETTA PERICOLO CADUTA LIQUIDI	1	PZ	EL1020A0	RACCORDO INTERMEDIO "T" TUBO Ø8	2	PZ	EL1020A1	RACCORDO INTERMEDIO "T" TUBO D8 J	2	PZ	GN1508A0	GUARNIZIONE O-RING COD 2400	2	PZ	PD1069A0	PIEDE SOVRAPPOSIZIONE CT-BT S5-E	1	PZ	RC1008A0	FASCETTA ELASTICA D9 ZINCATA	3	PZ	RC1055A0	FASCETTA STRINGI TUBO Ø25-40 H12 INOX	14	PZ	RC1130A0	FASCETTA 130X2,6	3	PZ	RC1297A0	RACCORDO A T Ø10	1	PZ	RC1297A1	RACCORDO A T Ø10	1	PZ	RC1376A0	RACCORDO Y Ø6	1	PZ	TB1520A0	TUBO D.INT=30 SP=4 GOMMA EPDM NERO	5	M	TB1765A1	TUBO RACCORDO CAMINO KIT SOVRAP. Ø30X1	2	PZ	TB2243A0	TUBO PET Ø10 1.500	1.500	M	VI1075A0	DADO M4 H=4 INOX UNI5587	8	PZ
Codice	Descrizione	Qtà	UM																																																																														
0H6461A0	PROFILO FRONTALE PER XC755	1	PZ																																																																														
CE1635A0	CAVO RJ45 - RJ45 L=3MT	1	PZ																																																																														
ED1246A0	ETICHETTA SUPERFICI CALDE	2	PZ																																																																														
ED1271A0	ETICHETTA PERICOLO CADUTA LIQUIDI	1	PZ																																																																														
EL1020A0	RACCORDO INTERMEDIO "T" TUBO Ø8	2	PZ																																																																														
EL1020A1	RACCORDO INTERMEDIO "T" TUBO D8 J	2	PZ																																																																														
GN1508A0	GUARNIZIONE O-RING COD 2400	2	PZ																																																																														
PD1069A0	PIEDE SOVRAPPOSIZIONE CT-BT S5-E	1	PZ																																																																														
RC1008A0	FASCETTA ELASTICA D9 ZINCATA	3	PZ																																																																														
RC1055A0	FASCETTA STRINGI TUBO Ø25-40 H12 INOX	14	PZ																																																																														
RC1130A0	FASCETTA 130X2,6	3	PZ																																																																														
RC1297A0	RACCORDO A T Ø10	1	PZ																																																																														
RC1297A1	RACCORDO A T Ø10	1	PZ																																																																														
RC1376A0	RACCORDO Y Ø6	1	PZ																																																																														
TB1520A0	TUBO D.INT=30 SP=4 GOMMA EPDM NERO	5	M																																																																														
TB1765A1	TUBO RACCORDO CAMINO KIT SOVRAP. Ø30X1	2	PZ																																																																														
TB2243A0	TUBO PET Ø10 1.500	1.500	M																																																																														
VI1075A0	DADO M4 H=4 INOX UNI5587	8	PZ																																																																														

COMPONENTE			RICAMBIO																																																						
Codice	Descrizione	Immagine	Codice	Descrizione	Lista componenti																																																				
VL1005A	VASCA SIFONE		XC755	KIT SOVRAPPOSIZIONE BT-CT 2/1 S.5E	<table border="1"> <thead> <tr> <th>Codice</th> <th>Descrizione</th> <th>Qtà</th> <th>UM</th> </tr> </thead> <tbody> <tr> <td>VI1220A1</td> <td>VITE AUTOFILETTA NTE 4.2X11 TCS+ MARUTE</td> <td>4</td> <td>PZ</td> </tr> <tr> <td>VI1895A0</td> <td>DADO CIECO M4 INOX DIN 917</td> <td>8</td> <td>PZ</td> </tr> <tr> <td>VI1945A0</td> <td>VITE M4X20 TCB+ INOX</td> <td>8</td> <td>PZ</td> </tr> <tr> <td>VI1950A0</td> <td>VITE AUTOFORANT E 4,2X13 TCB INOX</td> <td>26</td> <td>PZ</td> </tr> <tr> <td>VL1005A1</td> <td>VASCA SIFON</td> <td>2</td> <td>PZ</td> </tr> <tr> <td>VL1006A0</td> <td>COPERCHIO SIFONE</td> <td>2</td> <td>PZ</td> </tr> <tr> <td>VL1043A0</td> <td>PORTAGOMM A D4-CODOLO D6</td> <td>3</td> <td>PZ</td> </tr> <tr> <td>VL1046A1</td> <td>PORTAGOMM A D6-CODOLO D6</td> <td>3</td> <td>PZ</td> </tr> <tr> <td>VM1015A1</td> <td>CURVA A 90° INOX Ø30X1</td> <td>1</td> <td>PZ</td> </tr> <tr> <td>VM1794A0</td> <td>FASCETTA 250X4.8 PA66 NERA</td> <td>3</td> <td>PZ</td> </tr> <tr> <td>VM1987A0</td> <td>STAFFA SOVRAPPOSIZIONE FORNI</td> <td>1</td> <td>PZ</td> </tr> <tr> <td>VM2035A0</td> <td>SUPPORTO PER TUBO DI SCARICO</td> <td>2</td> <td>PZ</td> </tr> </tbody> </table>	Codice	Descrizione	Qtà	UM	VI1220A1	VITE AUTOFILETTA NTE 4.2X11 TCS+ MARUTE	4	PZ	VI1895A0	DADO CIECO M4 INOX DIN 917	8	PZ	VI1945A0	VITE M4X20 TCB+ INOX	8	PZ	VI1950A0	VITE AUTOFORANT E 4,2X13 TCB INOX	26	PZ	VL1005A1	VASCA SIFON	2	PZ	VL1006A0	COPERCHIO SIFONE	2	PZ	VL1043A0	PORTAGOMM A D4-CODOLO D6	3	PZ	VL1046A1	PORTAGOMM A D6-CODOLO D6	3	PZ	VM1015A1	CURVA A 90° INOX Ø30X1	1	PZ	VM1794A0	FASCETTA 250X4.8 PA66 NERA	3	PZ	VM1987A0	STAFFA SOVRAPPOSIZIONE FORNI	1	PZ	VM2035A0	SUPPORTO PER TUBO DI SCARICO	2	PZ
Codice	Descrizione	Qtà	UM																																																						
VI1220A1	VITE AUTOFILETTA NTE 4.2X11 TCS+ MARUTE	4	PZ																																																						
VI1895A0	DADO CIECO M4 INOX DIN 917	8	PZ																																																						
VI1945A0	VITE M4X20 TCB+ INOX	8	PZ																																																						
VI1950A0	VITE AUTOFORANT E 4,2X13 TCB INOX	26	PZ																																																						
VL1005A1	VASCA SIFON	2	PZ																																																						
VL1006A0	COPERCHIO SIFONE	2	PZ																																																						
VL1043A0	PORTAGOMM A D4-CODOLO D6	3	PZ																																																						
VL1046A1	PORTAGOMM A D6-CODOLO D6	3	PZ																																																						
VM1015A1	CURVA A 90° INOX Ø30X1	1	PZ																																																						
VM1794A0	FASCETTA 250X4.8 PA66 NERA	3	PZ																																																						
VM1987A0	STAFFA SOVRAPPOSIZIONE FORNI	1	PZ																																																						
VM2035A0	SUPPORTO PER TUBO DI SCARICO	2	PZ																																																						
			XC699	KIT PRIMA INSTALLAZIONE LM TOP	<table border="1"> <thead> <tr> <th>Codice</th> <th>Descrizione</th> <th>Qtà</th> <th>UM</th> </tr> </thead> <tbody> <tr> <td>0H1237A0</td> <td>SUPPORTO SIFONE LM TO</td> <td>1</td> <td>PZ</td> </tr> <tr> <td>GN1508A0</td> <td>GUARNIZIONE O-RING COD 2400</td> <td>1</td> <td>PZ</td> </tr> <tr> <td>RC1055A0</td> <td>FASCETTA STRINGI TUBO Ø25-40 H12 INOX</td> <td>4</td> <td>PZ</td> </tr> <tr> <td>TB1520A0</td> <td>TUBO D.INT=30 SP=4 GOMMA EPDM NERO</td> <td>2.500</td> <td>M</td> </tr> <tr> <td>VI1075A0</td> <td>DADO M4 H=4 INOX UNI5587</td> <td>4</td> <td>PZ</td> </tr> <tr> <td>VI1220A1</td> <td>VITE AUTOFILETTA NTE 4.2X11 TCS+ MARUTE</td> <td>2</td> <td>PZ</td> </tr> </tbody> </table>	Codice	Descrizione	Qtà	UM	0H1237A0	SUPPORTO SIFONE LM TO	1	PZ	GN1508A0	GUARNIZIONE O-RING COD 2400	1	PZ	RC1055A0	FASCETTA STRINGI TUBO Ø25-40 H12 INOX	4	PZ	TB1520A0	TUBO D.INT=30 SP=4 GOMMA EPDM NERO	2.500	M	VI1075A0	DADO M4 H=4 INOX UNI5587	4	PZ	VI1220A1	VITE AUTOFILETTA NTE 4.2X11 TCS+ MARUTE	2	PZ																								
Codice	Descrizione	Qtà	UM																																																						
0H1237A0	SUPPORTO SIFONE LM TO	1	PZ																																																						
GN1508A0	GUARNIZIONE O-RING COD 2400	1	PZ																																																						
RC1055A0	FASCETTA STRINGI TUBO Ø25-40 H12 INOX	4	PZ																																																						
TB1520A0	TUBO D.INT=30 SP=4 GOMMA EPDM NERO	2.500	M																																																						
VI1075A0	DADO M4 H=4 INOX UNI5587	4	PZ																																																						
VI1220A1	VITE AUTOFILETTA NTE 4.2X11 TCS+ MARUTE	2	PZ																																																						

COMPONENTE			RICAMBIO																																															
Codice	Descrizione	Immagine	Codice	Descrizione	Lista componenti																																													
VL1005A	VASCA SIFONE		XC699	KIT PRIMA INSTALLAZIONE LM TOP	<table border="1"> <thead> <tr> <th>Codice</th> <th>Descrizione</th> <th>Qtà</th> <th>UM</th> </tr> </thead> <tbody> <tr> <td>VI1895A0</td> <td>DADO CIECO M4 INOX DIN 917</td> <td>4</td> <td>PZ</td> </tr> <tr> <td>VI1945A0</td> <td>VITE M4X20 TCB+ INOX</td> <td>4</td> <td>PZ</td> </tr> <tr> <td>VI1950A0</td> <td>VITE AUTOFORANT E 4,2X13 TCB INOX</td> <td>2</td> <td>PZ</td> </tr> <tr> <td>VL1005A1</td> <td>VASCA SIFON</td> <td>1</td> <td>PZ</td> </tr> <tr> <td>VL1006A0</td> <td>COPERCHIO SIFONE</td> <td>1</td> <td>PZ</td> </tr> <tr> <td>VM1015A1</td> <td>CURVA A 90° INOX Ø30X1</td> <td>1</td> <td>PZ</td> </tr> </tbody> </table>	Codice	Descrizione	Qtà	UM	VI1895A0	DADO CIECO M4 INOX DIN 917	4	PZ	VI1945A0	VITE M4X20 TCB+ INOX	4	PZ	VI1950A0	VITE AUTOFORANT E 4,2X13 TCB INOX	2	PZ	VL1005A1	VASCA SIFON	1	PZ	VL1006A0	COPERCHIO SIFONE	1	PZ	VM1015A1	CURVA A 90° INOX Ø30X1	1	PZ																	
			Codice	Descrizione	Qtà	UM																																												
			VI1895A0	DADO CIECO M4 INOX DIN 917	4	PZ																																												
VI1945A0	VITE M4X20 TCB+ INOX	4	PZ																																															
VI1950A0	VITE AUTOFORANT E 4,2X13 TCB INOX	2	PZ																																															
VL1005A1	VASCA SIFON	1	PZ																																															
VL1006A0	COPERCHIO SIFONE	1	PZ																																															
VM1015A1	CURVA A 90° INOX Ø30X1	1	PZ																																															
XC693	KIT PRIMA INSTALLAZIONE CT BT CL BL	<table border="1"> <thead> <tr> <th>Codice</th> <th>Descrizione</th> <th>Qtà</th> <th>UM</th> </tr> </thead> <tbody> <tr> <td>GN1508A0</td> <td>GUARNIZIONE O-RING COD 2400</td> <td>1</td> <td>PZ</td> </tr> <tr> <td>RC1055A0</td> <td>FASCETTA STRINGI TUBO Ø25-40 H12 INOX</td> <td>3</td> <td>PZ</td> </tr> <tr> <td>TB1520A0</td> <td>TUBO D.INT=30 SP=4 GOMMA EPDM NERO</td> <td>2.500</td> <td>M</td> </tr> <tr> <td>VI1075A0</td> <td>DADO M4 H=4 INOX UNI5587</td> <td>4</td> <td>PZ</td> </tr> <tr> <td>VI1220A1</td> <td>VITE AUTOFILETTA NTE 4.2X11 TCS+ MARUTE</td> <td>2</td> <td>PZ</td> </tr> <tr> <td>VI1895A0</td> <td>DADO CIECO M4 INOX DIN 917</td> <td>4</td> <td>PZ</td> </tr> <tr> <td>VI1945A0</td> <td>VITE M4X20 TCB+ INOX</td> <td>4</td> <td>PZ</td> </tr> <tr> <td>VI1950A0</td> <td>VITE AUTOFORANT E 4,2X13 TCB INOX</td> <td>2</td> <td>PZ</td> </tr> <tr> <td>VL1005A1</td> <td>VASCA SIFON</td> <td>1</td> <td>PZ</td> </tr> <tr> <td>VL1006A0</td> <td>COPERCHIO SIFONE</td> <td>1</td> <td>PZ</td> </tr> <tr> <td>VM1015A1</td> <td>CURVA A 90° INOX Ø30X1</td> <td>1</td> <td>PZ</td> </tr> </tbody> </table>	Codice	Descrizione	Qtà	UM	GN1508A0	GUARNIZIONE O-RING COD 2400	1	PZ	RC1055A0	FASCETTA STRINGI TUBO Ø25-40 H12 INOX	3	PZ	TB1520A0	TUBO D.INT=30 SP=4 GOMMA EPDM NERO	2.500	M	VI1075A0	DADO M4 H=4 INOX UNI5587	4	PZ	VI1220A1	VITE AUTOFILETTA NTE 4.2X11 TCS+ MARUTE	2	PZ	VI1895A0	DADO CIECO M4 INOX DIN 917	4	PZ	VI1945A0	VITE M4X20 TCB+ INOX	4	PZ	VI1950A0	VITE AUTOFORANT E 4,2X13 TCB INOX	2	PZ	VL1005A1	VASCA SIFON	1	PZ	VL1006A0	COPERCHIO SIFONE	1	PZ	VM1015A1	CURVA A 90° INOX Ø30X1	1	PZ
Codice	Descrizione	Qtà	UM																																															
GN1508A0	GUARNIZIONE O-RING COD 2400	1	PZ																																															
RC1055A0	FASCETTA STRINGI TUBO Ø25-40 H12 INOX	3	PZ																																															
TB1520A0	TUBO D.INT=30 SP=4 GOMMA EPDM NERO	2.500	M																																															
VI1075A0	DADO M4 H=4 INOX UNI5587	4	PZ																																															
VI1220A1	VITE AUTOFILETTA NTE 4.2X11 TCS+ MARUTE	2	PZ																																															
VI1895A0	DADO CIECO M4 INOX DIN 917	4	PZ																																															
VI1945A0	VITE M4X20 TCB+ INOX	4	PZ																																															
VI1950A0	VITE AUTOFORANT E 4,2X13 TCB INOX	2	PZ																																															
VL1005A1	VASCA SIFON	1	PZ																																															
VL1006A0	COPERCHIO SIFONE	1	PZ																																															
VM1015A1	CURVA A 90° INOX Ø30X1	1	PZ																																															
XC673	KIT SIFONE COMPLETO	<table border="1"> <thead> <tr> <th>Codice</th> <th>Descrizione</th> <th>Qtà</th> <th>UM</th> </tr> </thead> <tbody> <tr> <td>GN1508A0</td> <td>GUARNIZIONE O-RING COD 2400</td> <td>1</td> <td>PZ</td> </tr> </tbody> </table>	Codice	Descrizione	Qtà	UM	GN1508A0	GUARNIZIONE O-RING COD 2400	1	PZ																																								
Codice	Descrizione	Qtà	UM																																															
GN1508A0	GUARNIZIONE O-RING COD 2400	1	PZ																																															



COMPONENTE			RICAMBIO																																										
Codice	Descrizione	Immagine	Codice	Descrizione	Lista componenti																																								
VL1005A	VASCA SIFONE		XC673	KIT SIFONE COMPLETO	<table border="1"> <thead> <tr> <th>Codice</th> <th>Descrizione</th> <th>Qtà</th> <th>UM</th> </tr> </thead> <tbody> <tr> <td>RC1055A0</td> <td>FASCETTA STRINGI TUBO Ø25-40 H12 INOX</td> <td>2</td> <td>PZ</td> </tr> <tr> <td>TB1520A0</td> <td>TUBO D.INT=30 SP=4 GOMMA EPDM NERO</td> <td>0.050</td> <td>M</td> </tr> <tr> <td>VI1075A0</td> <td>DADO M4 H=4 INOX UNI5587</td> <td>4</td> <td>PZ</td> </tr> <tr> <td>VI1220A1</td> <td>VITE AUTOFILETTA NTE 4.2X11 TCS+ MARUTE</td> <td>2</td> <td>PZ</td> </tr> <tr> <td>VI1895A0</td> <td>DADO CIECO M4 INOX DIN 917</td> <td>4</td> <td>PZ</td> </tr> <tr> <td>VI1945A0</td> <td>VITE M4X20 TCB+ INOX</td> <td>4</td> <td>PZ</td> </tr> <tr> <td>VI1950A0</td> <td>VITE AUTOFORANT E 4,2X13 TCB INOX</td> <td>2</td> <td>PZ</td> </tr> <tr> <td>VL1005A1</td> <td>VASCA SIFON</td> <td>1</td> <td>PZ</td> </tr> <tr> <td>VL1006A0</td> <td>COPERCHIO SIFONE</td> <td>1</td> <td>PZ</td> </tr> </tbody> </table>	Codice	Descrizione	Qtà	UM	RC1055A0	FASCETTA STRINGI TUBO Ø25-40 H12 INOX	2	PZ	TB1520A0	TUBO D.INT=30 SP=4 GOMMA EPDM NERO	0.050	M	VI1075A0	DADO M4 H=4 INOX UNI5587	4	PZ	VI1220A1	VITE AUTOFILETTA NTE 4.2X11 TCS+ MARUTE	2	PZ	VI1895A0	DADO CIECO M4 INOX DIN 917	4	PZ	VI1945A0	VITE M4X20 TCB+ INOX	4	PZ	VI1950A0	VITE AUTOFORANT E 4,2X13 TCB INOX	2	PZ	VL1005A1	VASCA SIFON	1	PZ	VL1006A0	COPERCHIO SIFONE	1	PZ
			Codice	Descrizione	Qtà	UM																																							
RC1055A0	FASCETTA STRINGI TUBO Ø25-40 H12 INOX	2	PZ																																										
TB1520A0	TUBO D.INT=30 SP=4 GOMMA EPDM NERO	0.050	M																																										
VI1075A0	DADO M4 H=4 INOX UNI5587	4	PZ																																										
VI1220A1	VITE AUTOFILETTA NTE 4.2X11 TCS+ MARUTE	2	PZ																																										
VI1895A0	DADO CIECO M4 INOX DIN 917	4	PZ																																										
VI1945A0	VITE M4X20 TCB+ INOX	4	PZ																																										
VI1950A0	VITE AUTOFORANT E 4,2X13 TCB INOX	2	PZ																																										
VL1005A1	VASCA SIFON	1	PZ																																										
VL1006A0	COPERCHIO SIFONE	1	PZ																																										
XC653	KIT SOVRAPPOSIZIONE LM TOP 600	<table border="1"> <thead> <tr> <th>Codice</th> <th>Descrizione</th> <th>Qtà</th> <th>UM</th> </tr> </thead> <tbody> <tr> <td>0H1237A0</td> <td>SUPPORTO SIFONE LM TO</td> <td>2</td> <td>PZ</td> </tr> <tr> <td>0H7084A0</td> <td>PROFILO FRONTALE KIT SOVRAP.LM60 0 XC651</td> <td>1</td> <td>PZ</td> </tr> <tr> <td>0H7085A0</td> <td>PROFILO POSTERIORE KIT SOVRAP.LM 600 XC</td> <td>2</td> <td>PZ</td> </tr> <tr> <td>ED1246A0</td> <td>ETICHETTA SUPERFICI CALDE</td> <td>1</td> <td>PZ</td> </tr> <tr> <td>ED1271A0</td> <td>ETICHETTA PERICOLO CADUTA LIQUIDI</td> <td>1</td> <td>PZ</td> </tr> <tr> <td>EL1020A0</td> <td>RACCORDO INTERMEDIO "T" TUBO Ø8</td> <td>2</td> <td>PZ</td> </tr> <tr> <td>EL1020A1</td> <td>RACCORDO INTERMEDIO "T" TUBO D8 J</td> <td>2</td> <td>PZ</td> </tr> </tbody> </table>	Codice	Descrizione	Qtà	UM	0H1237A0	SUPPORTO SIFONE LM TO	2	PZ	0H7084A0	PROFILO FRONTALE KIT SOVRAP.LM60 0 XC651	1	PZ	0H7085A0	PROFILO POSTERIORE KIT SOVRAP.LM 600 XC	2	PZ	ED1246A0	ETICHETTA SUPERFICI CALDE	1	PZ	ED1271A0	ETICHETTA PERICOLO CADUTA LIQUIDI	1	PZ	EL1020A0	RACCORDO INTERMEDIO "T" TUBO Ø8	2	PZ	EL1020A1	RACCORDO INTERMEDIO "T" TUBO D8 J	2	PZ											
Codice	Descrizione	Qtà	UM																																										
0H1237A0	SUPPORTO SIFONE LM TO	2	PZ																																										
0H7084A0	PROFILO FRONTALE KIT SOVRAP.LM60 0 XC651	1	PZ																																										
0H7085A0	PROFILO POSTERIORE KIT SOVRAP.LM 600 XC	2	PZ																																										
ED1246A0	ETICHETTA SUPERFICI CALDE	1	PZ																																										
ED1271A0	ETICHETTA PERICOLO CADUTA LIQUIDI	1	PZ																																										
EL1020A0	RACCORDO INTERMEDIO "T" TUBO Ø8	2	PZ																																										
EL1020A1	RACCORDO INTERMEDIO "T" TUBO D8 J	2	PZ																																										

COMPONENTE			RICAMBIO																																																																																						
Codice	Descrizione	Immagine	Codice	Descrizione	Lista componenti																																																																																				
VL1005A	VASCA SIFONE		XC653	KIT SOVRAPPOSIZIONE LM TOP 600	<table border="1"> <thead> <tr> <th>Codice</th> <th>Descrizione</th> <th>Qtà</th> <th>UM</th> </tr> </thead> <tbody> <tr> <td>EL1180A0</td> <td>RACCORDO NON RITORNO Ø8 Ø8 FEMMIN</td> <td>2</td> <td>PZ</td> </tr> <tr> <td>GN1508A0</td> <td>GUARNIZIONE O-RING COD 2400</td> <td>2</td> <td>PZ</td> </tr> <tr> <td>RC1008A0</td> <td>FASCETTA ELASTICA D9 ZINCATA</td> <td>7</td> <td>PZ</td> </tr> <tr> <td>RC1055A0</td> <td>FASCETTA STRINGI TUBO Ø25-40 H12 INOX</td> <td>10</td> <td>PZ</td> </tr> <tr> <td>RC1297A0</td> <td>RACCORDO A T Ø10</td> <td>1</td> <td>PZ</td> </tr> <tr> <td>RC1297A1</td> <td>RACCORDO A T Ø10</td> <td>1</td> <td>PZ</td> </tr> <tr> <td>RC1360A0</td> <td>RACCORDO GOMITO JG 10-10</td> <td>1</td> <td>PZ</td> </tr> <tr> <td>RC1376A0</td> <td>RACCORDO Y Ø6</td> <td>1</td> <td>PZ</td> </tr> <tr> <td>TB1177A0</td> <td>PIEDE QUADRO 40X40 H58 SOVRAP. LM</td> <td>4</td> <td>PZ</td> </tr> <tr> <td>TB1520A0</td> <td>TUBO D.INT=30 SP=4 GOMMA EPDM NERO</td> <td>2.700</td> <td>M</td> </tr> <tr> <td>TB1815A0</td> <td>TUBO PE 7,93X4,75 TRASPARENT</td> <td>2</td> <td>M</td> </tr> <tr> <td>TB2243A0</td> <td>TUBO PET Ø10</td> <td>1.500</td> <td>M</td> </tr> <tr> <td>VI1075A0</td> <td>DADO M4 H=4 INOX UNI5587</td> <td>8</td> <td>PZ</td> </tr> <tr> <td>VI1220A1</td> <td>VITE AUTOFILETTA NTE 4.2X11 TCS+ MARUTE</td> <td>16</td> <td>PZ</td> </tr> <tr> <td>VI1895A0</td> <td>DADO CIECO M4 INOX DIN 917</td> <td>8</td> <td>PZ</td> </tr> <tr> <td>VI1945A0</td> <td>VITE M4X20 TCB+ INOX</td> <td>8</td> <td>PZ</td> </tr> <tr> <td>VI1950A0</td> <td>VITE AUTOFORANT E 4,2X13 TCB INOX</td> <td>10</td> <td>PZ</td> </tr> <tr> <td>VL1005A1</td> <td>VASCA SIFON</td> <td>2</td> <td>PZ</td> </tr> <tr> <td>VL1006A0</td> <td>COPERCHIO SIFONE</td> <td>2</td> <td>PZ</td> </tr> <tr> <td>VL1046A1</td> <td>PORTAGOMM A D6-CODOLO D6</td> <td>7</td> <td>PZ</td> </tr> </tbody> </table>	Codice	Descrizione	Qtà	UM	EL1180A0	RACCORDO NON RITORNO Ø8 Ø8 FEMMIN	2	PZ	GN1508A0	GUARNIZIONE O-RING COD 2400	2	PZ	RC1008A0	FASCETTA ELASTICA D9 ZINCATA	7	PZ	RC1055A0	FASCETTA STRINGI TUBO Ø25-40 H12 INOX	10	PZ	RC1297A0	RACCORDO A T Ø10	1	PZ	RC1297A1	RACCORDO A T Ø10	1	PZ	RC1360A0	RACCORDO GOMITO JG 10-10	1	PZ	RC1376A0	RACCORDO Y Ø6	1	PZ	TB1177A0	PIEDE QUADRO 40X40 H58 SOVRAP. LM	4	PZ	TB1520A0	TUBO D.INT=30 SP=4 GOMMA EPDM NERO	2.700	M	TB1815A0	TUBO PE 7,93X4,75 TRASPARENT	2	M	TB2243A0	TUBO PET Ø10	1.500	M	VI1075A0	DADO M4 H=4 INOX UNI5587	8	PZ	VI1220A1	VITE AUTOFILETTA NTE 4.2X11 TCS+ MARUTE	16	PZ	VI1895A0	DADO CIECO M4 INOX DIN 917	8	PZ	VI1945A0	VITE M4X20 TCB+ INOX	8	PZ	VI1950A0	VITE AUTOFORANT E 4,2X13 TCB INOX	10	PZ	VL1005A1	VASCA SIFON	2	PZ	VL1006A0	COPERCHIO SIFONE	2	PZ	VL1046A1	PORTAGOMM A D6-CODOLO D6	7	PZ
Codice	Descrizione	Qtà	UM																																																																																						
EL1180A0	RACCORDO NON RITORNO Ø8 Ø8 FEMMIN	2	PZ																																																																																						
GN1508A0	GUARNIZIONE O-RING COD 2400	2	PZ																																																																																						
RC1008A0	FASCETTA ELASTICA D9 ZINCATA	7	PZ																																																																																						
RC1055A0	FASCETTA STRINGI TUBO Ø25-40 H12 INOX	10	PZ																																																																																						
RC1297A0	RACCORDO A T Ø10	1	PZ																																																																																						
RC1297A1	RACCORDO A T Ø10	1	PZ																																																																																						
RC1360A0	RACCORDO GOMITO JG 10-10	1	PZ																																																																																						
RC1376A0	RACCORDO Y Ø6	1	PZ																																																																																						
TB1177A0	PIEDE QUADRO 40X40 H58 SOVRAP. LM	4	PZ																																																																																						
TB1520A0	TUBO D.INT=30 SP=4 GOMMA EPDM NERO	2.700	M																																																																																						
TB1815A0	TUBO PE 7,93X4,75 TRASPARENT	2	M																																																																																						
TB2243A0	TUBO PET Ø10	1.500	M																																																																																						
VI1075A0	DADO M4 H=4 INOX UNI5587	8	PZ																																																																																						
VI1220A1	VITE AUTOFILETTA NTE 4.2X11 TCS+ MARUTE	16	PZ																																																																																						
VI1895A0	DADO CIECO M4 INOX DIN 917	8	PZ																																																																																						
VI1945A0	VITE M4X20 TCB+ INOX	8	PZ																																																																																						
VI1950A0	VITE AUTOFORANT E 4,2X13 TCB INOX	10	PZ																																																																																						
VL1005A1	VASCA SIFON	2	PZ																																																																																						
VL1006A0	COPERCHIO SIFONE	2	PZ																																																																																						
VL1046A1	PORTAGOMM A D6-CODOLO D6	7	PZ																																																																																						

COMPONENTE			RICAMBIO																																																							
Codice	Descrizione	Immagine	Codice	Descrizione	Lista componenti																																																					
VL1005A	VASCA SIFONE		XC653	KIT SOVRAPPOSIZIONE LM TOP 600	<table border="1"> <thead> <tr> <th>Codice</th> <th>Descrizione</th> <th>Qtà</th> <th>UM</th> </tr> </thead> <tbody> <tr> <td>VL1047A1</td> <td>PORTAGOMM A D6 CODOLO D8</td> <td>2</td> <td>PZ</td> </tr> <tr> <td>VL1047A2</td> <td>PORTAGOMM A D6 CODOLO D8</td> <td>2</td> <td>PZ</td> </tr> <tr> <td>VM1015A1</td> <td>CURVA A 90° INOX Ø30X1</td> <td>1</td> <td>PZ</td> </tr> <tr> <td>VM1794A0</td> <td>FASCETTA 250X4.8 PA66 NERA</td> <td>2</td> <td>PZ</td> </tr> <tr> <td>VM2035A0</td> <td>SUPPORTO PER TUBO DI SCARICO</td> <td>1</td> <td>PZ</td> </tr> </tbody> </table>	Codice	Descrizione	Qtà	UM	VL1047A1	PORTAGOMM A D6 CODOLO D8	2	PZ	VL1047A2	PORTAGOMM A D6 CODOLO D8	2	PZ	VM1015A1	CURVA A 90° INOX Ø30X1	1	PZ	VM1794A0	FASCETTA 250X4.8 PA66 NERA	2	PZ	VM2035A0	SUPPORTO PER TUBO DI SCARICO	1	PZ																													
			Codice	Descrizione	Qtà	UM																																																				
VL1047A1	PORTAGOMM A D6 CODOLO D8	2	PZ																																																							
VL1047A2	PORTAGOMM A D6 CODOLO D8	2	PZ																																																							
VM1015A1	CURVA A 90° INOX Ø30X1	1	PZ																																																							
VM1794A0	FASCETTA 250X4.8 PA66 NERA	2	PZ																																																							
VM2035A0	SUPPORTO PER TUBO DI SCARICO	1	PZ																																																							
XC649	KIT SOVRAPPOSIZIONE LM TOP 800 USA	<table border="1"> <thead> <tr> <th>Codice</th> <th>Descrizione</th> <th>Qtà</th> <th>UM</th> </tr> </thead> <tbody> <tr> <td>0H1151A0</td> <td>STAFFA FISSAGGIO LIEVITATORE-FORNO</td> <td>4</td> <td>PZ</td> </tr> <tr> <td>0H1237A0</td> <td>SUPPORTO SIFONE LM TO</td> <td>2</td> <td>PZ</td> </tr> <tr> <td>ED1335A0</td> <td>ETICHETTA TRIANGOLO CAUTION HOT</td> <td>1</td> <td>PZ</td> </tr> <tr> <td>ED1338A0</td> <td>ETICHETTA PERICOLO CADUTA LIQUIDI UL</td> <td>1</td> <td>PZ</td> </tr> <tr> <td>EL1020A0</td> <td>RACCORDO INTERMEDIO "T" TUBO Ø8</td> <td>2</td> <td>PZ</td> </tr> <tr> <td>EL1020A1</td> <td>RACCORDO INTERMEDIO "T" TUBO D8 J</td> <td>2</td> <td>PZ</td> </tr> <tr> <td>EL1185A0</td> <td>RACCORDO A GOMITO J.GUEST Ø8F - Ø8F</td> <td>2</td> <td>PZ</td> </tr> <tr> <td>EL1185B0</td> <td>RACCORDO A GOMITO Ø8F-Ø8F</td> <td>2</td> <td>PZ</td> </tr> <tr> <td>GN1508A0</td> <td>GUARNIZIONE O-RING COD 2400</td> <td>2</td> <td>PZ</td> </tr> <tr> <td>RC1008A0</td> <td>FASCETTA ELASTICA D9 ZINCATA</td> <td>3</td> <td>PZ</td> </tr> <tr> <td>RC1055A0</td> <td>FASCETTA STRINGI TUBO Ø25-40 H12 INOX</td> <td>8</td> <td>PZ</td> </tr> <tr> <td>RC1297A0</td> <td>RACCORDO A T Ø10</td> <td>1</td> <td>PZ</td> </tr> <tr> <td>RC1297A1</td> <td>RACCORDO A T Ø10</td> <td>1</td> <td>PZ</td> </tr> </tbody> </table>	Codice	Descrizione	Qtà	UM	0H1151A0	STAFFA FISSAGGIO LIEVITATORE-FORNO	4	PZ	0H1237A0	SUPPORTO SIFONE LM TO	2	PZ	ED1335A0	ETICHETTA TRIANGOLO CAUTION HOT	1	PZ	ED1338A0	ETICHETTA PERICOLO CADUTA LIQUIDI UL	1	PZ	EL1020A0	RACCORDO INTERMEDIO "T" TUBO Ø8	2	PZ	EL1020A1	RACCORDO INTERMEDIO "T" TUBO D8 J	2	PZ	EL1185A0	RACCORDO A GOMITO J.GUEST Ø8F - Ø8F	2	PZ	EL1185B0	RACCORDO A GOMITO Ø8F-Ø8F	2	PZ	GN1508A0	GUARNIZIONE O-RING COD 2400	2	PZ	RC1008A0	FASCETTA ELASTICA D9 ZINCATA	3	PZ	RC1055A0	FASCETTA STRINGI TUBO Ø25-40 H12 INOX	8	PZ	RC1297A0	RACCORDO A T Ø10	1	PZ	RC1297A1	RACCORDO A T Ø10	1	PZ
Codice	Descrizione	Qtà	UM																																																							
0H1151A0	STAFFA FISSAGGIO LIEVITATORE-FORNO	4	PZ																																																							
0H1237A0	SUPPORTO SIFONE LM TO	2	PZ																																																							
ED1335A0	ETICHETTA TRIANGOLO CAUTION HOT	1	PZ																																																							
ED1338A0	ETICHETTA PERICOLO CADUTA LIQUIDI UL	1	PZ																																																							
EL1020A0	RACCORDO INTERMEDIO "T" TUBO Ø8	2	PZ																																																							
EL1020A1	RACCORDO INTERMEDIO "T" TUBO D8 J	2	PZ																																																							
EL1185A0	RACCORDO A GOMITO J.GUEST Ø8F - Ø8F	2	PZ																																																							
EL1185B0	RACCORDO A GOMITO Ø8F-Ø8F	2	PZ																																																							
GN1508A0	GUARNIZIONE O-RING COD 2400	2	PZ																																																							
RC1008A0	FASCETTA ELASTICA D9 ZINCATA	3	PZ																																																							
RC1055A0	FASCETTA STRINGI TUBO Ø25-40 H12 INOX	8	PZ																																																							
RC1297A0	RACCORDO A T Ø10	1	PZ																																																							
RC1297A1	RACCORDO A T Ø10	1	PZ																																																							

COMPONENTE			RICAMBIO																																																																																					
Codice	Descrizione	Immagine	Codice	Descrizione	Lista componenti																																																																																			
VL1005A	VASCA SIFONE		XC649	KIT SOVRAPPOSIZIONE LM TOP 800 USA	<table border="1"> <thead> <tr> <th>Codice</th> <th>Descrizione</th> <th>Qtà</th> <th>UM</th> </tr> </thead> <tbody> <tr> <td>RC1360A0</td> <td>RACCORDO GOMITO JG 10-10</td> <td>1</td> <td>PZ</td> </tr> <tr> <td>RC1376A0</td> <td>RACCORDO Y Ø6</td> <td>1</td> <td>PZ</td> </tr> <tr> <td>TB1520A0</td> <td>TUBO D.INT=30 SP=4 GOMMA EPDM NERO</td> <td>2.840</td> <td>M</td> </tr> <tr> <td>TB1815A0</td> <td>TUBO PE 7,93X4,75 TRASPARENT</td> <td>2</td> <td>M</td> </tr> <tr> <td>TB2243A0</td> <td>TUBO PET Ø10</td> <td>1.500</td> <td>M</td> </tr> <tr> <td>VI1075A0</td> <td>DADO M4 H=4 INOX UNI5587</td> <td>8</td> <td>PZ</td> </tr> <tr> <td>VI1220A1</td> <td>VITE AUTOFILETTA NTE 4.2X11 TCS+ MARUTE</td> <td>7</td> <td>PZ</td> </tr> <tr> <td>VI1895A0</td> <td>DADO CIECO M4 INOX DIN 917</td> <td>8</td> <td>PZ</td> </tr> <tr> <td>VI1945A0</td> <td>VITE M4X20 TCB+ INOX</td> <td>8</td> <td>PZ</td> </tr> <tr> <td>VI1950A0</td> <td>VITE AUTOFORANT E 4,2X13 TCB INOX</td> <td>6</td> <td>PZ</td> </tr> <tr> <td>VL1005A1</td> <td>VASCA SIFON</td> <td>2</td> <td>PZ</td> </tr> <tr> <td>VL1006A0</td> <td>COPERCHIO SIFONE</td> <td>2</td> <td>PZ</td> </tr> <tr> <td>VL1046A1</td> <td>PORTAGOMM A D6-CODOLO D6</td> <td>3</td> <td>PZ</td> </tr> <tr> <td>VM1794A0</td> <td>FASCETTA 250X4.8 PA66 NERA</td> <td>2</td> <td>PZ</td> </tr> <tr> <td>VM2035A0</td> <td>SUPPORTO PER TUBO DI SCARICO</td> <td>1</td> <td>PZ</td> </tr> </tbody> </table>	Codice	Descrizione	Qtà	UM	RC1360A0	RACCORDO GOMITO JG 10-10	1	PZ	RC1376A0	RACCORDO Y Ø6	1	PZ	TB1520A0	TUBO D.INT=30 SP=4 GOMMA EPDM NERO	2.840	M	TB1815A0	TUBO PE 7,93X4,75 TRASPARENT	2	M	TB2243A0	TUBO PET Ø10	1.500	M	VI1075A0	DADO M4 H=4 INOX UNI5587	8	PZ	VI1220A1	VITE AUTOFILETTA NTE 4.2X11 TCS+ MARUTE	7	PZ	VI1895A0	DADO CIECO M4 INOX DIN 917	8	PZ	VI1945A0	VITE M4X20 TCB+ INOX	8	PZ	VI1950A0	VITE AUTOFORANT E 4,2X13 TCB INOX	6	PZ	VL1005A1	VASCA SIFON	2	PZ	VL1006A0	COPERCHIO SIFONE	2	PZ	VL1046A1	PORTAGOMM A D6-CODOLO D6	3	PZ	VM1794A0	FASCETTA 250X4.8 PA66 NERA	2	PZ	VM2035A0	SUPPORTO PER TUBO DI SCARICO	1	PZ	XC648	KIT SOVRAPPOSIZIONE LM TOP 800	<table border="1"> <thead> <tr> <th>Codice</th> <th>Descrizione</th> <th>Qtà</th> <th>UM</th> </tr> </thead> <tbody> <tr> <td>0H1237A0</td> <td>SUPPORTO SIFONE LM TO</td> <td>2</td> <td>PZ</td> </tr> <tr> <td>0H7082A0</td> <td>PROFILO FRONTALE KIT SOVRAP.LM 800 XC64</td> <td>1</td> <td>PZ</td> </tr> <tr> <td>0H7083A0</td> <td>PROFILO POSTERIORE KIT SOVRAP.LM 800 XC</td> <td>2</td> <td>PZ</td> </tr> </tbody> </table>	Codice	Descrizione	Qtà	UM	0H1237A0	SUPPORTO SIFONE LM TO	2	PZ	0H7082A0	PROFILO FRONTALE KIT SOVRAP.LM 800 XC64	1	PZ	0H7083A0	PROFILO POSTERIORE KIT SOVRAP.LM 800 XC	2	PZ
			Codice	Descrizione	Qtà	UM																																																																																		
RC1360A0	RACCORDO GOMITO JG 10-10	1	PZ																																																																																					
RC1376A0	RACCORDO Y Ø6	1	PZ																																																																																					
TB1520A0	TUBO D.INT=30 SP=4 GOMMA EPDM NERO	2.840	M																																																																																					
TB1815A0	TUBO PE 7,93X4,75 TRASPARENT	2	M																																																																																					
TB2243A0	TUBO PET Ø10	1.500	M																																																																																					
VI1075A0	DADO M4 H=4 INOX UNI5587	8	PZ																																																																																					
VI1220A1	VITE AUTOFILETTA NTE 4.2X11 TCS+ MARUTE	7	PZ																																																																																					
VI1895A0	DADO CIECO M4 INOX DIN 917	8	PZ																																																																																					
VI1945A0	VITE M4X20 TCB+ INOX	8	PZ																																																																																					
VI1950A0	VITE AUTOFORANT E 4,2X13 TCB INOX	6	PZ																																																																																					
VL1005A1	VASCA SIFON	2	PZ																																																																																					
VL1006A0	COPERCHIO SIFONE	2	PZ																																																																																					
VL1046A1	PORTAGOMM A D6-CODOLO D6	3	PZ																																																																																					
VM1794A0	FASCETTA 250X4.8 PA66 NERA	2	PZ																																																																																					
VM2035A0	SUPPORTO PER TUBO DI SCARICO	1	PZ																																																																																					
Codice	Descrizione	Qtà	UM																																																																																					
0H1237A0	SUPPORTO SIFONE LM TO	2	PZ																																																																																					
0H7082A0	PROFILO FRONTALE KIT SOVRAP.LM 800 XC64	1	PZ																																																																																					
0H7083A0	PROFILO POSTERIORE KIT SOVRAP.LM 800 XC	2	PZ																																																																																					

COMPONENTE			RICAMBIO																																																																														
Codice	Descrizione	Immagine	Codice	Descrizione	Lista componenti																																																																												
VL1005A	VASCA SIFONE		XC648	KIT SOVRAPPOSIZIONE LM TOP 800	<table border="1"> <thead> <tr> <th>Codice</th> <th>Descrizione</th> <th>Qtà</th> <th>UM</th> </tr> </thead> <tbody> <tr> <td>ED1246A0</td> <td>ETICHETTA SUPERFICI CALDE</td> <td>1</td> <td>PZ</td> </tr> <tr> <td>ED1271A0</td> <td>ETICHETTA PERICOLO CADUTA LIQUIDI</td> <td>1</td> <td>PZ</td> </tr> <tr> <td>EL1020A0</td> <td>RACCORDO INTERMEDIO "T" TUBO Ø8</td> <td>2</td> <td>PZ</td> </tr> <tr> <td>EL1020A1</td> <td>RACCORDO INTERMEDIO "T" TUBO D8 J</td> <td>2</td> <td>PZ</td> </tr> <tr> <td>EL1180A0</td> <td>RACCORDO NON RITORNO Ø8 Ø8 FEMMIN</td> <td>2</td> <td>PZ</td> </tr> <tr> <td>GN1508A0</td> <td>GUARNIZIONE O-RING COD 2400</td> <td>2</td> <td>PZ</td> </tr> <tr> <td>RC1008A0</td> <td>FASCETTA ELASTICA D9 ZINCATA</td> <td>7</td> <td>PZ</td> </tr> <tr> <td>RC1055A0</td> <td>FASCETTA STRINGI TUBO Ø25-40 H12 INOX</td> <td>10</td> <td>PZ</td> </tr> <tr> <td>RC1297A0</td> <td>RACCORDO A T Ø10</td> <td>1</td> <td>PZ</td> </tr> <tr> <td>RC1297A1</td> <td>RACCORDO A T Ø10</td> <td>1</td> <td>PZ</td> </tr> <tr> <td>RC1360A0</td> <td>RACCORDO GOMITO JG 10-10</td> <td>1</td> <td>PZ</td> </tr> <tr> <td>RC1376A0</td> <td>RACCORDO Y Ø6</td> <td>1</td> <td>PZ</td> </tr> <tr> <td>TB1177A0</td> <td>PIEDE QUADRO 40X40 H58 SOVRAP. LM</td> <td>4</td> <td>PZ</td> </tr> <tr> <td>TB1520A0</td> <td>TUBO D.INT=30 SP=4 GOMMA EPDM NERO</td> <td>2.700</td> <td>M</td> </tr> <tr> <td>TB1815A0</td> <td>TUBO PE 7,93X4,75 TRASPARENT</td> <td>2</td> <td>M</td> </tr> <tr> <td>TB2243A0</td> <td>TUBO PET Ø10</td> <td>1.500</td> <td>M</td> </tr> <tr> <td>VI1075A0</td> <td>DADO M4 H=4 INOX UNI5587</td> <td>8</td> <td>PZ</td> </tr> <tr> <td>VI1220A1</td> <td>VITE AUTOFILETTA NTE 4.2X11 TCS+ MARUTE</td> <td>16</td> <td>PZ</td> </tr> </tbody> </table>	Codice	Descrizione	Qtà	UM	ED1246A0	ETICHETTA SUPERFICI CALDE	1	PZ	ED1271A0	ETICHETTA PERICOLO CADUTA LIQUIDI	1	PZ	EL1020A0	RACCORDO INTERMEDIO "T" TUBO Ø8	2	PZ	EL1020A1	RACCORDO INTERMEDIO "T" TUBO D8 J	2	PZ	EL1180A0	RACCORDO NON RITORNO Ø8 Ø8 FEMMIN	2	PZ	GN1508A0	GUARNIZIONE O-RING COD 2400	2	PZ	RC1008A0	FASCETTA ELASTICA D9 ZINCATA	7	PZ	RC1055A0	FASCETTA STRINGI TUBO Ø25-40 H12 INOX	10	PZ	RC1297A0	RACCORDO A T Ø10	1	PZ	RC1297A1	RACCORDO A T Ø10	1	PZ	RC1360A0	RACCORDO GOMITO JG 10-10	1	PZ	RC1376A0	RACCORDO Y Ø6	1	PZ	TB1177A0	PIEDE QUADRO 40X40 H58 SOVRAP. LM	4	PZ	TB1520A0	TUBO D.INT=30 SP=4 GOMMA EPDM NERO	2.700	M	TB1815A0	TUBO PE 7,93X4,75 TRASPARENT	2	M	TB2243A0	TUBO PET Ø10	1.500	M	VI1075A0	DADO M4 H=4 INOX UNI5587	8	PZ	VI1220A1	VITE AUTOFILETTA NTE 4.2X11 TCS+ MARUTE	16	PZ
Codice	Descrizione	Qtà	UM																																																																														
ED1246A0	ETICHETTA SUPERFICI CALDE	1	PZ																																																																														
ED1271A0	ETICHETTA PERICOLO CADUTA LIQUIDI	1	PZ																																																																														
EL1020A0	RACCORDO INTERMEDIO "T" TUBO Ø8	2	PZ																																																																														
EL1020A1	RACCORDO INTERMEDIO "T" TUBO D8 J	2	PZ																																																																														
EL1180A0	RACCORDO NON RITORNO Ø8 Ø8 FEMMIN	2	PZ																																																																														
GN1508A0	GUARNIZIONE O-RING COD 2400	2	PZ																																																																														
RC1008A0	FASCETTA ELASTICA D9 ZINCATA	7	PZ																																																																														
RC1055A0	FASCETTA STRINGI TUBO Ø25-40 H12 INOX	10	PZ																																																																														
RC1297A0	RACCORDO A T Ø10	1	PZ																																																																														
RC1297A1	RACCORDO A T Ø10	1	PZ																																																																														
RC1360A0	RACCORDO GOMITO JG 10-10	1	PZ																																																																														
RC1376A0	RACCORDO Y Ø6	1	PZ																																																																														
TB1177A0	PIEDE QUADRO 40X40 H58 SOVRAP. LM	4	PZ																																																																														
TB1520A0	TUBO D.INT=30 SP=4 GOMMA EPDM NERO	2.700	M																																																																														
TB1815A0	TUBO PE 7,93X4,75 TRASPARENT	2	M																																																																														
TB2243A0	TUBO PET Ø10	1.500	M																																																																														
VI1075A0	DADO M4 H=4 INOX UNI5587	8	PZ																																																																														
VI1220A1	VITE AUTOFILETTA NTE 4.2X11 TCS+ MARUTE	16	PZ																																																																														

COMPONENTE			RICAMBIO																																																		
Codice	Descrizione	Immagine	Codice	Descrizione	Lista componenti																																																
VL1005A	VASCA SIFONE		XC648	KIT SOVRAPPOSIZIONE LM TOP 800	<table border="1"> <thead> <tr> <th>Codice</th> <th>Descrizione</th> <th>Qtà</th> <th>UM</th> </tr> </thead> <tbody> <tr> <td>VI1895A0</td> <td>DADO CIECO M4 INOX DIN 917</td> <td>8</td> <td>PZ</td> </tr> <tr> <td>VI1945A0</td> <td>VITE M4X20 TCB+ INOX</td> <td>8</td> <td>PZ</td> </tr> <tr> <td>VI1950A0</td> <td>VITE AUTOFORANT E 4,2X13 TCB INOX</td> <td>10</td> <td>PZ</td> </tr> <tr> <td>VL1005A1</td> <td>VASCA SIFON</td> <td>2</td> <td>PZ</td> </tr> <tr> <td>VL1006A0</td> <td>COPERCHIO SIFONE</td> <td>2</td> <td>PZ</td> </tr> <tr> <td>VL1046A1</td> <td>PORTAGOMM A D6-CODOLO D6</td> <td>7</td> <td>PZ</td> </tr> <tr> <td>VL1047A1</td> <td>PORTAGOMM A D6 CODOLO D8</td> <td>2</td> <td>PZ</td> </tr> <tr> <td>VL1047A2</td> <td>PORTAGOMM A D6 CODOLO D8</td> <td>2</td> <td>PZ</td> </tr> <tr> <td>VM1015A1</td> <td>CURVA A 90° INOX Ø30X1</td> <td>1</td> <td>PZ</td> </tr> <tr> <td>VM1794A0</td> <td>FASCETTA 250X4.8 PA66 NERA</td> <td>2</td> <td>PZ</td> </tr> <tr> <td>VM2035A0</td> <td>SUPPORTO PER TUBO DI SCARICO</td> <td>1</td> <td>PZ</td> </tr> </tbody> </table>	Codice	Descrizione	Qtà	UM	VI1895A0	DADO CIECO M4 INOX DIN 917	8	PZ	VI1945A0	VITE M4X20 TCB+ INOX	8	PZ	VI1950A0	VITE AUTOFORANT E 4,2X13 TCB INOX	10	PZ	VL1005A1	VASCA SIFON	2	PZ	VL1006A0	COPERCHIO SIFONE	2	PZ	VL1046A1	PORTAGOMM A D6-CODOLO D6	7	PZ	VL1047A1	PORTAGOMM A D6 CODOLO D8	2	PZ	VL1047A2	PORTAGOMM A D6 CODOLO D8	2	PZ	VM1015A1	CURVA A 90° INOX Ø30X1	1	PZ	VM1794A0	FASCETTA 250X4.8 PA66 NERA	2	PZ	VM2035A0	SUPPORTO PER TUBO DI SCARICO	1	PZ
			Codice	Descrizione	Qtà	UM																																															
VI1895A0	DADO CIECO M4 INOX DIN 917	8	PZ																																																		
VI1945A0	VITE M4X20 TCB+ INOX	8	PZ																																																		
VI1950A0	VITE AUTOFORANT E 4,2X13 TCB INOX	10	PZ																																																		
VL1005A1	VASCA SIFON	2	PZ																																																		
VL1006A0	COPERCHIO SIFONE	2	PZ																																																		
VL1046A1	PORTAGOMM A D6-CODOLO D6	7	PZ																																																		
VL1047A1	PORTAGOMM A D6 CODOLO D8	2	PZ																																																		
VL1047A2	PORTAGOMM A D6 CODOLO D8	2	PZ																																																		
VM1015A1	CURVA A 90° INOX Ø30X1	1	PZ																																																		
VM1794A0	FASCETTA 250X4.8 PA66 NERA	2	PZ																																																		
VM2035A0	SUPPORTO PER TUBO DI SCARICO	1	PZ																																																		
KVL1005A	KIT SIFONE COMPLETO S. 5 / 5E	<table border="1"> <thead> <tr> <th>Codice</th> <th>Descrizione</th> <th>Qtà</th> <th>UM</th> </tr> </thead> <tbody> <tr> <td>GN1508A0</td> <td>GUARNIZIONE O-RING COD 2400</td> <td>1</td> <td>PZ</td> </tr> <tr> <td>VI1075A0</td> <td>DADO M4 H=4 INOX UNI5587</td> <td>4</td> <td>PZ</td> </tr> <tr> <td>VI1895A0</td> <td>DADO CIECO M4 INOX DIN 917</td> <td>4</td> <td>PZ</td> </tr> <tr> <td>VI1945A0</td> <td>VITE M4X20 TCB+ INOX</td> <td>4</td> <td>PZ</td> </tr> <tr> <td>VL1005A1</td> <td>VASCA SIFON</td> <td>1</td> <td>PZ</td> </tr> <tr> <td>VL1006A0</td> <td>COPERCHIO SIFONE</td> <td>1</td> <td>PZ</td> </tr> </tbody> </table>	Codice	Descrizione	Qtà	UM	GN1508A0	GUARNIZIONE O-RING COD 2400	1	PZ	VI1075A0	DADO M4 H=4 INOX UNI5587	4	PZ	VI1895A0	DADO CIECO M4 INOX DIN 917	4	PZ	VI1945A0	VITE M4X20 TCB+ INOX	4	PZ	VL1005A1	VASCA SIFON	1	PZ	VL1006A0	COPERCHIO SIFONE	1	PZ																							
Codice	Descrizione	Qtà	UM																																																		
GN1508A0	GUARNIZIONE O-RING COD 2400	1	PZ																																																		
VI1075A0	DADO M4 H=4 INOX UNI5587	4	PZ																																																		
VI1895A0	DADO CIECO M4 INOX DIN 917	4	PZ																																																		
VI1945A0	VITE M4X20 TCB+ INOX	4	PZ																																																		
VL1005A1	VASCA SIFON	1	PZ																																																		
VL1006A0	COPERCHIO SIFONE	1	PZ																																																		
VL1006A	COPERCHIO SIFON		XUC001	KIT PRIMA INSTALLAZIONE	<table border="1"> <thead> <tr> <th>Codice</th> <th>Descrizione</th> <th>Qtà</th> <th>UM</th> </tr> </thead> <tbody> <tr> <td>0H6567A0</td> <td>LAMIERA SOSTEGNO SIFONE</td> <td>1</td> <td>PZ</td> </tr> <tr> <td>GN1508A0</td> <td>GUARNIZIONE O-RING COD 2400</td> <td>1</td> <td>PZ</td> </tr> <tr> <td>IL1115A0</td> <td>PALETTA LEGNO EPAL 1200X800X130</td> <td>0.100</td> <td>PZ</td> </tr> </tbody> </table>	Codice	Descrizione	Qtà	UM	0H6567A0	LAMIERA SOSTEGNO SIFONE	1	PZ	GN1508A0	GUARNIZIONE O-RING COD 2400	1	PZ	IL1115A0	PALETTA LEGNO EPAL 1200X800X130	0.100	PZ																																
Codice	Descrizione	Qtà	UM																																																		
0H6567A0	LAMIERA SOSTEGNO SIFONE	1	PZ																																																		
GN1508A0	GUARNIZIONE O-RING COD 2400	1	PZ																																																		
IL1115A0	PALETTA LEGNO EPAL 1200X800X130	0.100	PZ																																																		

COMPONENTE			RICAMBIO																																																																													
Codice	Descrizione	Immagine	Codice	Descrizione	Lista componenti																																																																											
VL1006A	COPERCHIO SIFON		XUC001	KIT PRIMA INSTALLAZIONE	<table border="1"> <thead> <tr> <th>Codice</th> <th>Descrizione</th> <th>Qtà</th> <th>UM</th> </tr> </thead> <tbody> <tr> <td>RC1055A0</td> <td>FASCETTA STRINGI TUBO Ø25-40 H12 INOX</td> <td>3</td> <td>PZ</td> </tr> <tr> <td>TB1520A0</td> <td>TUBO D.INT=30 SP=4 GOMMA EPDM NERO</td> <td>2.500</td> <td>M</td> </tr> <tr> <td>TB3207A0</td> <td>TUBO D.50 PROLUNGA CAMINO S.C</td> <td>1</td> <td>PZ</td> </tr> <tr> <td>VI1075A0</td> <td>DADO M4 H=4 INOX UNI5587</td> <td>4</td> <td>PZ</td> </tr> <tr> <td>VI1220A1</td> <td>VITE AUTOFILETTA NTE 4.2X11 TCS+ MARUTE</td> <td>2</td> <td>PZ</td> </tr> <tr> <td>VI1895A0</td> <td>DADO CIECO M4 INOX DIN 917</td> <td>4</td> <td>PZ</td> </tr> <tr> <td>VI1945A0</td> <td>VITE M4X20 TCB+ INOX</td> <td>4</td> <td>PZ</td> </tr> <tr> <td>VI1950A0</td> <td>VITE AUTOFORANT E 4,2X13 TCB INOX</td> <td>2</td> <td>PZ</td> </tr> <tr> <td>VL1005A1</td> <td>VASCA SIFON</td> <td>1</td> <td>PZ</td> </tr> <tr> <td>VL1006A0</td> <td>COPERCHIO SIFONE</td> <td>1</td> <td>PZ</td> </tr> <tr> <td>VM1015A1</td> <td>CURVA A 90° INOX Ø30X1</td> <td>1</td> <td>PZ</td> </tr> </tbody> </table>	Codice	Descrizione	Qtà	UM	RC1055A0	FASCETTA STRINGI TUBO Ø25-40 H12 INOX	3	PZ	TB1520A0	TUBO D.INT=30 SP=4 GOMMA EPDM NERO	2.500	M	TB3207A0	TUBO D.50 PROLUNGA CAMINO S.C	1	PZ	VI1075A0	DADO M4 H=4 INOX UNI5587	4	PZ	VI1220A1	VITE AUTOFILETTA NTE 4.2X11 TCS+ MARUTE	2	PZ	VI1895A0	DADO CIECO M4 INOX DIN 917	4	PZ	VI1945A0	VITE M4X20 TCB+ INOX	4	PZ	VI1950A0	VITE AUTOFORANT E 4,2X13 TCB INOX	2	PZ	VL1005A1	VASCA SIFON	1	PZ	VL1006A0	COPERCHIO SIFONE	1	PZ	VM1015A1	CURVA A 90° INOX Ø30X1	1	PZ	XC761	KIT SOVRAPPOSIZIONE 3 FORNI LM XFT200	<table border="1"> <thead> <tr> <th>Codice</th> <th>Descrizione</th> <th>Qtà</th> <th>UM</th> </tr> </thead> <tbody> <tr> <td>0H1237A0</td> <td>SUPPORTO SIFONE LM TO</td> <td>3</td> <td>PZ</td> </tr> <tr> <td>0H7082A0</td> <td>PROFILO FRONTALE KIT SOVRAP.LM 800 XC64</td> <td>2</td> <td>PZ</td> </tr> <tr> <td>0H7083A0</td> <td>PROFILO POSTERIORE KIT SOVRAP.LM 800 XC</td> <td>4</td> <td>PZ</td> </tr> <tr> <td>0H7084A0</td> <td>PROFILO FRONTALE KIT SOVRAP.LM60 0 XC651</td> <td>2</td> <td>PZ</td> </tr> <tr> <td>0H7085A0</td> <td>PROFILO POSTERIORE KIT SOVRAP.LM 600 XC</td> <td>4</td> <td>PZ</td> </tr> </tbody> </table>	Codice	Descrizione	Qtà	UM	0H1237A0	SUPPORTO SIFONE LM TO	3	PZ	0H7082A0	PROFILO FRONTALE KIT SOVRAP.LM 800 XC64	2	PZ	0H7083A0	PROFILO POSTERIORE KIT SOVRAP.LM 800 XC	4	PZ	0H7084A0	PROFILO FRONTALE KIT SOVRAP.LM60 0 XC651	2	PZ	0H7085A0	PROFILO POSTERIORE KIT SOVRAP.LM 600 XC	4	PZ
			Codice	Descrizione	Qtà	UM																																																																										
RC1055A0	FASCETTA STRINGI TUBO Ø25-40 H12 INOX	3	PZ																																																																													
TB1520A0	TUBO D.INT=30 SP=4 GOMMA EPDM NERO	2.500	M																																																																													
TB3207A0	TUBO D.50 PROLUNGA CAMINO S.C	1	PZ																																																																													
VI1075A0	DADO M4 H=4 INOX UNI5587	4	PZ																																																																													
VI1220A1	VITE AUTOFILETTA NTE 4.2X11 TCS+ MARUTE	2	PZ																																																																													
VI1895A0	DADO CIECO M4 INOX DIN 917	4	PZ																																																																													
VI1945A0	VITE M4X20 TCB+ INOX	4	PZ																																																																													
VI1950A0	VITE AUTOFORANT E 4,2X13 TCB INOX	2	PZ																																																																													
VL1005A1	VASCA SIFON	1	PZ																																																																													
VL1006A0	COPERCHIO SIFONE	1	PZ																																																																													
VM1015A1	CURVA A 90° INOX Ø30X1	1	PZ																																																																													
Codice	Descrizione	Qtà	UM																																																																													
0H1237A0	SUPPORTO SIFONE LM TO	3	PZ																																																																													
0H7082A0	PROFILO FRONTALE KIT SOVRAP.LM 800 XC64	2	PZ																																																																													
0H7083A0	PROFILO POSTERIORE KIT SOVRAP.LM 800 XC	4	PZ																																																																													
0H7084A0	PROFILO FRONTALE KIT SOVRAP.LM60 0 XC651	2	PZ																																																																													
0H7085A0	PROFILO POSTERIORE KIT SOVRAP.LM 600 XC	4	PZ																																																																													

COMPONENTE			RICAMBIO																																																																																		
Codice	Descrizione	Immagine	Codice	Descrizione	Lista componenti																																																																																
VL1006A	COPERCHIO SIFON		XC761	KIT SOVRAPPOSIZIONE 3 FORNI LM XFT200	<table border="1"> <thead> <tr> <th>Codice</th> <th>Descrizione</th> <th>Qtà</th> <th>UM</th> </tr> </thead> <tbody> <tr> <td>ED1246A0</td> <td>ETICHETTA SUPERFICI CALDE</td> <td>1</td> <td>PZ</td> </tr> <tr> <td>ED1271A0</td> <td>ETICHETTA PERICOLO CADUTA LIQUIDI</td> <td>1</td> <td>PZ</td> </tr> <tr> <td>EL1020A0</td> <td>RACCORDO INTERMEDIO "T" TUBO Ø8</td> <td>4</td> <td>PZ</td> </tr> <tr> <td>EL1020A1</td> <td>RACCORDO INTERMEDIO "T" TUBO D8 J</td> <td>4</td> <td>PZ</td> </tr> <tr> <td>EL1180A0</td> <td>RACCORDO NON RITORNO Ø8 Ø8 FEMMIN</td> <td>3</td> <td>PZ</td> </tr> <tr> <td>GN1508A0</td> <td>GUARNIZIONE O-RING COD 2400</td> <td>3</td> <td>PZ</td> </tr> <tr> <td>RC1008A0</td> <td>FASCETTA ELASTICA D9 ZINCATA</td> <td>12</td> <td>PZ</td> </tr> <tr> <td>RC1055A0</td> <td>FASCETTA STRINGI TUBO Ø25-40 H12 INOX</td> <td>15</td> <td>PZ</td> </tr> <tr> <td>RC1297A0</td> <td>RACCORDO A T Ø10</td> <td>2</td> <td>PZ</td> </tr> <tr> <td>RC1297A1</td> <td>RACCORDO A T Ø10</td> <td>2</td> <td>PZ</td> </tr> <tr> <td>RC1360A0</td> <td>RACCORDO GOMITO JG 10-10</td> <td>1</td> <td>PZ</td> </tr> <tr> <td>RC1376A0</td> <td>RACCORDO Y Ø6</td> <td>2</td> <td>PZ</td> </tr> <tr> <td>TB1177A0</td> <td>PIEDE QUADRO 40X40 H58 SOVRAP. LM</td> <td>8</td> <td>PZ</td> </tr> <tr> <td>TB1520A0</td> <td>TUBO D.INT=30 SP=4 GOMMA EPDM NERO</td> <td>5</td> <td>M</td> </tr> <tr> <td>TB1815A0</td> <td>TUBO PE 7,93X4,75 TRASPARENT</td> <td>12</td> <td>M</td> </tr> <tr> <td>TB1816A0</td> <td>TUBO PP 6X4 TRASPARENT</td> <td>3</td> <td>M</td> </tr> <tr> <td>TB2243A0</td> <td>TUBO PET Ø10</td> <td>4</td> <td>M</td> </tr> <tr> <td>VI1075A0</td> <td>DADO M4 H=4 INOX UNI5587</td> <td>12</td> <td>PZ</td> </tr> <tr> <td>VI1220A1</td> <td>VITE AUTOFILETTA NTE 4.2X11 TCS+ MARUTE</td> <td>30</td> <td>PZ</td> </tr> </tbody> </table>	Codice	Descrizione	Qtà	UM	ED1246A0	ETICHETTA SUPERFICI CALDE	1	PZ	ED1271A0	ETICHETTA PERICOLO CADUTA LIQUIDI	1	PZ	EL1020A0	RACCORDO INTERMEDIO "T" TUBO Ø8	4	PZ	EL1020A1	RACCORDO INTERMEDIO "T" TUBO D8 J	4	PZ	EL1180A0	RACCORDO NON RITORNO Ø8 Ø8 FEMMIN	3	PZ	GN1508A0	GUARNIZIONE O-RING COD 2400	3	PZ	RC1008A0	FASCETTA ELASTICA D9 ZINCATA	12	PZ	RC1055A0	FASCETTA STRINGI TUBO Ø25-40 H12 INOX	15	PZ	RC1297A0	RACCORDO A T Ø10	2	PZ	RC1297A1	RACCORDO A T Ø10	2	PZ	RC1360A0	RACCORDO GOMITO JG 10-10	1	PZ	RC1376A0	RACCORDO Y Ø6	2	PZ	TB1177A0	PIEDE QUADRO 40X40 H58 SOVRAP. LM	8	PZ	TB1520A0	TUBO D.INT=30 SP=4 GOMMA EPDM NERO	5	M	TB1815A0	TUBO PE 7,93X4,75 TRASPARENT	12	M	TB1816A0	TUBO PP 6X4 TRASPARENT	3	M	TB2243A0	TUBO PET Ø10	4	M	VI1075A0	DADO M4 H=4 INOX UNI5587	12	PZ	VI1220A1	VITE AUTOFILETTA NTE 4.2X11 TCS+ MARUTE	30	PZ
Codice	Descrizione	Qtà	UM																																																																																		
ED1246A0	ETICHETTA SUPERFICI CALDE	1	PZ																																																																																		
ED1271A0	ETICHETTA PERICOLO CADUTA LIQUIDI	1	PZ																																																																																		
EL1020A0	RACCORDO INTERMEDIO "T" TUBO Ø8	4	PZ																																																																																		
EL1020A1	RACCORDO INTERMEDIO "T" TUBO D8 J	4	PZ																																																																																		
EL1180A0	RACCORDO NON RITORNO Ø8 Ø8 FEMMIN	3	PZ																																																																																		
GN1508A0	GUARNIZIONE O-RING COD 2400	3	PZ																																																																																		
RC1008A0	FASCETTA ELASTICA D9 ZINCATA	12	PZ																																																																																		
RC1055A0	FASCETTA STRINGI TUBO Ø25-40 H12 INOX	15	PZ																																																																																		
RC1297A0	RACCORDO A T Ø10	2	PZ																																																																																		
RC1297A1	RACCORDO A T Ø10	2	PZ																																																																																		
RC1360A0	RACCORDO GOMITO JG 10-10	1	PZ																																																																																		
RC1376A0	RACCORDO Y Ø6	2	PZ																																																																																		
TB1177A0	PIEDE QUADRO 40X40 H58 SOVRAP. LM	8	PZ																																																																																		
TB1520A0	TUBO D.INT=30 SP=4 GOMMA EPDM NERO	5	M																																																																																		
TB1815A0	TUBO PE 7,93X4,75 TRASPARENT	12	M																																																																																		
TB1816A0	TUBO PP 6X4 TRASPARENT	3	M																																																																																		
TB2243A0	TUBO PET Ø10	4	M																																																																																		
VI1075A0	DADO M4 H=4 INOX UNI5587	12	PZ																																																																																		
VI1220A1	VITE AUTOFILETTA NTE 4.2X11 TCS+ MARUTE	30	PZ																																																																																		

COMPONENTE			RICAMBIO																																										
Codice	Descrizione	Immagine	Codice	Descrizione	Lista componenti																																								
VL1006A	COPERCHIO SIFON		XC761	KIT SOVRAPPOSIZIONE 3 FORNI LM XFT200	<table border="1"> <thead> <tr> <th>Codice</th> <th>Descrizione</th> <th>Qtà</th> <th>UM</th> </tr> </thead> <tbody> <tr> <td>VI1895A0</td> <td>DADO CIECO M4 INOX DIN 917</td> <td>12</td> <td>PZ</td> </tr> <tr> <td>VI1945A0</td> <td>VITE M4X20 TCB+ INOX</td> <td>12</td> <td>PZ</td> </tr> <tr> <td>VI1950A0</td> <td>VITE AUTOFORANT E 4,2X13 TCB INOX</td> <td>20</td> <td>PZ</td> </tr> <tr> <td>VL1005A1</td> <td>VASCA SIFON</td> <td>3</td> <td>PZ</td> </tr> <tr> <td>VL1006A0</td> <td>COPERCHIO SIFONE</td> <td>3</td> <td>PZ</td> </tr> <tr> <td>VL1046A1</td> <td>PORTAGOMM A D6-CODOLO D6</td> <td>12</td> <td>PZ</td> </tr> <tr> <td>VM1015A1</td> <td>CURVA A 90° INOX Ø30X1</td> <td>1</td> <td>PZ</td> </tr> <tr> <td>VM1794A0</td> <td>FASCETTA 250X4.8 PA66 NERA</td> <td>3</td> <td>PZ</td> </tr> <tr> <td>VM2035A0</td> <td>SUPPORTO PER TUBO DI SCARICO</td> <td>3</td> <td>PZ</td> </tr> </tbody> </table>	Codice	Descrizione	Qtà	UM	VI1895A0	DADO CIECO M4 INOX DIN 917	12	PZ	VI1945A0	VITE M4X20 TCB+ INOX	12	PZ	VI1950A0	VITE AUTOFORANT E 4,2X13 TCB INOX	20	PZ	VL1005A1	VASCA SIFON	3	PZ	VL1006A0	COPERCHIO SIFONE	3	PZ	VL1046A1	PORTAGOMM A D6-CODOLO D6	12	PZ	VM1015A1	CURVA A 90° INOX Ø30X1	1	PZ	VM1794A0	FASCETTA 250X4.8 PA66 NERA	3	PZ	VM2035A0	SUPPORTO PER TUBO DI SCARICO	3	PZ
Codice	Descrizione	Qtà	UM																																										
VI1895A0	DADO CIECO M4 INOX DIN 917	12	PZ																																										
VI1945A0	VITE M4X20 TCB+ INOX	12	PZ																																										
VI1950A0	VITE AUTOFORANT E 4,2X13 TCB INOX	20	PZ																																										
VL1005A1	VASCA SIFON	3	PZ																																										
VL1006A0	COPERCHIO SIFONE	3	PZ																																										
VL1046A1	PORTAGOMM A D6-CODOLO D6	12	PZ																																										
VM1015A1	CURVA A 90° INOX Ø30X1	1	PZ																																										
VM1794A0	FASCETTA 250X4.8 PA66 NERA	3	PZ																																										
VM2035A0	SUPPORTO PER TUBO DI SCARICO	3	PZ																																										
			XC757	KIT SOVRAPPOSIZIONE CT 1/1 S.5E	<table border="1"> <thead> <tr> <th>Codice</th> <th>Descrizione</th> <th>Qtà</th> <th>UM</th> </tr> </thead> <tbody> <tr> <td>0H6463A0</td> <td>PROFILO FRONTALE PER XC757</td> <td>1</td> <td>PZ</td> </tr> <tr> <td>CE1305A0</td> <td>CAVO RJ45 - RJ45 L=2MT</td> <td>1</td> <td>PZ</td> </tr> <tr> <td>ED1246A0</td> <td>ETICHETTA SUPERFICI CALDE</td> <td>2</td> <td>PZ</td> </tr> <tr> <td>ED1271A0</td> <td>ETICHETTA PERICOLO CADUTA LIQUIDI</td> <td>1</td> <td>PZ</td> </tr> <tr> <td>EL1020A0</td> <td>RACCORDO INTERMEDIO "T" TUBO Ø8</td> <td>2</td> <td>PZ</td> </tr> <tr> <td>EL1020A1</td> <td>RACCORDO INTERMEDIO "T" TUBO D8 J</td> <td>2</td> <td>PZ</td> </tr> <tr> <td>GN1508A0</td> <td>GUARNIZIONE O-RING COD 2400</td> <td>2</td> <td>PZ</td> </tr> <tr> <td>PD1069A0</td> <td>PIEDE SOVRAPPOSIZ IONE CT-BT S5-E</td> <td>1</td> <td>PZ</td> </tr> <tr> <td>RC1008A0</td> <td>FASCETTA ELASTICA D9 ZINCATA</td> <td>3</td> <td>PZ</td> </tr> </tbody> </table>	Codice	Descrizione	Qtà	UM	0H6463A0	PROFILO FRONTALE PER XC757	1	PZ	CE1305A0	CAVO RJ45 - RJ45 L=2MT	1	PZ	ED1246A0	ETICHETTA SUPERFICI CALDE	2	PZ	ED1271A0	ETICHETTA PERICOLO CADUTA LIQUIDI	1	PZ	EL1020A0	RACCORDO INTERMEDIO "T" TUBO Ø8	2	PZ	EL1020A1	RACCORDO INTERMEDIO "T" TUBO D8 J	2	PZ	GN1508A0	GUARNIZIONE O-RING COD 2400	2	PZ	PD1069A0	PIEDE SOVRAPPOSIZ IONE CT-BT S5-E	1	PZ	RC1008A0	FASCETTA ELASTICA D9 ZINCATA	3	PZ
Codice	Descrizione	Qtà	UM																																										
0H6463A0	PROFILO FRONTALE PER XC757	1	PZ																																										
CE1305A0	CAVO RJ45 - RJ45 L=2MT	1	PZ																																										
ED1246A0	ETICHETTA SUPERFICI CALDE	2	PZ																																										
ED1271A0	ETICHETTA PERICOLO CADUTA LIQUIDI	1	PZ																																										
EL1020A0	RACCORDO INTERMEDIO "T" TUBO Ø8	2	PZ																																										
EL1020A1	RACCORDO INTERMEDIO "T" TUBO D8 J	2	PZ																																										
GN1508A0	GUARNIZIONE O-RING COD 2400	2	PZ																																										
PD1069A0	PIEDE SOVRAPPOSIZ IONE CT-BT S5-E	1	PZ																																										
RC1008A0	FASCETTA ELASTICA D9 ZINCATA	3	PZ																																										

COMPONENTE			RICAMBIO																																																																																										
Codice	Descrizione	Immagine	Codice	Descrizione	Lista componenti																																																																																								
VL1006A	COPERCHIO SIFON		XC757	KIT SOVRAPPOSIZIONE CT 1/1 S.5E	<table border="1"> <thead> <tr> <th>Codice</th> <th>Descrizione</th> <th>Qtà</th> <th>UM</th> </tr> </thead> <tbody> <tr> <td>RC1055A0</td> <td>FASCETTA STRINGI TUBO Ø25-40 H12 INOX</td> <td>14</td> <td>PZ</td> </tr> <tr> <td>RC1130A0</td> <td>FASCETTA 130X2,6</td> <td>3</td> <td>PZ</td> </tr> <tr> <td>RC1297A0</td> <td>RACCORDO A T Ø10</td> <td>1</td> <td>PZ</td> </tr> <tr> <td>RC1297A1</td> <td>RACCORDO A T Ø10</td> <td>1</td> <td>PZ</td> </tr> <tr> <td>RC1376A0</td> <td>RACCORDO Y Ø6</td> <td>1</td> <td>PZ</td> </tr> <tr> <td>TB1520A0</td> <td>TUBO D.INT=30 SP=4 GOMMA EPDM NERO</td> <td>5</td> <td>M</td> </tr> <tr> <td>TB1765A1</td> <td>TUBO RACCORDO CAMINO KIT SOVRAP. Ø30X1</td> <td>2</td> <td>PZ</td> </tr> <tr> <td>TB2243A0</td> <td>TUBO PET Ø10</td> <td>1.500</td> <td>M</td> </tr> <tr> <td>VI1075A0</td> <td>DADO M4 H=4 INOX UNI5587</td> <td>8</td> <td>PZ</td> </tr> <tr> <td>VI1220A1</td> <td>VITE AUTOFILETTA NTE 4.2X11 TCS+ MARUTE</td> <td>4</td> <td>PZ</td> </tr> <tr> <td>VI1895A0</td> <td>DADO CIECO M4 INOX DIN 917</td> <td>8</td> <td>PZ</td> </tr> <tr> <td>VI1945A0</td> <td>VITE M4X20 TCB+ INOX</td> <td>8</td> <td>PZ</td> </tr> <tr> <td>VI1950A0</td> <td>VITE AUTOFORANT E 4,2X13 TCB INOX</td> <td>26</td> <td>PZ</td> </tr> <tr> <td>VL1005A1</td> <td>VASCA SIFON</td> <td>2</td> <td>PZ</td> </tr> <tr> <td>VL1006A0</td> <td>COPERCHIO SIFONE</td> <td>2</td> <td>PZ</td> </tr> <tr> <td>VL1043A0</td> <td>PORTAGOMM A D4-CODOLO D6</td> <td>3</td> <td>PZ</td> </tr> <tr> <td>VL1046A1</td> <td>PORTAGOMM A D6-CODOLO D6</td> <td>3</td> <td>PZ</td> </tr> <tr> <td>VM1015A1</td> <td>CURVA A 90° INOX Ø30X1</td> <td>1</td> <td>PZ</td> </tr> <tr> <td>VM1794A0</td> <td>FASCETTA 250X4.8 PA66 NERA</td> <td>3</td> <td>PZ</td> </tr> <tr> <td>VM1987A0</td> <td>STAFFA SOVRAPPOSIZ IONE FORNI</td> <td>1</td> <td>PZ</td> </tr> <tr> <td>VM2035A0</td> <td>SUPPORTO PER TUBO DI SCARICO</td> <td>2</td> <td>PZ</td> </tr> </tbody> </table>	Codice	Descrizione	Qtà	UM	RC1055A0	FASCETTA STRINGI TUBO Ø25-40 H12 INOX	14	PZ	RC1130A0	FASCETTA 130X2,6	3	PZ	RC1297A0	RACCORDO A T Ø10	1	PZ	RC1297A1	RACCORDO A T Ø10	1	PZ	RC1376A0	RACCORDO Y Ø6	1	PZ	TB1520A0	TUBO D.INT=30 SP=4 GOMMA EPDM NERO	5	M	TB1765A1	TUBO RACCORDO CAMINO KIT SOVRAP. Ø30X1	2	PZ	TB2243A0	TUBO PET Ø10	1.500	M	VI1075A0	DADO M4 H=4 INOX UNI5587	8	PZ	VI1220A1	VITE AUTOFILETTA NTE 4.2X11 TCS+ MARUTE	4	PZ	VI1895A0	DADO CIECO M4 INOX DIN 917	8	PZ	VI1945A0	VITE M4X20 TCB+ INOX	8	PZ	VI1950A0	VITE AUTOFORANT E 4,2X13 TCB INOX	26	PZ	VL1005A1	VASCA SIFON	2	PZ	VL1006A0	COPERCHIO SIFONE	2	PZ	VL1043A0	PORTAGOMM A D4-CODOLO D6	3	PZ	VL1046A1	PORTAGOMM A D6-CODOLO D6	3	PZ	VM1015A1	CURVA A 90° INOX Ø30X1	1	PZ	VM1794A0	FASCETTA 250X4.8 PA66 NERA	3	PZ	VM1987A0	STAFFA SOVRAPPOSIZ IONE FORNI	1	PZ	VM2035A0	SUPPORTO PER TUBO DI SCARICO	2	PZ
Codice	Descrizione	Qtà	UM																																																																																										
RC1055A0	FASCETTA STRINGI TUBO Ø25-40 H12 INOX	14	PZ																																																																																										
RC1130A0	FASCETTA 130X2,6	3	PZ																																																																																										
RC1297A0	RACCORDO A T Ø10	1	PZ																																																																																										
RC1297A1	RACCORDO A T Ø10	1	PZ																																																																																										
RC1376A0	RACCORDO Y Ø6	1	PZ																																																																																										
TB1520A0	TUBO D.INT=30 SP=4 GOMMA EPDM NERO	5	M																																																																																										
TB1765A1	TUBO RACCORDO CAMINO KIT SOVRAP. Ø30X1	2	PZ																																																																																										
TB2243A0	TUBO PET Ø10	1.500	M																																																																																										
VI1075A0	DADO M4 H=4 INOX UNI5587	8	PZ																																																																																										
VI1220A1	VITE AUTOFILETTA NTE 4.2X11 TCS+ MARUTE	4	PZ																																																																																										
VI1895A0	DADO CIECO M4 INOX DIN 917	8	PZ																																																																																										
VI1945A0	VITE M4X20 TCB+ INOX	8	PZ																																																																																										
VI1950A0	VITE AUTOFORANT E 4,2X13 TCB INOX	26	PZ																																																																																										
VL1005A1	VASCA SIFON	2	PZ																																																																																										
VL1006A0	COPERCHIO SIFONE	2	PZ																																																																																										
VL1043A0	PORTAGOMM A D4-CODOLO D6	3	PZ																																																																																										
VL1046A1	PORTAGOMM A D6-CODOLO D6	3	PZ																																																																																										
VM1015A1	CURVA A 90° INOX Ø30X1	1	PZ																																																																																										
VM1794A0	FASCETTA 250X4.8 PA66 NERA	3	PZ																																																																																										
VM1987A0	STAFFA SOVRAPPOSIZ IONE FORNI	1	PZ																																																																																										
VM2035A0	SUPPORTO PER TUBO DI SCARICO	2	PZ																																																																																										

COMPONENTE			RICAMBIO																																																																														
Codice	Descrizione	Immagine	Codice	Descrizione	Lista componenti																																																																												
VL1006A	COPERCHIO SIFON		XC756	KIT SOVRAPPOSIZIONE CT 2/3 S.5E	<table border="1"> <thead> <tr> <th>Codice</th> <th>Descrizione</th> <th>Qtà</th> <th>UM</th> </tr> </thead> <tbody> <tr> <td>0H6462A0</td> <td>PROFILO FRONTALE PER XC756</td> <td>1</td> <td>PZ</td> </tr> <tr> <td>CE1305A0</td> <td>CAVO RJ45 - RJ45 L=2MT</td> <td>1</td> <td>PZ</td> </tr> <tr> <td>ED1246A0</td> <td>ETICHETTA SUPERFICI CALDE</td> <td>1</td> <td>PZ</td> </tr> <tr> <td>ED1271A0</td> <td>ETICHETTA PERICOLO CADUTA LIQUIDI</td> <td>1</td> <td>PZ</td> </tr> <tr> <td>EL1020A0</td> <td>RACCORDO INTERMEDIO "T" TUBO Ø8</td> <td>2</td> <td>PZ</td> </tr> <tr> <td>EL1020A1</td> <td>RACCORDO INTERMEDIO "T" TUBO D8 J</td> <td>2</td> <td>PZ</td> </tr> <tr> <td>GN1508A0</td> <td>GUARNIZIONE O-RING COD 2400</td> <td>2</td> <td>PZ</td> </tr> <tr> <td>PD1069A0</td> <td>PIEDE SOVRAPPOSIZIONE CT-BT S5-E</td> <td>1</td> <td>PZ</td> </tr> <tr> <td>RC1008A0</td> <td>FASCETTA ELASTICA D9 ZINCATA</td> <td>3</td> <td>PZ</td> </tr> <tr> <td>RC1055A0</td> <td>FASCETTA STRINGI TUBO Ø25-40 H12 INOX</td> <td>14</td> <td>PZ</td> </tr> <tr> <td>RC1130A0</td> <td>FASCETTA 130X2,6</td> <td>3</td> <td>PZ</td> </tr> <tr> <td>RC1297A0</td> <td>RACCORDO A T Ø10</td> <td>1</td> <td>PZ</td> </tr> <tr> <td>RC1297A1</td> <td>RACCORDO A T Ø10</td> <td>1</td> <td>PZ</td> </tr> <tr> <td>RC1376A0</td> <td>RACCORDO Y Ø6</td> <td>1</td> <td>PZ</td> </tr> <tr> <td>TB1520A0</td> <td>TUBO D.INT=30 SP=4 GOMMA EPDM NERO</td> <td>3</td> <td>M</td> </tr> <tr> <td>TB1765A1</td> <td>TUBO RACCORDO CAMINO KIT SOVRAP. Ø30X1</td> <td>1</td> <td>PZ</td> </tr> <tr> <td>TB2243A0</td> <td>TUBO PET Ø10 1.500</td> <td>1.500</td> <td>M</td> </tr> <tr> <td>VI1075A0</td> <td>DADO M4 H=4 INOX UNI5587</td> <td>8</td> <td>PZ</td> </tr> </tbody> </table>	Codice	Descrizione	Qtà	UM	0H6462A0	PROFILO FRONTALE PER XC756	1	PZ	CE1305A0	CAVO RJ45 - RJ45 L=2MT	1	PZ	ED1246A0	ETICHETTA SUPERFICI CALDE	1	PZ	ED1271A0	ETICHETTA PERICOLO CADUTA LIQUIDI	1	PZ	EL1020A0	RACCORDO INTERMEDIO "T" TUBO Ø8	2	PZ	EL1020A1	RACCORDO INTERMEDIO "T" TUBO D8 J	2	PZ	GN1508A0	GUARNIZIONE O-RING COD 2400	2	PZ	PD1069A0	PIEDE SOVRAPPOSIZIONE CT-BT S5-E	1	PZ	RC1008A0	FASCETTA ELASTICA D9 ZINCATA	3	PZ	RC1055A0	FASCETTA STRINGI TUBO Ø25-40 H12 INOX	14	PZ	RC1130A0	FASCETTA 130X2,6	3	PZ	RC1297A0	RACCORDO A T Ø10	1	PZ	RC1297A1	RACCORDO A T Ø10	1	PZ	RC1376A0	RACCORDO Y Ø6	1	PZ	TB1520A0	TUBO D.INT=30 SP=4 GOMMA EPDM NERO	3	M	TB1765A1	TUBO RACCORDO CAMINO KIT SOVRAP. Ø30X1	1	PZ	TB2243A0	TUBO PET Ø10 1.500	1.500	M	VI1075A0	DADO M4 H=4 INOX UNI5587	8	PZ
Codice	Descrizione	Qtà	UM																																																																														
0H6462A0	PROFILO FRONTALE PER XC756	1	PZ																																																																														
CE1305A0	CAVO RJ45 - RJ45 L=2MT	1	PZ																																																																														
ED1246A0	ETICHETTA SUPERFICI CALDE	1	PZ																																																																														
ED1271A0	ETICHETTA PERICOLO CADUTA LIQUIDI	1	PZ																																																																														
EL1020A0	RACCORDO INTERMEDIO "T" TUBO Ø8	2	PZ																																																																														
EL1020A1	RACCORDO INTERMEDIO "T" TUBO D8 J	2	PZ																																																																														
GN1508A0	GUARNIZIONE O-RING COD 2400	2	PZ																																																																														
PD1069A0	PIEDE SOVRAPPOSIZIONE CT-BT S5-E	1	PZ																																																																														
RC1008A0	FASCETTA ELASTICA D9 ZINCATA	3	PZ																																																																														
RC1055A0	FASCETTA STRINGI TUBO Ø25-40 H12 INOX	14	PZ																																																																														
RC1130A0	FASCETTA 130X2,6	3	PZ																																																																														
RC1297A0	RACCORDO A T Ø10	1	PZ																																																																														
RC1297A1	RACCORDO A T Ø10	1	PZ																																																																														
RC1376A0	RACCORDO Y Ø6	1	PZ																																																																														
TB1520A0	TUBO D.INT=30 SP=4 GOMMA EPDM NERO	3	M																																																																														
TB1765A1	TUBO RACCORDO CAMINO KIT SOVRAP. Ø30X1	1	PZ																																																																														
TB2243A0	TUBO PET Ø10 1.500	1.500	M																																																																														
VI1075A0	DADO M4 H=4 INOX UNI5587	8	PZ																																																																														

COMPONENTE			RICAMBIO																																																						
Codice	Descrizione	Immagine	Codice	Descrizione	Lista componenti																																																				
VL1006A	COPERCHIO SIFON		XC756	KIT SOVRAPPOSIZIONE CT 2/3 S.5E	<table border="1"> <thead> <tr> <th>Codice</th> <th>Descrizione</th> <th>Qtà</th> <th>UM</th> </tr> </thead> <tbody> <tr> <td>VI1220A1</td> <td>VITE AUTOFILETTA NTE 4.2X11 TCS+ MARUTE</td> <td>4</td> <td>PZ</td> </tr> <tr> <td>VI1895A0</td> <td>DADO CIECO M4 INOX DIN 917</td> <td>8</td> <td>PZ</td> </tr> <tr> <td>VI1945A0</td> <td>VITE M4X20 TCB+ INOX</td> <td>8</td> <td>PZ</td> </tr> <tr> <td>VI1950A0</td> <td>VITE AUTOFORANT E 4,2X13 TCB INOX</td> <td>26</td> <td>PZ</td> </tr> <tr> <td>VL1005A1</td> <td>VASCA SIFON</td> <td>2</td> <td>PZ</td> </tr> <tr> <td>VL1006A0</td> <td>COPERCHIO SIFONE</td> <td>2</td> <td>PZ</td> </tr> <tr> <td>VL1043A0</td> <td>PORTAGOMM A D4-CODOLO D6</td> <td>3</td> <td>PZ</td> </tr> <tr> <td>VL1046A1</td> <td>PORTAGOMM A D6-CODOLO D6</td> <td>3</td> <td>PZ</td> </tr> <tr> <td>VM1015A1</td> <td>CURVA A 90° INOX Ø30X1</td> <td>1</td> <td>PZ</td> </tr> <tr> <td>VM1794A0</td> <td>FASCETTA 250X4.8 PA66 NERA</td> <td>3</td> <td>PZ</td> </tr> <tr> <td>VM1987A0</td> <td>STAFFA SOVRAPPOSIZ IONE FORNI</td> <td>1</td> <td>PZ</td> </tr> <tr> <td>VM2035A0</td> <td>SUPPORTO PER TUBO DI SCARICO</td> <td>1</td> <td>PZ</td> </tr> </tbody> </table>	Codice	Descrizione	Qtà	UM	VI1220A1	VITE AUTOFILETTA NTE 4.2X11 TCS+ MARUTE	4	PZ	VI1895A0	DADO CIECO M4 INOX DIN 917	8	PZ	VI1945A0	VITE M4X20 TCB+ INOX	8	PZ	VI1950A0	VITE AUTOFORANT E 4,2X13 TCB INOX	26	PZ	VL1005A1	VASCA SIFON	2	PZ	VL1006A0	COPERCHIO SIFONE	2	PZ	VL1043A0	PORTAGOMM A D4-CODOLO D6	3	PZ	VL1046A1	PORTAGOMM A D6-CODOLO D6	3	PZ	VM1015A1	CURVA A 90° INOX Ø30X1	1	PZ	VM1794A0	FASCETTA 250X4.8 PA66 NERA	3	PZ	VM1987A0	STAFFA SOVRAPPOSIZ IONE FORNI	1	PZ	VM2035A0	SUPPORTO PER TUBO DI SCARICO	1	PZ
Codice	Descrizione	Qtà	UM																																																						
VI1220A1	VITE AUTOFILETTA NTE 4.2X11 TCS+ MARUTE	4	PZ																																																						
VI1895A0	DADO CIECO M4 INOX DIN 917	8	PZ																																																						
VI1945A0	VITE M4X20 TCB+ INOX	8	PZ																																																						
VI1950A0	VITE AUTOFORANT E 4,2X13 TCB INOX	26	PZ																																																						
VL1005A1	VASCA SIFON	2	PZ																																																						
VL1006A0	COPERCHIO SIFONE	2	PZ																																																						
VL1043A0	PORTAGOMM A D4-CODOLO D6	3	PZ																																																						
VL1046A1	PORTAGOMM A D6-CODOLO D6	3	PZ																																																						
VM1015A1	CURVA A 90° INOX Ø30X1	1	PZ																																																						
VM1794A0	FASCETTA 250X4.8 PA66 NERA	3	PZ																																																						
VM1987A0	STAFFA SOVRAPPOSIZ IONE FORNI	1	PZ																																																						
VM2035A0	SUPPORTO PER TUBO DI SCARICO	1	PZ																																																						
			XC755	KIT SOVRAPPOSIZIONE BT-CT 2/1 S.5E	<table border="1"> <thead> <tr> <th>Codice</th> <th>Descrizione</th> <th>Qtà</th> <th>UM</th> </tr> </thead> <tbody> <tr> <td>0H6461A0</td> <td>PROFILO FRONTALE PER XC755</td> <td>1</td> <td>PZ</td> </tr> <tr> <td>CE1635A0</td> <td>CAVO RJ45 - RJ45 L=3MT</td> <td>1</td> <td>PZ</td> </tr> <tr> <td>ED1246A0</td> <td>ETICHETTA SUPERFICI CALDE</td> <td>2</td> <td>PZ</td> </tr> <tr> <td>ED1271A0</td> <td>ETICHETTA PERICOLO CADUTA LIQUIDI</td> <td>1</td> <td>PZ</td> </tr> <tr> <td>EL1020A0</td> <td>RACCORDO INTERMEDIO "T" TUBO Ø8</td> <td>2</td> <td>PZ</td> </tr> <tr> <td>EL1020A1</td> <td>RACCORDO INTERMEDIO "T" TUBO D8 J</td> <td>2</td> <td>PZ</td> </tr> </tbody> </table>	Codice	Descrizione	Qtà	UM	0H6461A0	PROFILO FRONTALE PER XC755	1	PZ	CE1635A0	CAVO RJ45 - RJ45 L=3MT	1	PZ	ED1246A0	ETICHETTA SUPERFICI CALDE	2	PZ	ED1271A0	ETICHETTA PERICOLO CADUTA LIQUIDI	1	PZ	EL1020A0	RACCORDO INTERMEDIO "T" TUBO Ø8	2	PZ	EL1020A1	RACCORDO INTERMEDIO "T" TUBO D8 J	2	PZ																								
Codice	Descrizione	Qtà	UM																																																						
0H6461A0	PROFILO FRONTALE PER XC755	1	PZ																																																						
CE1635A0	CAVO RJ45 - RJ45 L=3MT	1	PZ																																																						
ED1246A0	ETICHETTA SUPERFICI CALDE	2	PZ																																																						
ED1271A0	ETICHETTA PERICOLO CADUTA LIQUIDI	1	PZ																																																						
EL1020A0	RACCORDO INTERMEDIO "T" TUBO Ø8	2	PZ																																																						
EL1020A1	RACCORDO INTERMEDIO "T" TUBO D8 J	2	PZ																																																						

COMPONENTE			RICAMBIO																																																																																		
Codice	Descrizione	Immagine	Codice	Descrizione	Lista componenti																																																																																
VL1006A	COPERCHIO SIFON		XC755	KIT SOVRAPPOSIZIONE BT-CT 2/1 S.5E	<table border="1"> <thead> <tr> <th>Codice</th> <th>Descrizione</th> <th>Qtà</th> <th>UM</th> </tr> </thead> <tbody> <tr> <td>GN1508A0</td> <td>GUARNIZIONE O-RING COD 2400</td> <td>2</td> <td>PZ</td> </tr> <tr> <td>PD1069A0</td> <td>PIEDE SOVRAPPOSIZ IONE CT-BT S5-E</td> <td>1</td> <td>PZ</td> </tr> <tr> <td>RC1008A0</td> <td>FASCETTA ELASTICA D9 ZINCATA</td> <td>3</td> <td>PZ</td> </tr> <tr> <td>RC1055A0</td> <td>FASCETTA STRINGI TUBO Ø25-40 H12 INOX</td> <td>14</td> <td>PZ</td> </tr> <tr> <td>RC1130A0</td> <td>FASCETTA 130X2,6</td> <td>3</td> <td>PZ</td> </tr> <tr> <td>RC1297A0</td> <td>RACCORDO A T Ø10</td> <td>1</td> <td>PZ</td> </tr> <tr> <td>RC1297A1</td> <td>RACCORDO A T Ø10</td> <td>1</td> <td>PZ</td> </tr> <tr> <td>RC1376A0</td> <td>RACCORDO Y Ø6</td> <td>1</td> <td>PZ</td> </tr> <tr> <td>TB1520A0</td> <td>TUBO D.INT=30 SP=4 GOMMA EPDM NERO</td> <td>5</td> <td>M</td> </tr> <tr> <td>TB1765A1</td> <td>TUBO RACCORDO CAMINO KIT SOVRAP. Ø30X1</td> <td>2</td> <td>PZ</td> </tr> <tr> <td>TB2243A0</td> <td>TUBO PET Ø10</td> <td>1.500</td> <td>M</td> </tr> <tr> <td>VI1075A0</td> <td>DADO M4 H=4 INOX UNI5587</td> <td>8</td> <td>PZ</td> </tr> <tr> <td>VI1220A1</td> <td>VITE AUTOFILETTA NTE 4.2X11 TCS+ MARUTE</td> <td>4</td> <td>PZ</td> </tr> <tr> <td>VI1895A0</td> <td>DADO CIECO M4 INOX DIN 917</td> <td>8</td> <td>PZ</td> </tr> <tr> <td>VI1945A0</td> <td>VITE M4X20 TCB+ INOX</td> <td>8</td> <td>PZ</td> </tr> <tr> <td>VI1950A0</td> <td>VITE AUTOFORANT E 4,2X13 TCB INOX</td> <td>26</td> <td>PZ</td> </tr> <tr> <td>VL1005A1</td> <td>VASCA SIFON</td> <td>2</td> <td>PZ</td> </tr> <tr> <td>VL1006A0</td> <td>COPERCHIO SIFONE</td> <td>2</td> <td>PZ</td> </tr> <tr> <td>VL1043A0</td> <td>PORTAGOMM A D4-CODOLO D6</td> <td>3</td> <td>PZ</td> </tr> </tbody> </table>	Codice	Descrizione	Qtà	UM	GN1508A0	GUARNIZIONE O-RING COD 2400	2	PZ	PD1069A0	PIEDE SOVRAPPOSIZ IONE CT-BT S5-E	1	PZ	RC1008A0	FASCETTA ELASTICA D9 ZINCATA	3	PZ	RC1055A0	FASCETTA STRINGI TUBO Ø25-40 H12 INOX	14	PZ	RC1130A0	FASCETTA 130X2,6	3	PZ	RC1297A0	RACCORDO A T Ø10	1	PZ	RC1297A1	RACCORDO A T Ø10	1	PZ	RC1376A0	RACCORDO Y Ø6	1	PZ	TB1520A0	TUBO D.INT=30 SP=4 GOMMA EPDM NERO	5	M	TB1765A1	TUBO RACCORDO CAMINO KIT SOVRAP. Ø30X1	2	PZ	TB2243A0	TUBO PET Ø10	1.500	M	VI1075A0	DADO M4 H=4 INOX UNI5587	8	PZ	VI1220A1	VITE AUTOFILETTA NTE 4.2X11 TCS+ MARUTE	4	PZ	VI1895A0	DADO CIECO M4 INOX DIN 917	8	PZ	VI1945A0	VITE M4X20 TCB+ INOX	8	PZ	VI1950A0	VITE AUTOFORANT E 4,2X13 TCB INOX	26	PZ	VL1005A1	VASCA SIFON	2	PZ	VL1006A0	COPERCHIO SIFONE	2	PZ	VL1043A0	PORTAGOMM A D4-CODOLO D6	3	PZ
Codice	Descrizione	Qtà	UM																																																																																		
GN1508A0	GUARNIZIONE O-RING COD 2400	2	PZ																																																																																		
PD1069A0	PIEDE SOVRAPPOSIZ IONE CT-BT S5-E	1	PZ																																																																																		
RC1008A0	FASCETTA ELASTICA D9 ZINCATA	3	PZ																																																																																		
RC1055A0	FASCETTA STRINGI TUBO Ø25-40 H12 INOX	14	PZ																																																																																		
RC1130A0	FASCETTA 130X2,6	3	PZ																																																																																		
RC1297A0	RACCORDO A T Ø10	1	PZ																																																																																		
RC1297A1	RACCORDO A T Ø10	1	PZ																																																																																		
RC1376A0	RACCORDO Y Ø6	1	PZ																																																																																		
TB1520A0	TUBO D.INT=30 SP=4 GOMMA EPDM NERO	5	M																																																																																		
TB1765A1	TUBO RACCORDO CAMINO KIT SOVRAP. Ø30X1	2	PZ																																																																																		
TB2243A0	TUBO PET Ø10	1.500	M																																																																																		
VI1075A0	DADO M4 H=4 INOX UNI5587	8	PZ																																																																																		
VI1220A1	VITE AUTOFILETTA NTE 4.2X11 TCS+ MARUTE	4	PZ																																																																																		
VI1895A0	DADO CIECO M4 INOX DIN 917	8	PZ																																																																																		
VI1945A0	VITE M4X20 TCB+ INOX	8	PZ																																																																																		
VI1950A0	VITE AUTOFORANT E 4,2X13 TCB INOX	26	PZ																																																																																		
VL1005A1	VASCA SIFON	2	PZ																																																																																		
VL1006A0	COPERCHIO SIFONE	2	PZ																																																																																		
VL1043A0	PORTAGOMM A D4-CODOLO D6	3	PZ																																																																																		

COMPONENTE			RICAMBIO																																							
Codice	Descrizione	Immagine	Codice	Descrizione	Lista componenti																																					
VL1006A	COPERCHIO SIFON		XC755	KIT SOVRAPPOSIZIONE BT-CT 2/1 S.5E	<table border="1"> <thead> <tr> <th>Codice</th> <th>Descrizione</th> <th>Qtà</th> <th>UM</th> </tr> </thead> <tbody> <tr> <td>VL1046A1</td> <td>PORTAGOMM A D6-CODOLO D6</td> <td>3</td> <td>PZ</td> </tr> <tr> <td>VM1015A1</td> <td>CURVA A 90° INOX Ø30X1</td> <td>1</td> <td>PZ</td> </tr> <tr> <td>VM1794A0</td> <td>FASCETTA 250X4.8 PA66 NERA</td> <td>3</td> <td>PZ</td> </tr> <tr> <td>VM1987A0</td> <td>STAFFA SOVRAPPOSIZIONE FORNI</td> <td>1</td> <td>PZ</td> </tr> <tr> <td>VM2035A0</td> <td>SUPPORTO PER TUBO DI SCARICO</td> <td>2</td> <td>PZ</td> </tr> </tbody> </table>	Codice	Descrizione	Qtà	UM	VL1046A1	PORTAGOMM A D6-CODOLO D6	3	PZ	VM1015A1	CURVA A 90° INOX Ø30X1	1	PZ	VM1794A0	FASCETTA 250X4.8 PA66 NERA	3	PZ	VM1987A0	STAFFA SOVRAPPOSIZIONE FORNI	1	PZ	VM2035A0	SUPPORTO PER TUBO DI SCARICO	2	PZ													
			Codice	Descrizione	Qtà	UM																																				
			VL1046A1	PORTAGOMM A D6-CODOLO D6	3	PZ																																				
VM1015A1	CURVA A 90° INOX Ø30X1	1	PZ																																							
VM1794A0	FASCETTA 250X4.8 PA66 NERA	3	PZ																																							
VM1987A0	STAFFA SOVRAPPOSIZIONE FORNI	1	PZ																																							
VM2035A0	SUPPORTO PER TUBO DI SCARICO	2	PZ																																							
XC699	KIT PRIMA INSTALLAZIONE LM TOP	<table border="1"> <thead> <tr> <th>Codice</th> <th>Descrizione</th> <th>Qtà</th> <th>UM</th> </tr> </thead> <tbody> <tr> <td>0H1237A0</td> <td>SUPPORTO SIFONE LM TO</td> <td>1</td> <td>PZ</td> </tr> <tr> <td>GN1508A0</td> <td>GUARNIZIONE O-RING COD 2400</td> <td>1</td> <td>PZ</td> </tr> <tr> <td>RC1055A0</td> <td>FASCETTA STRINGI TUBO Ø25-40 H12 INOX</td> <td>4</td> <td>PZ</td> </tr> <tr> <td>TB1520A0</td> <td>TUBO D.INT=30 SP=4 GOMMA EPDM NERO</td> <td>2.500</td> <td>M</td> </tr> <tr> <td>VI1075A0</td> <td>DADO M4 H=4 INOX UNI5587</td> <td>4</td> <td>PZ</td> </tr> <tr> <td>VI1220A1</td> <td>VITE AUTOFILETTA NTE 4.2X11 TCS+ MARUTE</td> <td>2</td> <td>PZ</td> </tr> <tr> <td>VI1895A0</td> <td>DADO CIECO M4 INOX DIN 917</td> <td>4</td> <td>PZ</td> </tr> <tr> <td>VI1945A0</td> <td>VITE M4X20 TCB+ INOX</td> <td>4</td> <td>PZ</td> </tr> <tr> <td>VI1950A0</td> <td>VITE AUTOFORANT E 4,2X13 TCB INOX</td> <td>2</td> <td>PZ</td> </tr> </tbody> </table>	Codice	Descrizione	Qtà	UM	0H1237A0	SUPPORTO SIFONE LM TO	1	PZ	GN1508A0	GUARNIZIONE O-RING COD 2400	1	PZ	RC1055A0	FASCETTA STRINGI TUBO Ø25-40 H12 INOX	4	PZ	TB1520A0	TUBO D.INT=30 SP=4 GOMMA EPDM NERO	2.500	M	VI1075A0	DADO M4 H=4 INOX UNI5587	4	PZ	VI1220A1	VITE AUTOFILETTA NTE 4.2X11 TCS+ MARUTE	2	PZ	VI1895A0	DADO CIECO M4 INOX DIN 917	4	PZ	VI1945A0	VITE M4X20 TCB+ INOX	4	PZ	VI1950A0	VITE AUTOFORANT E 4,2X13 TCB INOX	2	PZ
Codice	Descrizione	Qtà	UM																																							
0H1237A0	SUPPORTO SIFONE LM TO	1	PZ																																							
GN1508A0	GUARNIZIONE O-RING COD 2400	1	PZ																																							
RC1055A0	FASCETTA STRINGI TUBO Ø25-40 H12 INOX	4	PZ																																							
TB1520A0	TUBO D.INT=30 SP=4 GOMMA EPDM NERO	2.500	M																																							
VI1075A0	DADO M4 H=4 INOX UNI5587	4	PZ																																							
VI1220A1	VITE AUTOFILETTA NTE 4.2X11 TCS+ MARUTE	2	PZ																																							
VI1895A0	DADO CIECO M4 INOX DIN 917	4	PZ																																							
VI1945A0	VITE M4X20 TCB+ INOX	4	PZ																																							
VI1950A0	VITE AUTOFORANT E 4,2X13 TCB INOX	2	PZ																																							
XC693	KIT PRIMA INSTALLAZIONE CT BT CL BL	<table border="1"> <thead> <tr> <th>Codice</th> <th>Descrizione</th> <th>Qtà</th> <th>UM</th> </tr> </thead> <tbody> <tr> <td>GN1508A0</td> <td>GUARNIZIONE O-RING COD 2400</td> <td>1</td> <td>PZ</td> </tr> </tbody> </table>	Codice	Descrizione	Qtà	UM	GN1508A0	GUARNIZIONE O-RING COD 2400	1	PZ																																
Codice	Descrizione	Qtà	UM																																							
GN1508A0	GUARNIZIONE O-RING COD 2400	1	PZ																																							

COMPONENTE			RICAMBIO																																														
Codice	Descrizione	Immagine	Codice	Descrizione	Lista componenti																																												
VL1006A	COPERCHIO SIFON		XC693	KIT PRIMA INSTALLAZIONE CT BT CL BL	<table border="1"> <thead> <tr> <th>Codice</th> <th>Descrizione</th> <th>Qtà</th> <th>UM</th> </tr> </thead> <tbody> <tr> <td>RC1055A0</td> <td>FASCETTA STRINGI TUBO Ø25-40 H12 INOX</td> <td>3</td> <td>PZ</td> </tr> <tr> <td>TB1520A0</td> <td>TUBO D.INT=30 SP=4 GOMMA EPDM NERO</td> <td>2.500</td> <td>M</td> </tr> <tr> <td>VI1075A0</td> <td>DADO M4 H=4 INOX UNI5587</td> <td>4</td> <td>PZ</td> </tr> <tr> <td>VI1220A1</td> <td>VITE AUTOFILETTA NTE 4.2X11 TCS+ MARUTE</td> <td>2</td> <td>PZ</td> </tr> <tr> <td>VI1895A0</td> <td>DADO CIECO M4 INOX DIN 917</td> <td>4</td> <td>PZ</td> </tr> <tr> <td>VI1945A0</td> <td>VITE M4X20 TCB+ INOX</td> <td>4</td> <td>PZ</td> </tr> <tr> <td>VI1950A0</td> <td>VITE AUTOFORANT E 4,2X13 TCB INOX</td> <td>2</td> <td>PZ</td> </tr> <tr> <td>VL1005A1</td> <td>VASCA SIFON</td> <td>1</td> <td>PZ</td> </tr> <tr> <td>VL1006A0</td> <td>COPERCHIO SIFONE</td> <td>1</td> <td>PZ</td> </tr> <tr> <td>VM1015A1</td> <td>CURVA A 90° INOX Ø30X1</td> <td>1</td> <td>PZ</td> </tr> </tbody> </table>	Codice	Descrizione	Qtà	UM	RC1055A0	FASCETTA STRINGI TUBO Ø25-40 H12 INOX	3	PZ	TB1520A0	TUBO D.INT=30 SP=4 GOMMA EPDM NERO	2.500	M	VI1075A0	DADO M4 H=4 INOX UNI5587	4	PZ	VI1220A1	VITE AUTOFILETTA NTE 4.2X11 TCS+ MARUTE	2	PZ	VI1895A0	DADO CIECO M4 INOX DIN 917	4	PZ	VI1945A0	VITE M4X20 TCB+ INOX	4	PZ	VI1950A0	VITE AUTOFORANT E 4,2X13 TCB INOX	2	PZ	VL1005A1	VASCA SIFON	1	PZ	VL1006A0	COPERCHIO SIFONE	1	PZ	VM1015A1	CURVA A 90° INOX Ø30X1	1	PZ
			Codice	Descrizione	Qtà	UM																																											
RC1055A0	FASCETTA STRINGI TUBO Ø25-40 H12 INOX	3	PZ																																														
TB1520A0	TUBO D.INT=30 SP=4 GOMMA EPDM NERO	2.500	M																																														
VI1075A0	DADO M4 H=4 INOX UNI5587	4	PZ																																														
VI1220A1	VITE AUTOFILETTA NTE 4.2X11 TCS+ MARUTE	2	PZ																																														
VI1895A0	DADO CIECO M4 INOX DIN 917	4	PZ																																														
VI1945A0	VITE M4X20 TCB+ INOX	4	PZ																																														
VI1950A0	VITE AUTOFORANT E 4,2X13 TCB INOX	2	PZ																																														
VL1005A1	VASCA SIFON	1	PZ																																														
VL1006A0	COPERCHIO SIFONE	1	PZ																																														
VM1015A1	CURVA A 90° INOX Ø30X1	1	PZ																																														
XC673	KIT SIFONE COMPLETO	<table border="1"> <thead> <tr> <th>Codice</th> <th>Descrizione</th> <th>Qtà</th> <th>UM</th> </tr> </thead> <tbody> <tr> <td>GN1508A0</td> <td>GUARNIZIONE O-RING COD 2400</td> <td>1</td> <td>PZ</td> </tr> <tr> <td>RC1055A0</td> <td>FASCETTA STRINGI TUBO Ø25-40 H12 INOX</td> <td>2</td> <td>PZ</td> </tr> <tr> <td>TB1520A0</td> <td>TUBO D.INT=30 SP=4 GOMMA EPDM NERO</td> <td>0.050</td> <td>M</td> </tr> <tr> <td>VI1075A0</td> <td>DADO M4 H=4 INOX UNI5587</td> <td>4</td> <td>PZ</td> </tr> <tr> <td>VI1220A1</td> <td>VITE AUTOFILETTA NTE 4.2X11 TCS+ MARUTE</td> <td>2</td> <td>PZ</td> </tr> <tr> <td>VI1895A0</td> <td>DADO CIECO M4 INOX DIN 917</td> <td>4</td> <td>PZ</td> </tr> <tr> <td>VI1945A0</td> <td>VITE M4X20 TCB+ INOX</td> <td>4</td> <td>PZ</td> </tr> </tbody> </table>	Codice	Descrizione	Qtà	UM	GN1508A0	GUARNIZIONE O-RING COD 2400	1	PZ	RC1055A0	FASCETTA STRINGI TUBO Ø25-40 H12 INOX	2	PZ	TB1520A0	TUBO D.INT=30 SP=4 GOMMA EPDM NERO	0.050	M	VI1075A0	DADO M4 H=4 INOX UNI5587	4	PZ	VI1220A1	VITE AUTOFILETTA NTE 4.2X11 TCS+ MARUTE	2	PZ	VI1895A0	DADO CIECO M4 INOX DIN 917	4	PZ	VI1945A0	VITE M4X20 TCB+ INOX	4	PZ															
Codice	Descrizione	Qtà	UM																																														
GN1508A0	GUARNIZIONE O-RING COD 2400	1	PZ																																														
RC1055A0	FASCETTA STRINGI TUBO Ø25-40 H12 INOX	2	PZ																																														
TB1520A0	TUBO D.INT=30 SP=4 GOMMA EPDM NERO	0.050	M																																														
VI1075A0	DADO M4 H=4 INOX UNI5587	4	PZ																																														
VI1220A1	VITE AUTOFILETTA NTE 4.2X11 TCS+ MARUTE	2	PZ																																														
VI1895A0	DADO CIECO M4 INOX DIN 917	4	PZ																																														
VI1945A0	VITE M4X20 TCB+ INOX	4	PZ																																														

COMPONENTE			RICAMBIO																																																															
Codice	Descrizione	Immagine	Codice	Descrizione	Lista componenti																																																													
VL1006A	COPERCHIO SIFON		XC673	KIT SIFONE COMPLETO	<table border="1"> <thead> <tr> <th>Codice</th> <th>Descrizione</th> <th>Qtà</th> <th>UM</th> </tr> </thead> <tbody> <tr> <td>VI1950A0</td> <td>VITE AUTOFORANT E 4,2X13 TCB INOX</td> <td>2</td> <td>PZ</td> </tr> <tr> <td>VL1005A1</td> <td>VASCA SIFON</td> <td>1</td> <td>PZ</td> </tr> <tr> <td>VL1006A0</td> <td>COPERCHIO SIFONE</td> <td>1</td> <td>PZ</td> </tr> </tbody> </table>	Codice	Descrizione	Qtà	UM	VI1950A0	VITE AUTOFORANT E 4,2X13 TCB INOX	2	PZ	VL1005A1	VASCA SIFON	1	PZ	VL1006A0	COPERCHIO SIFONE	1	PZ																																													
			Codice	Descrizione	Qtà	UM																																																												
VI1950A0	VITE AUTOFORANT E 4,2X13 TCB INOX	2	PZ																																																															
VL1005A1	VASCA SIFON	1	PZ																																																															
VL1006A0	COPERCHIO SIFONE	1	PZ																																																															
XC653	KIT SOVRAPPOSIZIONE LM TOP 600	<table border="1"> <thead> <tr> <th>Codice</th> <th>Descrizione</th> <th>Qtà</th> <th>UM</th> </tr> </thead> <tbody> <tr> <td>0H1237A0</td> <td>SUPPORTO SIFONE LM TO</td> <td>2</td> <td>PZ</td> </tr> <tr> <td>0H7084A0</td> <td>PROFILO FRONTALE KIT SOVRAP.LM60 0 XC651</td> <td>1</td> <td>PZ</td> </tr> <tr> <td>0H7085A0</td> <td>PROFILO POSTERIORE KIT SOVRAP.LM 600 XC</td> <td>2</td> <td>PZ</td> </tr> <tr> <td>ED1246A0</td> <td>ETICHETTA SUPERFICI CALDE</td> <td>1</td> <td>PZ</td> </tr> <tr> <td>ED1271A0</td> <td>ETICHETTA PERICOLO CADUTA LIQUIDI</td> <td>1</td> <td>PZ</td> </tr> <tr> <td>EL1020A0</td> <td>RACCORDO INTERMEDIO "T" TUBO Ø8</td> <td>2</td> <td>PZ</td> </tr> <tr> <td>EL1020A1</td> <td>RACCORDO INTERMEDIO "T" TUBO D8 J</td> <td>2</td> <td>PZ</td> </tr> <tr> <td>EL1180A0</td> <td>RACCORDO NON RITORNO Ø8 Ø8 FEMMIN</td> <td>2</td> <td>PZ</td> </tr> <tr> <td>GN1508A0</td> <td>GUARNIZIONE O-RING COD 2400</td> <td>2</td> <td>PZ</td> </tr> <tr> <td>RC1008A0</td> <td>FASCETTA ELASTICA D9 ZINCATA</td> <td>7</td> <td>PZ</td> </tr> <tr> <td>RC1055A0</td> <td>FASCETTA STRINGI TUBO Ø25-40 H12 INOX</td> <td>10</td> <td>PZ</td> </tr> <tr> <td>RC1297A0</td> <td>RACCORDO A T Ø10</td> <td>1</td> <td>PZ</td> </tr> <tr> <td>RC1297A1</td> <td>RACCORDO A T Ø10</td> <td>1</td> <td>PZ</td> </tr> <tr> <td>RC1360A0</td> <td>RACCORDO GOMITO JG 10-10</td> <td>1</td> <td>PZ</td> </tr> <tr> <td>RC1376A0</td> <td>RACCORDO Y Ø6</td> <td>1</td> <td>PZ</td> </tr> </tbody> </table>	Codice	Descrizione	Qtà	UM	0H1237A0	SUPPORTO SIFONE LM TO	2	PZ	0H7084A0	PROFILO FRONTALE KIT SOVRAP.LM60 0 XC651	1	PZ	0H7085A0	PROFILO POSTERIORE KIT SOVRAP.LM 600 XC	2	PZ	ED1246A0	ETICHETTA SUPERFICI CALDE	1	PZ	ED1271A0	ETICHETTA PERICOLO CADUTA LIQUIDI	1	PZ	EL1020A0	RACCORDO INTERMEDIO "T" TUBO Ø8	2	PZ	EL1020A1	RACCORDO INTERMEDIO "T" TUBO D8 J	2	PZ	EL1180A0	RACCORDO NON RITORNO Ø8 Ø8 FEMMIN	2	PZ	GN1508A0	GUARNIZIONE O-RING COD 2400	2	PZ	RC1008A0	FASCETTA ELASTICA D9 ZINCATA	7	PZ	RC1055A0	FASCETTA STRINGI TUBO Ø25-40 H12 INOX	10	PZ	RC1297A0	RACCORDO A T Ø10	1	PZ	RC1297A1	RACCORDO A T Ø10	1	PZ	RC1360A0	RACCORDO GOMITO JG 10-10	1	PZ	RC1376A0	RACCORDO Y Ø6	1	PZ
Codice	Descrizione	Qtà	UM																																																															
0H1237A0	SUPPORTO SIFONE LM TO	2	PZ																																																															
0H7084A0	PROFILO FRONTALE KIT SOVRAP.LM60 0 XC651	1	PZ																																																															
0H7085A0	PROFILO POSTERIORE KIT SOVRAP.LM 600 XC	2	PZ																																																															
ED1246A0	ETICHETTA SUPERFICI CALDE	1	PZ																																																															
ED1271A0	ETICHETTA PERICOLO CADUTA LIQUIDI	1	PZ																																																															
EL1020A0	RACCORDO INTERMEDIO "T" TUBO Ø8	2	PZ																																																															
EL1020A1	RACCORDO INTERMEDIO "T" TUBO D8 J	2	PZ																																																															
EL1180A0	RACCORDO NON RITORNO Ø8 Ø8 FEMMIN	2	PZ																																																															
GN1508A0	GUARNIZIONE O-RING COD 2400	2	PZ																																																															
RC1008A0	FASCETTA ELASTICA D9 ZINCATA	7	PZ																																																															
RC1055A0	FASCETTA STRINGI TUBO Ø25-40 H12 INOX	10	PZ																																																															
RC1297A0	RACCORDO A T Ø10	1	PZ																																																															
RC1297A1	RACCORDO A T Ø10	1	PZ																																																															
RC1360A0	RACCORDO GOMITO JG 10-10	1	PZ																																																															
RC1376A0	RACCORDO Y Ø6	1	PZ																																																															

COMPONENTE			RICAMBIO																																																																																									
Codice	Descrizione	Immagine	Codice	Descrizione	Lista componenti																																																																																							
VL1006A	COPERCHIO SIFON		XC653	KIT SOVRAPPOSIZIONE LM TOP 600	<table border="1"> <thead> <tr> <th>Codice</th> <th>Descrizione</th> <th>Qtà</th> <th>UM</th> </tr> </thead> <tbody> <tr> <td>TB1177A0</td> <td>PIEDE QUADRO 40X40 H58 SOVRAP. LM</td> <td>4</td> <td>PZ</td> </tr> <tr> <td>TB1520A0</td> <td>TUBO D.INT=30 SP=4 GOMMA EPDM NERO</td> <td>2.700</td> <td>M</td> </tr> <tr> <td>TB1815A0</td> <td>TUBO PE 7,93X4,75 TRASPARENT</td> <td>2</td> <td>M</td> </tr> <tr> <td>TB2243A0</td> <td>TUBO PET Ø10</td> <td>1.500</td> <td>M</td> </tr> <tr> <td>VI1075A0</td> <td>DADO M4 H=4 INOX UNI5587</td> <td>8</td> <td>PZ</td> </tr> <tr> <td>VI1220A1</td> <td>VITE AUTOFILETTA NTE 4.2X11 TCS+ MARUTE</td> <td>16</td> <td>PZ</td> </tr> <tr> <td>VI1895A0</td> <td>DADO CIECO M4 INOX DIN 917</td> <td>8</td> <td>PZ</td> </tr> <tr> <td>VI1945A0</td> <td>VITE M4X20 TCB+ INOX</td> <td>8</td> <td>PZ</td> </tr> <tr> <td>VI1950A0</td> <td>VITE AUTOFORANT E 4,2X13 TCB INOX</td> <td>10</td> <td>PZ</td> </tr> <tr> <td>VL1005A1</td> <td>VASCA SIFON</td> <td>2</td> <td>PZ</td> </tr> <tr> <td>VL1006A0</td> <td>COPERCHIO SIFONE</td> <td>2</td> <td>PZ</td> </tr> <tr> <td>VL1046A1</td> <td>PORTAGOMM A D6-CODOLO D6</td> <td>7</td> <td>PZ</td> </tr> <tr> <td>VL1047A1</td> <td>PORTAGOMM A D6 CODOLO D8</td> <td>2</td> <td>PZ</td> </tr> <tr> <td>VL1047A2</td> <td>PORTAGOMM A D6 CODOLO D8</td> <td>2</td> <td>PZ</td> </tr> <tr> <td>VM1015A1</td> <td>CURVA A 90° INOX Ø30X1</td> <td>1</td> <td>PZ</td> </tr> <tr> <td>VM1794A0</td> <td>FASCETTA 250X4.8 PA66 NERA</td> <td>2</td> <td>PZ</td> </tr> <tr> <td>VM2035A0</td> <td>SUPPORTO PER TUBO DI SCARICO</td> <td>1</td> <td>PZ</td> </tr> </tbody> </table>	Codice	Descrizione	Qtà	UM	TB1177A0	PIEDE QUADRO 40X40 H58 SOVRAP. LM	4	PZ	TB1520A0	TUBO D.INT=30 SP=4 GOMMA EPDM NERO	2.700	M	TB1815A0	TUBO PE 7,93X4,75 TRASPARENT	2	M	TB2243A0	TUBO PET Ø10	1.500	M	VI1075A0	DADO M4 H=4 INOX UNI5587	8	PZ	VI1220A1	VITE AUTOFILETTA NTE 4.2X11 TCS+ MARUTE	16	PZ	VI1895A0	DADO CIECO M4 INOX DIN 917	8	PZ	VI1945A0	VITE M4X20 TCB+ INOX	8	PZ	VI1950A0	VITE AUTOFORANT E 4,2X13 TCB INOX	10	PZ	VL1005A1	VASCA SIFON	2	PZ	VL1006A0	COPERCHIO SIFONE	2	PZ	VL1046A1	PORTAGOMM A D6-CODOLO D6	7	PZ	VL1047A1	PORTAGOMM A D6 CODOLO D8	2	PZ	VL1047A2	PORTAGOMM A D6 CODOLO D8	2	PZ	VM1015A1	CURVA A 90° INOX Ø30X1	1	PZ	VM1794A0	FASCETTA 250X4.8 PA66 NERA	2	PZ	VM2035A0	SUPPORTO PER TUBO DI SCARICO	1	PZ	XC649	KIT SOVRAPPOSIZIONE LM TOP 800 USA	<table border="1"> <thead> <tr> <th>Codice</th> <th>Descrizione</th> <th>Qtà</th> <th>UM</th> </tr> </thead> <tbody> <tr> <td>0H1151A0</td> <td>STAFFA FISSAGGIO LIEVITATORE- FORNO</td> <td>4</td> <td>PZ</td> </tr> <tr> <td>0H1237A0</td> <td>SUPPORTO SIFONE LM TO</td> <td>2</td> <td>PZ</td> </tr> </tbody> </table>	Codice	Descrizione	Qtà	UM	0H1151A0	STAFFA FISSAGGIO LIEVITATORE- FORNO	4	PZ	0H1237A0	SUPPORTO SIFONE LM TO	2	PZ
			Codice	Descrizione	Qtà	UM																																																																																						
TB1177A0	PIEDE QUADRO 40X40 H58 SOVRAP. LM	4	PZ																																																																																									
TB1520A0	TUBO D.INT=30 SP=4 GOMMA EPDM NERO	2.700	M																																																																																									
TB1815A0	TUBO PE 7,93X4,75 TRASPARENT	2	M																																																																																									
TB2243A0	TUBO PET Ø10	1.500	M																																																																																									
VI1075A0	DADO M4 H=4 INOX UNI5587	8	PZ																																																																																									
VI1220A1	VITE AUTOFILETTA NTE 4.2X11 TCS+ MARUTE	16	PZ																																																																																									
VI1895A0	DADO CIECO M4 INOX DIN 917	8	PZ																																																																																									
VI1945A0	VITE M4X20 TCB+ INOX	8	PZ																																																																																									
VI1950A0	VITE AUTOFORANT E 4,2X13 TCB INOX	10	PZ																																																																																									
VL1005A1	VASCA SIFON	2	PZ																																																																																									
VL1006A0	COPERCHIO SIFONE	2	PZ																																																																																									
VL1046A1	PORTAGOMM A D6-CODOLO D6	7	PZ																																																																																									
VL1047A1	PORTAGOMM A D6 CODOLO D8	2	PZ																																																																																									
VL1047A2	PORTAGOMM A D6 CODOLO D8	2	PZ																																																																																									
VM1015A1	CURVA A 90° INOX Ø30X1	1	PZ																																																																																									
VM1794A0	FASCETTA 250X4.8 PA66 NERA	2	PZ																																																																																									
VM2035A0	SUPPORTO PER TUBO DI SCARICO	1	PZ																																																																																									
Codice	Descrizione	Qtà	UM																																																																																									
0H1151A0	STAFFA FISSAGGIO LIEVITATORE- FORNO	4	PZ																																																																																									
0H1237A0	SUPPORTO SIFONE LM TO	2	PZ																																																																																									

COMPONENTE			RICAMBIO																																																																														
Codice	Descrizione	Immagine	Codice	Descrizione	Lista componenti																																																																												
VL1006A	COPERCHIO SIFON		XC649	KIT SOVRAPPOSIZIONE LM TOP 800 USA	<table border="1"> <thead> <tr> <th>Codice</th> <th>Descrizione</th> <th>Qtà</th> <th>UM</th> </tr> </thead> <tbody> <tr> <td>ED1335A0</td> <td>ETICHETTA TRIANGOLO CAUTION HOT</td> <td>1</td> <td>PZ</td> </tr> <tr> <td>ED1338A0</td> <td>ETICHETTA PERICOLO CADUTA LIQUIDI UL</td> <td>1</td> <td>PZ</td> </tr> <tr> <td>EL1020A0</td> <td>RACCORDO INTERMEDIO "T" TUBO Ø8</td> <td>2</td> <td>PZ</td> </tr> <tr> <td>EL1020A1</td> <td>RACCORDO INTERMEDIO "T" TUBO D8 J</td> <td>2</td> <td>PZ</td> </tr> <tr> <td>EL1185A0</td> <td>RACCORDO A GOMITO J.GUEST Ø8F - Ø8F</td> <td>2</td> <td>PZ</td> </tr> <tr> <td>EL1185B0</td> <td>RACCORDO GOMITO Ø8F-Ø8F</td> <td>2</td> <td>PZ</td> </tr> <tr> <td>GN1508A0</td> <td>GUARNIZIONE O-RING COD 2400</td> <td>2</td> <td>PZ</td> </tr> <tr> <td>RC1008A0</td> <td>FASCETTA ELASTICA D9 ZINCATA</td> <td>3</td> <td>PZ</td> </tr> <tr> <td>RC1055A0</td> <td>FASCETTA STRINGI TUBO Ø25-40 H12 INOX</td> <td>8</td> <td>PZ</td> </tr> <tr> <td>RC1297A0</td> <td>RACCORDO A T Ø10</td> <td>1</td> <td>PZ</td> </tr> <tr> <td>RC1297A1</td> <td>RACCORDO A T Ø10</td> <td>1</td> <td>PZ</td> </tr> <tr> <td>RC1360A0</td> <td>RACCORDO GOMITO JG 10-10</td> <td>1</td> <td>PZ</td> </tr> <tr> <td>RC1376A0</td> <td>RACCORDO Y Ø6</td> <td>1</td> <td>PZ</td> </tr> <tr> <td>TB1520A0</td> <td>TUBO D.INT=30 SP=4 GOMMA EPDM NERO</td> <td>2.840</td> <td>M</td> </tr> <tr> <td>TB1815A0</td> <td>TUBO PE 7,93X4,75 TRASPARENT</td> <td>2</td> <td>M</td> </tr> <tr> <td>TB2243A0</td> <td>TUBO PET Ø10</td> <td>1.500</td> <td>M</td> </tr> <tr> <td>VI1075A0</td> <td>DADO M4 H=4 INOX UNI5587</td> <td>8</td> <td>PZ</td> </tr> <tr> <td>VI1220A1</td> <td>VITE AUTOFILETTA NTE 4.2X11 TCS+ MARUTE</td> <td>7</td> <td>PZ</td> </tr> </tbody> </table>	Codice	Descrizione	Qtà	UM	ED1335A0	ETICHETTA TRIANGOLO CAUTION HOT	1	PZ	ED1338A0	ETICHETTA PERICOLO CADUTA LIQUIDI UL	1	PZ	EL1020A0	RACCORDO INTERMEDIO "T" TUBO Ø8	2	PZ	EL1020A1	RACCORDO INTERMEDIO "T" TUBO D8 J	2	PZ	EL1185A0	RACCORDO A GOMITO J.GUEST Ø8F - Ø8F	2	PZ	EL1185B0	RACCORDO GOMITO Ø8F-Ø8F	2	PZ	GN1508A0	GUARNIZIONE O-RING COD 2400	2	PZ	RC1008A0	FASCETTA ELASTICA D9 ZINCATA	3	PZ	RC1055A0	FASCETTA STRINGI TUBO Ø25-40 H12 INOX	8	PZ	RC1297A0	RACCORDO A T Ø10	1	PZ	RC1297A1	RACCORDO A T Ø10	1	PZ	RC1360A0	RACCORDO GOMITO JG 10-10	1	PZ	RC1376A0	RACCORDO Y Ø6	1	PZ	TB1520A0	TUBO D.INT=30 SP=4 GOMMA EPDM NERO	2.840	M	TB1815A0	TUBO PE 7,93X4,75 TRASPARENT	2	M	TB2243A0	TUBO PET Ø10	1.500	M	VI1075A0	DADO M4 H=4 INOX UNI5587	8	PZ	VI1220A1	VITE AUTOFILETTA NTE 4.2X11 TCS+ MARUTE	7	PZ
Codice	Descrizione	Qtà	UM																																																																														
ED1335A0	ETICHETTA TRIANGOLO CAUTION HOT	1	PZ																																																																														
ED1338A0	ETICHETTA PERICOLO CADUTA LIQUIDI UL	1	PZ																																																																														
EL1020A0	RACCORDO INTERMEDIO "T" TUBO Ø8	2	PZ																																																																														
EL1020A1	RACCORDO INTERMEDIO "T" TUBO D8 J	2	PZ																																																																														
EL1185A0	RACCORDO A GOMITO J.GUEST Ø8F - Ø8F	2	PZ																																																																														
EL1185B0	RACCORDO GOMITO Ø8F-Ø8F	2	PZ																																																																														
GN1508A0	GUARNIZIONE O-RING COD 2400	2	PZ																																																																														
RC1008A0	FASCETTA ELASTICA D9 ZINCATA	3	PZ																																																																														
RC1055A0	FASCETTA STRINGI TUBO Ø25-40 H12 INOX	8	PZ																																																																														
RC1297A0	RACCORDO A T Ø10	1	PZ																																																																														
RC1297A1	RACCORDO A T Ø10	1	PZ																																																																														
RC1360A0	RACCORDO GOMITO JG 10-10	1	PZ																																																																														
RC1376A0	RACCORDO Y Ø6	1	PZ																																																																														
TB1520A0	TUBO D.INT=30 SP=4 GOMMA EPDM NERO	2.840	M																																																																														
TB1815A0	TUBO PE 7,93X4,75 TRASPARENT	2	M																																																																														
TB2243A0	TUBO PET Ø10	1.500	M																																																																														
VI1075A0	DADO M4 H=4 INOX UNI5587	8	PZ																																																																														
VI1220A1	VITE AUTOFILETTA NTE 4.2X11 TCS+ MARUTE	7	PZ																																																																														



COMPONENTE			RICAMBIO																																										
Codice	Descrizione	Immagine	Codice	Descrizione	Lista componenti																																								
VL1006A	COPERCHIO SIFON		XC649	KIT SOVRAPPOSIZIONE LM TOP 800 USA	<table border="1"> <thead> <tr> <th>Codice</th> <th>Descrizione</th> <th>Qtà</th> <th>UM</th> </tr> </thead> <tbody> <tr> <td>VI1895A0</td> <td>DADO CIECO M4 INOX DIN 917</td> <td>8</td> <td>PZ</td> </tr> <tr> <td>VI1945A0</td> <td>VITE M4X20 TCB+ INOX</td> <td>8</td> <td>PZ</td> </tr> <tr> <td>VI1950A0</td> <td>VITE AUTOFORANT E 4,2X13 TCB INOX</td> <td>6</td> <td>PZ</td> </tr> <tr> <td>VL1005A1</td> <td>VASCA SIFON</td> <td>2</td> <td>PZ</td> </tr> <tr> <td>VL1006A0</td> <td>COPERCHIO SIFONE</td> <td>2</td> <td>PZ</td> </tr> <tr> <td>VL1046A1</td> <td>PORTAGOMM A D6-CODOLO D6</td> <td>3</td> <td>PZ</td> </tr> <tr> <td>VM1794A0</td> <td>FASCETTA 250X4.8 PA66 NERA</td> <td>2</td> <td>PZ</td> </tr> <tr> <td>VM2035A0</td> <td>SUPPORTO PER TUBO DI SCARICO</td> <td>1</td> <td>PZ</td> </tr> </tbody> </table>	Codice	Descrizione	Qtà	UM	VI1895A0	DADO CIECO M4 INOX DIN 917	8	PZ	VI1945A0	VITE M4X20 TCB+ INOX	8	PZ	VI1950A0	VITE AUTOFORANT E 4,2X13 TCB INOX	6	PZ	VL1005A1	VASCA SIFON	2	PZ	VL1006A0	COPERCHIO SIFONE	2	PZ	VL1046A1	PORTAGOMM A D6-CODOLO D6	3	PZ	VM1794A0	FASCETTA 250X4.8 PA66 NERA	2	PZ	VM2035A0	SUPPORTO PER TUBO DI SCARICO	1	PZ				
Codice	Descrizione	Qtà	UM																																										
VI1895A0	DADO CIECO M4 INOX DIN 917	8	PZ																																										
VI1945A0	VITE M4X20 TCB+ INOX	8	PZ																																										
VI1950A0	VITE AUTOFORANT E 4,2X13 TCB INOX	6	PZ																																										
VL1005A1	VASCA SIFON	2	PZ																																										
VL1006A0	COPERCHIO SIFONE	2	PZ																																										
VL1046A1	PORTAGOMM A D6-CODOLO D6	3	PZ																																										
VM1794A0	FASCETTA 250X4.8 PA66 NERA	2	PZ																																										
VM2035A0	SUPPORTO PER TUBO DI SCARICO	1	PZ																																										
			XC648	KIT SOVRAPPOSIZIONE LM TOP 800	<table border="1"> <thead> <tr> <th>Codice</th> <th>Descrizione</th> <th>Qtà</th> <th>UM</th> </tr> </thead> <tbody> <tr> <td>0H1237A0</td> <td>SUPPORTO SIFONE LM TO</td> <td>2</td> <td>PZ</td> </tr> <tr> <td>0H7082A0</td> <td>PROFILO FRONTALE KIT SOVRAP.LM 800 XC64</td> <td>1</td> <td>PZ</td> </tr> <tr> <td>0H7083A0</td> <td>PROFILO POSTERIORE KIT SOVRAP.LM 800 XC</td> <td>2</td> <td>PZ</td> </tr> <tr> <td>ED1246A0</td> <td>ETICHETTA SUPERFICI CALDE</td> <td>1</td> <td>PZ</td> </tr> <tr> <td>ED1271A0</td> <td>ETICHETTA PERICOLO CADUTA LIQUIDI</td> <td>1</td> <td>PZ</td> </tr> <tr> <td>EL1020A0</td> <td>RACCORDO INTERMEDIO "T" TUBO Ø8</td> <td>2</td> <td>PZ</td> </tr> <tr> <td>EL1020A1</td> <td>RACCORDO INTERMEDIO "T" TUBO D8 J</td> <td>2</td> <td>PZ</td> </tr> <tr> <td>EL1180A0</td> <td>RACCORDO NON RITORNO Ø8 Ø8 FEMMIN</td> <td>2</td> <td>PZ</td> </tr> <tr> <td>GN1508A0</td> <td>GUARNIZIONE O-RING COD 2400</td> <td>2</td> <td>PZ</td> </tr> </tbody> </table>	Codice	Descrizione	Qtà	UM	0H1237A0	SUPPORTO SIFONE LM TO	2	PZ	0H7082A0	PROFILO FRONTALE KIT SOVRAP.LM 800 XC64	1	PZ	0H7083A0	PROFILO POSTERIORE KIT SOVRAP.LM 800 XC	2	PZ	ED1246A0	ETICHETTA SUPERFICI CALDE	1	PZ	ED1271A0	ETICHETTA PERICOLO CADUTA LIQUIDI	1	PZ	EL1020A0	RACCORDO INTERMEDIO "T" TUBO Ø8	2	PZ	EL1020A1	RACCORDO INTERMEDIO "T" TUBO D8 J	2	PZ	EL1180A0	RACCORDO NON RITORNO Ø8 Ø8 FEMMIN	2	PZ	GN1508A0	GUARNIZIONE O-RING COD 2400	2	PZ
Codice	Descrizione	Qtà	UM																																										
0H1237A0	SUPPORTO SIFONE LM TO	2	PZ																																										
0H7082A0	PROFILO FRONTALE KIT SOVRAP.LM 800 XC64	1	PZ																																										
0H7083A0	PROFILO POSTERIORE KIT SOVRAP.LM 800 XC	2	PZ																																										
ED1246A0	ETICHETTA SUPERFICI CALDE	1	PZ																																										
ED1271A0	ETICHETTA PERICOLO CADUTA LIQUIDI	1	PZ																																										
EL1020A0	RACCORDO INTERMEDIO "T" TUBO Ø8	2	PZ																																										
EL1020A1	RACCORDO INTERMEDIO "T" TUBO D8 J	2	PZ																																										
EL1180A0	RACCORDO NON RITORNO Ø8 Ø8 FEMMIN	2	PZ																																										
GN1508A0	GUARNIZIONE O-RING COD 2400	2	PZ																																										

COMPONENTE			RICAMBIO																																																																																						
Codice	Descrizione	Immagine	Codice	Descrizione	Lista componenti																																																																																				
VL1006A	COPERCHIO SIFON		XC648	KIT SOVRAPPOSIZIONE LM TOP 800	<table border="1"> <thead> <tr> <th>Codice</th> <th>Descrizione</th> <th>Qtà</th> <th>UM</th> </tr> </thead> <tbody> <tr> <td>RC1008A0</td> <td>FASCETTA ELASTICA D9 ZINCATA</td> <td>7</td> <td>PZ</td> </tr> <tr> <td>RC1055A0</td> <td>FASCETTA STRINGI TUBO Ø25-40 H12 INOX</td> <td>10</td> <td>PZ</td> </tr> <tr> <td>RC1297A0</td> <td>RACCORDO A T Ø10</td> <td>1</td> <td>PZ</td> </tr> <tr> <td>RC1297A1</td> <td>RACCORDO A T Ø10</td> <td>1</td> <td>PZ</td> </tr> <tr> <td>RC1360A0</td> <td>RACCORDO GOMITO JG 10-10</td> <td>1</td> <td>PZ</td> </tr> <tr> <td>RC1376A0</td> <td>RACCORDO Y Ø6</td> <td>1</td> <td>PZ</td> </tr> <tr> <td>TB1177A0</td> <td>PIEDE QUADRO 40X40 H58 SOVRAP. LM</td> <td>4</td> <td>PZ</td> </tr> <tr> <td>TB1520A0</td> <td>TUBO D.INT=30 SP=4 GOMMA EPDM NERO</td> <td>2.700</td> <td>M</td> </tr> <tr> <td>TB1815A0</td> <td>TUBO PE 7,93X4,75 TRASPARENT</td> <td>2</td> <td>M</td> </tr> <tr> <td>TB2243A0</td> <td>TUBO PET Ø10</td> <td>1.500</td> <td>M</td> </tr> <tr> <td>VI1075A0</td> <td>DADO M4 H=4 INOX UNI5587</td> <td>8</td> <td>PZ</td> </tr> <tr> <td>VI1220A1</td> <td>VITE AUTOFILETTA NTE 4.2X11 TCS+ MARUTE</td> <td>16</td> <td>PZ</td> </tr> <tr> <td>VI1895A0</td> <td>DADO CIECO M4 INOX DIN 917</td> <td>8</td> <td>PZ</td> </tr> <tr> <td>VI1945A0</td> <td>VITE M4X20 TCB+ INOX</td> <td>8</td> <td>PZ</td> </tr> <tr> <td>VI1950A0</td> <td>VITE AUTOFORANT E 4,2X13 TCB INOX</td> <td>10</td> <td>PZ</td> </tr> <tr> <td>VL1005A1</td> <td>VASCA SIFON</td> <td>2</td> <td>PZ</td> </tr> <tr> <td>VL1006A0</td> <td>COPERCHIO SIFONE</td> <td>2</td> <td>PZ</td> </tr> <tr> <td>VL1046A1</td> <td>PORTAGOMM A D6-CODOLO D6</td> <td>7</td> <td>PZ</td> </tr> <tr> <td>VL1047A1</td> <td>PORTAGOMM A D6 CODOLO D8</td> <td>2</td> <td>PZ</td> </tr> <tr> <td>VL1047A2</td> <td>PORTAGOMM A D6 CODOLO D8</td> <td>2</td> <td>PZ</td> </tr> </tbody> </table>	Codice	Descrizione	Qtà	UM	RC1008A0	FASCETTA ELASTICA D9 ZINCATA	7	PZ	RC1055A0	FASCETTA STRINGI TUBO Ø25-40 H12 INOX	10	PZ	RC1297A0	RACCORDO A T Ø10	1	PZ	RC1297A1	RACCORDO A T Ø10	1	PZ	RC1360A0	RACCORDO GOMITO JG 10-10	1	PZ	RC1376A0	RACCORDO Y Ø6	1	PZ	TB1177A0	PIEDE QUADRO 40X40 H58 SOVRAP. LM	4	PZ	TB1520A0	TUBO D.INT=30 SP=4 GOMMA EPDM NERO	2.700	M	TB1815A0	TUBO PE 7,93X4,75 TRASPARENT	2	M	TB2243A0	TUBO PET Ø10	1.500	M	VI1075A0	DADO M4 H=4 INOX UNI5587	8	PZ	VI1220A1	VITE AUTOFILETTA NTE 4.2X11 TCS+ MARUTE	16	PZ	VI1895A0	DADO CIECO M4 INOX DIN 917	8	PZ	VI1945A0	VITE M4X20 TCB+ INOX	8	PZ	VI1950A0	VITE AUTOFORANT E 4,2X13 TCB INOX	10	PZ	VL1005A1	VASCA SIFON	2	PZ	VL1006A0	COPERCHIO SIFONE	2	PZ	VL1046A1	PORTAGOMM A D6-CODOLO D6	7	PZ	VL1047A1	PORTAGOMM A D6 CODOLO D8	2	PZ	VL1047A2	PORTAGOMM A D6 CODOLO D8	2	PZ
Codice	Descrizione	Qtà	UM																																																																																						
RC1008A0	FASCETTA ELASTICA D9 ZINCATA	7	PZ																																																																																						
RC1055A0	FASCETTA STRINGI TUBO Ø25-40 H12 INOX	10	PZ																																																																																						
RC1297A0	RACCORDO A T Ø10	1	PZ																																																																																						
RC1297A1	RACCORDO A T Ø10	1	PZ																																																																																						
RC1360A0	RACCORDO GOMITO JG 10-10	1	PZ																																																																																						
RC1376A0	RACCORDO Y Ø6	1	PZ																																																																																						
TB1177A0	PIEDE QUADRO 40X40 H58 SOVRAP. LM	4	PZ																																																																																						
TB1520A0	TUBO D.INT=30 SP=4 GOMMA EPDM NERO	2.700	M																																																																																						
TB1815A0	TUBO PE 7,93X4,75 TRASPARENT	2	M																																																																																						
TB2243A0	TUBO PET Ø10	1.500	M																																																																																						
VI1075A0	DADO M4 H=4 INOX UNI5587	8	PZ																																																																																						
VI1220A1	VITE AUTOFILETTA NTE 4.2X11 TCS+ MARUTE	16	PZ																																																																																						
VI1895A0	DADO CIECO M4 INOX DIN 917	8	PZ																																																																																						
VI1945A0	VITE M4X20 TCB+ INOX	8	PZ																																																																																						
VI1950A0	VITE AUTOFORANT E 4,2X13 TCB INOX	10	PZ																																																																																						
VL1005A1	VASCA SIFON	2	PZ																																																																																						
VL1006A0	COPERCHIO SIFONE	2	PZ																																																																																						
VL1046A1	PORTAGOMM A D6-CODOLO D6	7	PZ																																																																																						
VL1047A1	PORTAGOMM A D6 CODOLO D8	2	PZ																																																																																						
VL1047A2	PORTAGOMM A D6 CODOLO D8	2	PZ																																																																																						

COMPONENTE			RICAMBIO																		
Codice	Descrizione	Immagine	Codice	Descrizione	Lista componenti																
VL1006A	COPERCHIO SIFON		XC648	KIT SOVRAPPOSIZIONE LM TOP 800	<table border="1"> <thead> <tr> <th>Codice</th> <th>Descrizione</th> <th>Qtà</th> <th>UM</th> </tr> </thead> <tbody> <tr> <td>VM1015A1</td> <td>CURVA A 90° INOX Ø30X1</td> <td>1</td> <td>PZ</td> </tr> <tr> <td>VM1794A0</td> <td>FASCETTA 250X4.8 PA66 NERA</td> <td>2</td> <td>PZ</td> </tr> <tr> <td>VM2035A0</td> <td>SUPPORTO PER TUBO DI SCARICO</td> <td>1</td> <td>PZ</td> </tr> </tbody> </table>	Codice	Descrizione	Qtà	UM	VM1015A1	CURVA A 90° INOX Ø30X1	1	PZ	VM1794A0	FASCETTA 250X4.8 PA66 NERA	2	PZ	VM2035A0	SUPPORTO PER TUBO DI SCARICO	1	PZ
Codice	Descrizione	Qtà	UM																		
VM1015A1	CURVA A 90° INOX Ø30X1	1	PZ																		
VM1794A0	FASCETTA 250X4.8 PA66 NERA	2	PZ																		
VM2035A0	SUPPORTO PER TUBO DI SCARICO	1	PZ																		
VM2036A	SUPPORTO TUBO SCARICO ACQUA		KVM2036A	KIT SUPPORTO TUBO SCARICO ACQUA	<table border="1"> <thead> <tr> <th>Codice</th> <th>Descrizione</th> <th>Qtà</th> <th>UM</th> </tr> </thead> <tbody> <tr> <td>VH1220A1</td> <td>VITE AUTOFILETTA NTE 4.2X11 TCS+ MARUTE</td> <td>2</td> <td>PZ</td> </tr> <tr> <td>VM2036A0</td> <td>SUPPORTO TUBO SCARICO ACQUA</td> <td>2</td> <td>PZ</td> </tr> </tbody> </table>	Codice	Descrizione	Qtà	UM	VH1220A1	VITE AUTOFILETTA NTE 4.2X11 TCS+ MARUTE	2	PZ	VM2036A0	SUPPORTO TUBO SCARICO ACQUA	2	PZ				
Codice	Descrizione	Qtà	UM																		
VH1220A1	VITE AUTOFILETTA NTE 4.2X11 TCS+ MARUTE	2	PZ																		
VM2036A0	SUPPORTO TUBO SCARICO ACQUA	2	PZ																		
TB2939A	TUBO SCARICO ACQUA XEVC-2011		TB2939A0	TUBO SCARICO ACQUA XEVC-2011																	
0H6567A	LAMIERA SOSTEGNO SIFONE		0H6567A0	LAMIERA SOSTEGNO SIFONE																	
0D2312A	FIANCO SX XEVC-2011		0D2312A0	FIANCO SX XEVC-2011																	



COMPONENTE			RICAMBIO																																																																		
Codice	Descrizione	Immagine	Codice	Descrizione	Lista componenti																																																																
VE1295A	MICROINTERRUTTORE PORTA MK 16A 230V UL		KVE1295A	KIT MICROINTERRUTTORE PORTA 16A 230V	<table border="1"> <thead> <tr> <th>Codice</th> <th>Descrizione</th> <th>Qtà</th> <th>UM</th> </tr> </thead> <tbody> <tr> <td>VE1295A0</td> <td>MICROINTERRUTTORE PORTA MK 16A 230V UL</td> <td>1</td> <td>PZ</td> </tr> </tbody> </table>	Codice	Descrizione	Qtà	UM	VE1295A0	MICROINTERRUTTORE PORTA MK 16A 230V UL	1	PZ																																																								
Codice	Descrizione	Qtà	UM																																																																		
VE1295A0	MICROINTERRUTTORE PORTA MK 16A 230V UL	1	PZ																																																																		
SB1015A	SERBATOIO DETERGENTE 4L + ROMPI-CIALDA		XUC060	KIT TANICA DETERGENTE PER LIEVITATORE	<table border="1"> <thead> <tr> <th>Codice</th> <th>Descrizione</th> <th>Qtà</th> <th>UM</th> </tr> </thead> <tbody> <tr> <td>0H7558B0</td> <td>GUIDA TANICA DETERGENTE</td> <td>1</td> <td>PZ</td> </tr> <tr> <td>0H7559B0</td> <td>FRONTALINO KIT TANICA</td> <td>2</td> <td>PZ</td> </tr> <tr> <td>0H7656A0</td> <td>GUIDA TANICA DETERGENTE</td> <td>1</td> <td>PZ</td> </tr> <tr> <td>0H7657A0</td> <td>FRONTALINO KIT TANICA</td> <td>2</td> <td>PZ</td> </tr> <tr> <td>CE1016A0</td> <td>TERMINALE AD OCCHIELLO D=4,3 MM</td> <td>2</td> <td>PZ</td> </tr> <tr> <td>CE1630A1</td> <td>CAVO UNIP AWG16 ST.3135 NERO</td> <td>0.680</td> <td>M</td> </tr> <tr> <td>EL1220A0</td> <td>RACCORDO DRITTO Ø8F-Ø8F</td> <td>1</td> <td>PZ</td> </tr> <tr> <td>IP1385A1</td> <td>IMB POL ANGOLARE 110X80X2000 D30</td> <td>3.520</td> <td>M</td> </tr> <tr> <td>RC1019A0</td> <td>FASCETTA ELASTICA D10 ZINCATA</td> <td>2</td> <td>PZ</td> </tr> <tr> <td>SB1015A1</td> <td>SERBATOIO DETERGENTE 4L + ROMPI-CIALDA</td> <td>1</td> <td>PZ</td> </tr> <tr> <td>TB2820A0</td> <td>TUBO EPDM 6X10</td> <td>2</td> <td>M</td> </tr> <tr> <td>VI1220A1</td> <td>VITE AUTOFILETTA NTE 4.2X11 TCS+ MARUTE</td> <td>9</td> <td>PZ</td> </tr> <tr> <td>VI1225A0</td> <td>RIVETTO STRUTT. 4X10.1 INOX</td> <td>8</td> <td>PZ</td> </tr> <tr> <td>VI1950A0</td> <td>VITE AUTOFORANTE E 4,2X13 TCB INOX</td> <td>4</td> <td>PZ</td> </tr> <tr> <td>VL1047A1</td> <td>PORTAGOMMA A D6 CODOLO D8</td> <td>2</td> <td>PZ</td> </tr> </tbody> </table>	Codice	Descrizione	Qtà	UM	0H7558B0	GUIDA TANICA DETERGENTE	1	PZ	0H7559B0	FRONTALINO KIT TANICA	2	PZ	0H7656A0	GUIDA TANICA DETERGENTE	1	PZ	0H7657A0	FRONTALINO KIT TANICA	2	PZ	CE1016A0	TERMINALE AD OCCHIELLO D=4,3 MM	2	PZ	CE1630A1	CAVO UNIP AWG16 ST.3135 NERO	0.680	M	EL1220A0	RACCORDO DRITTO Ø8F-Ø8F	1	PZ	IP1385A1	IMB POL ANGOLARE 110X80X2000 D30	3.520	M	RC1019A0	FASCETTA ELASTICA D10 ZINCATA	2	PZ	SB1015A1	SERBATOIO DETERGENTE 4L + ROMPI-CIALDA	1	PZ	TB2820A0	TUBO EPDM 6X10	2	M	VI1220A1	VITE AUTOFILETTA NTE 4.2X11 TCS+ MARUTE	9	PZ	VI1225A0	RIVETTO STRUTT. 4X10.1 INOX	8	PZ	VI1950A0	VITE AUTOFORANTE E 4,2X13 TCB INOX	4	PZ	VL1047A1	PORTAGOMMA A D6 CODOLO D8	2	PZ
Codice	Descrizione	Qtà	UM																																																																		
0H7558B0	GUIDA TANICA DETERGENTE	1	PZ																																																																		
0H7559B0	FRONTALINO KIT TANICA	2	PZ																																																																		
0H7656A0	GUIDA TANICA DETERGENTE	1	PZ																																																																		
0H7657A0	FRONTALINO KIT TANICA	2	PZ																																																																		
CE1016A0	TERMINALE AD OCCHIELLO D=4,3 MM	2	PZ																																																																		
CE1630A1	CAVO UNIP AWG16 ST.3135 NERO	0.680	M																																																																		
EL1220A0	RACCORDO DRITTO Ø8F-Ø8F	1	PZ																																																																		
IP1385A1	IMB POL ANGOLARE 110X80X2000 D30	3.520	M																																																																		
RC1019A0	FASCETTA ELASTICA D10 ZINCATA	2	PZ																																																																		
SB1015A1	SERBATOIO DETERGENTE 4L + ROMPI-CIALDA	1	PZ																																																																		
TB2820A0	TUBO EPDM 6X10	2	M																																																																		
VI1220A1	VITE AUTOFILETTA NTE 4.2X11 TCS+ MARUTE	9	PZ																																																																		
VI1225A0	RIVETTO STRUTT. 4X10.1 INOX	8	PZ																																																																		
VI1950A0	VITE AUTOFORANTE E 4,2X13 TCB INOX	4	PZ																																																																		
VL1047A1	PORTAGOMMA A D6 CODOLO D8	2	PZ																																																																		



COMPONENTE			RICAMBIO																						
Codice	Descrizione	Immagine	Codice	Descrizione	Lista componenti																				
SB1015A	SERBATOIO DETERGENTE 4L + ROMPI-CIALDA		XUC060	KIT TANICA DETERGENTE PER LIEVITATORE	<table border="1"> <thead> <tr> <th>Codice</th> <th>Descrizione</th> <th>Qtà</th> <th>UM</th> </tr> </thead> <tbody> <tr> <td>VL1047A2</td> <td>PORTAGOMM A D6 CODOLO D8</td> <td>2</td> <td>PZ</td> </tr> <tr> <td>VM1059A1</td> <td>FILM TERMORETRA IBILE H800</td> <td>2</td> <td>M</td> </tr> <tr> <td>VM1197A0</td> <td>CORNICE SERBATOIO DET. MM BIG</td> <td>2</td> <td>PZ</td> </tr> <tr> <td>VM1198A0</td> <td>CLIP BLOCCA CORNICE SERBATOIO DET. MM</td> <td>8</td> <td>PZ</td> </tr> </tbody> </table>	Codice	Descrizione	Qtà	UM	VL1047A2	PORTAGOMM A D6 CODOLO D8	2	PZ	VM1059A1	FILM TERMORETRA IBILE H800	2	M	VM1197A0	CORNICE SERBATOIO DET. MM BIG	2	PZ	VM1198A0	CLIP BLOCCA CORNICE SERBATOIO DET. MM	8	PZ
			Codice	Descrizione	Qtà	UM																			
VL1047A2	PORTAGOMM A D6 CODOLO D8	2	PZ																						
VM1059A1	FILM TERMORETRA IBILE H800	2	M																						
VM1197A0	CORNICE SERBATOIO DET. MM BIG	2	PZ																						
VM1198A0	CLIP BLOCCA CORNICE SERBATOIO DET. MM	8	PZ																						
KSB1015A	KIT SERBATOIO DETERGENTE 4L	<table border="1"> <thead> <tr> <th>Codice</th> <th>Descrizione</th> <th>Qtà</th> <th>UM</th> </tr> </thead> <tbody> <tr> <td>IP1385A1</td> <td>IMB POL ANGOLARE 110X80X2000 D30</td> <td>1.200</td> <td>M</td> </tr> <tr> <td>IP1410A0</td> <td>IMB POL SALVAVETRO 300X300X8 D1</td> <td>2</td> <td>PZ</td> </tr> <tr> <td>SB1015A1</td> <td>SERBATOIO DETERGENTE 4L + ROMPI-CIALD</td> <td>1</td> <td>PZ</td> </tr> <tr> <td>VM1059A1</td> <td>FILM TERMORETRA IBILE H800</td> <td>1.200</td> <td>M</td> </tr> </tbody> </table>	Codice	Descrizione	Qtà	UM	IP1385A1	IMB POL ANGOLARE 110X80X2000 D30	1.200	M	IP1410A0	IMB POL SALVAVETRO 300X300X8 D1	2	PZ	SB1015A1	SERBATOIO DETERGENTE 4L + ROMPI-CIALD	1	PZ	VM1059A1	FILM TERMORETRA IBILE H800	1.200	M			
Codice	Descrizione	Qtà	UM																						
IP1385A1	IMB POL ANGOLARE 110X80X2000 D30	1.200	M																						
IP1410A0	IMB POL SALVAVETRO 300X300X8 D1	2	PZ																						
SB1015A1	SERBATOIO DETERGENTE 4L + ROMPI-CIALD	1	PZ																						
VM1059A1	FILM TERMORETRA IBILE H800	1.200	M																						
0D2314A	COPERCHIO ESTERNO XEVC-2011-E		0D2314A0	COPERCHIO ESTERNO XEVC-2011-E																					
VM1240A	TAPPO NYLON SUPPORTO CONTROSTAFFA		KVM1240A	KIT TAPPO SUPPORTO CONTROSTAFFA 4P	<table border="1"> <thead> <tr> <th>Codice</th> <th>Descrizione</th> <th>Qtà</th> <th>UM</th> </tr> </thead> <tbody> <tr> <td>VM1240A0</td> <td>TAPPO NYLON SUPPORTO CONTROSTAF FA</td> <td>4</td> <td>PZ</td> </tr> </tbody> </table>	Codice	Descrizione	Qtà	UM	VM1240A0	TAPPO NYLON SUPPORTO CONTROSTAF FA	4	PZ												
Codice	Descrizione	Qtà	UM																						
VM1240A0	TAPPO NYLON SUPPORTO CONTROSTAF FA	4	PZ																						

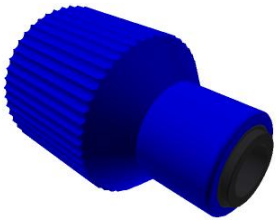

COMPONENTE			RICAMBIO																																		
Codice	Descrizione	Immagine	Codice	Descrizione	Lista componenti																																
VM2282A	PIASTRINA SUPPORTO MICROPORTA		KVM2282A	KIT PIASTRINA SUPPORTO MICROPORTA	<table border="1"> <thead> <tr> <th>Codice</th> <th>Descrizione</th> <th>Qtà</th> <th>UM</th> </tr> </thead> <tbody> <tr> <td>VM2282A0</td> <td>PIASTRINA SUPPORTO MICROPORTA</td> <td>1</td> <td>PZ</td> </tr> </tbody> </table>	Codice	Descrizione	Qtà	UM	VM2282A0	PIASTRINA SUPPORTO MICROPORTA	1	PZ																								
Codice	Descrizione	Qtà	UM																																		
VM2282A0	PIASTRINA SUPPORTO MICROPORTA	1	PZ																																		
VE1020B	MICROINT. PORTA MAGNETICO CON MINIFIT 2P		KVE1020B	KIT MICROPORTA	<table border="1"> <thead> <tr> <th>Codice</th> <th>Descrizione</th> <th>Qtà</th> <th>UM</th> </tr> </thead> <tbody> <tr> <td>CE1030A0</td> <td>FASTON FEMMINA 6.3X0.8 0.5-1MMQ</td> <td>2</td> <td>PZ</td> </tr> <tr> <td>CE1660A0</td> <td>COPRI FASTON FEMMINA 6.3X0.8</td> <td>2</td> <td>PZ</td> </tr> <tr> <td>CE1730A0</td> <td>CAVO PVC NP 2 X AWG22 STYLE 2095</td> <td>0.150</td> <td>M</td> </tr> <tr> <td>CE1740A0</td> <td>TERMINALE MINIFIT MASCHIO</td> <td>2</td> <td>PZ</td> </tr> <tr> <td>CE1745A0</td> <td>CONNETTORE MINIFIT FEMMINA 2 VI</td> <td>1</td> <td>PZ</td> </tr> <tr> <td>VE1020B0</td> <td>MICROINT. PORTA MAGNETICO CON MINIFIT 2</td> <td>1</td> <td>PZ</td> </tr> <tr> <td>VE1030A1</td> <td>CALAMITA D=22,9MM PER MICROPORTA</td> <td>1</td> <td>PZ</td> </tr> </tbody> </table>	Codice	Descrizione	Qtà	UM	CE1030A0	FASTON FEMMINA 6.3X0.8 0.5-1MMQ	2	PZ	CE1660A0	COPRI FASTON FEMMINA 6.3X0.8	2	PZ	CE1730A0	CAVO PVC NP 2 X AWG22 STYLE 2095	0.150	M	CE1740A0	TERMINALE MINIFIT MASCHIO	2	PZ	CE1745A0	CONNETTORE MINIFIT FEMMINA 2 VI	1	PZ	VE1020B0	MICROINT. PORTA MAGNETICO CON MINIFIT 2	1	PZ	VE1030A1	CALAMITA D=22,9MM PER MICROPORTA	1	PZ
Codice	Descrizione	Qtà	UM																																		
CE1030A0	FASTON FEMMINA 6.3X0.8 0.5-1MMQ	2	PZ																																		
CE1660A0	COPRI FASTON FEMMINA 6.3X0.8	2	PZ																																		
CE1730A0	CAVO PVC NP 2 X AWG22 STYLE 2095	0.150	M																																		
CE1740A0	TERMINALE MINIFIT MASCHIO	2	PZ																																		
CE1745A0	CONNETTORE MINIFIT FEMMINA 2 VI	1	PZ																																		
VE1020B0	MICROINT. PORTA MAGNETICO CON MINIFIT 2	1	PZ																																		
VE1030A1	CALAMITA D=22,9MM PER MICROPORTA	1	PZ																																		
0H2561A	CONTROSTAFFA PORTA MM		0H2561A0	CONTROSTAFFA PORTA MM																																	

COMPONENTE			RICAMBIO																														
Codice	Descrizione	Immagine	Codice	Descrizione	Lista componenti																												
VI1995A	VITE M5X25 TCEI INOX		VI1995A0	VITE M5X25 TCEI INOX																													
VM2352A	TAPPO SX COPRI VITI STAFFA PORTA INF MM		VM2352A0	TAPPO SX COPRI VITI STAFFA PORTA INF MM																													
VM2353A	TAPPO DX COPRI VITI STAFFA PORTA INF MM		VM2353A0	TAPPO DX COPRI VITI STAFFA PORTA INF MM																													
VM1240A	TAPPO NYLON SUPPORTO CONTROSTAFFA		KVM1240A	KIT TAPPO SUPPORTO CONTROSTAFFA 4P	<table border="1"> <thead> <tr> <th>Codice</th> <th>Descrizione</th> <th>Qtà</th> <th>UM</th> </tr> </thead> <tbody> <tr> <td>VM1240A0</td> <td>TAPPO NYLON SUPPORTO CONTROSTAFFA FA</td> <td>4</td> <td>PZ</td> </tr> </tbody> </table>	Codice	Descrizione	Qtà	UM	VM1240A0	TAPPO NYLON SUPPORTO CONTROSTAFFA FA	4	PZ																				
Codice	Descrizione	Qtà	UM																														
VM1240A0	TAPPO NYLON SUPPORTO CONTROSTAFFA FA	4	PZ																														
VM2273A	STAFFA INF PORTA MM SX		KVM2273A	KIT STAFFA INFERIORE PORTA MIND.MAPS SX	<table border="1"> <thead> <tr> <th>Codice</th> <th>Descrizione</th> <th>Qtà</th> <th>UM</th> </tr> </thead> <tbody> <tr> <td>0H7330A0</td> <td>RONDELLA STAFFA INFERIORE PORTA MM</td> <td>2</td> <td>PZ</td> </tr> <tr> <td>VI1995A0</td> <td>VITE M5X25 TCEI INOX</td> <td>4</td> <td>PZ</td> </tr> <tr> <td>VM2273A0</td> <td>STAFFA INF PORTA MM SX</td> <td>1</td> <td>PZ</td> </tr> <tr> <td>VM2273A1</td> <td>STAFFA INF PORTA MM SX</td> <td>1</td> <td>PZ</td> </tr> <tr> <td>VM2352A0</td> <td>TAPPO SX COPRI VITI STAFFA PORTA INF M</td> <td>2</td> <td>PZ</td> </tr> <tr> <td>VM2353A0</td> <td>TAPPO DX COPRI VITI STAFFA PORTA INF M</td> <td>1</td> <td>PZ</td> </tr> </tbody> </table>	Codice	Descrizione	Qtà	UM	0H7330A0	RONDELLA STAFFA INFERIORE PORTA MM	2	PZ	VI1995A0	VITE M5X25 TCEI INOX	4	PZ	VM2273A0	STAFFA INF PORTA MM SX	1	PZ	VM2273A1	STAFFA INF PORTA MM SX	1	PZ	VM2352A0	TAPPO SX COPRI VITI STAFFA PORTA INF M	2	PZ	VM2353A0	TAPPO DX COPRI VITI STAFFA PORTA INF M	1	PZ
Codice	Descrizione	Qtà	UM																														
0H7330A0	RONDELLA STAFFA INFERIORE PORTA MM	2	PZ																														
VI1995A0	VITE M5X25 TCEI INOX	4	PZ																														
VM2273A0	STAFFA INF PORTA MM SX	1	PZ																														
VM2273A1	STAFFA INF PORTA MM SX	1	PZ																														
VM2352A0	TAPPO SX COPRI VITI STAFFA PORTA INF M	2	PZ																														
VM2353A0	TAPPO DX COPRI VITI STAFFA PORTA INF M	1	PZ																														

COMPONENTE			RICAMBIO																										
Codice	Descrizione	Immagine	Codice	Descrizione	Lista componenti																								
0H2561A	CONTROSTAFFA PORTA MM		0H2561A0	CONTROSTAFFA PORTA MM																									
VI1995A	VITE M5X25 TCEI INOX		VI1995A0	VITE M5X25 TCEI INOX																									
VM1240A	TAPPO NYLON SUPPORTO CONTROSTAFFA		KVM1240A	KIT TAPPO SUPPORTO CONTROSTAFFA 4P	<table border="1"> <thead> <tr> <th>Codice</th> <th>Descrizione</th> <th>Qtà</th> <th>UM</th> </tr> </thead> <tbody> <tr> <td>VM1240A0</td> <td>TAPPO NYLON SUPPORTO CONTROSTAF FA</td> <td>4</td> <td>PZ</td> </tr> </tbody> </table>	Codice	Descrizione	Qtà	UM	VM1240A0	TAPPO NYLON SUPPORTO CONTROSTAF FA	4	PZ																
Codice	Descrizione	Qtà	UM																										
VM1240A0	TAPPO NYLON SUPPORTO CONTROSTAF FA	4	PZ																										
VM2298A	COPERCHIO SUP STAFFA PORTA MM		KVM2298A	KIT COPERCHIO SUP STAFFA PORTA MIND MAPS	<table border="1"> <thead> <tr> <th>Codice</th> <th>Descrizione</th> <th>Qtà</th> <th>UM</th> </tr> </thead> <tbody> <tr> <td>VI1220A0</td> <td>VITE AUTOFIL. 4.2X12 TCB MARUTEX PREMAGN</td> <td>2</td> <td>PZ</td> </tr> <tr> <td>VM2298A0</td> <td>COPERCHIO SUP STAFFA PORTA MM</td> <td>1</td> <td>PZ</td> </tr> </tbody> </table>	Codice	Descrizione	Qtà	UM	VI1220A0	VITE AUTOFIL. 4.2X12 TCB MARUTEX PREMAGN	2	PZ	VM2298A0	COPERCHIO SUP STAFFA PORTA MM	1	PZ												
Codice	Descrizione	Qtà	UM																										
VI1220A0	VITE AUTOFIL. 4.2X12 TCB MARUTEX PREMAGN	2	PZ																										
VM2298A0	COPERCHIO SUP STAFFA PORTA MM	1	PZ																										
VM2271A	STAFFA SUP PORTA MM SX		KVM2271A	KIT STAFFA SUPERIORE PORTA MIND.MAPS SX	<table border="1"> <thead> <tr> <th>Codice</th> <th>Descrizione</th> <th>Qtà</th> <th>UM</th> </tr> </thead> <tbody> <tr> <td>VI1220A1</td> <td>VITE AUTOFILETTA NTE 4.2X11 TCS+ MARUTE</td> <td>2</td> <td>PZ</td> </tr> <tr> <td>VI1995A0</td> <td>VITE M5X25 TCEI INOX</td> <td>4</td> <td>PZ</td> </tr> <tr> <td>VI1997A0</td> <td>RONDELLA PIANA 5X10X1 ZN</td> <td>4</td> <td>PZ</td> </tr> <tr> <td>VM2271A0</td> <td>STAFFA SUP PORTA MM SX</td> <td>1</td> <td>PZ</td> </tr> <tr> <td>VM2298A0</td> <td>COPERCHIO SUP STAFFA PORTA MM</td> <td>1</td> <td>PZ</td> </tr> </tbody> </table>	Codice	Descrizione	Qtà	UM	VI1220A1	VITE AUTOFILETTA NTE 4.2X11 TCS+ MARUTE	2	PZ	VI1995A0	VITE M5X25 TCEI INOX	4	PZ	VI1997A0	RONDELLA PIANA 5X10X1 ZN	4	PZ	VM2271A0	STAFFA SUP PORTA MM SX	1	PZ	VM2298A0	COPERCHIO SUP STAFFA PORTA MM	1	PZ
Codice	Descrizione	Qtà	UM																										
VI1220A1	VITE AUTOFILETTA NTE 4.2X11 TCS+ MARUTE	2	PZ																										
VI1995A0	VITE M5X25 TCEI INOX	4	PZ																										
VI1997A0	RONDELLA PIANA 5X10X1 ZN	4	PZ																										
VM2271A0	STAFFA SUP PORTA MM SX	1	PZ																										
VM2298A0	COPERCHIO SUP STAFFA PORTA MM	1	PZ																										

COMPONENTE			RICAMBIO																																										
Codice	Descrizione	Immagine	Codice	Descrizione	Lista componenti																																								
RC1365A	RACCORDO JG FEMMINA 3/4"-10		KRC1365A	KIT RICAMBIO ATTACCO ACQUA DI RETE	<table border="1"> <thead> <tr> <th>Codice</th> <th>Descrizione</th> <th>Qtà</th> <th>UM</th> </tr> </thead> <tbody> <tr> <td>GN1200A1</td> <td>GUARNIZIONE D24 RACCORDO 3/4 SILICONE</td> <td>1</td> <td>PZ</td> </tr> <tr> <td>RC1002A0</td> <td>RACCORDO RIDUZIONE CODOLO 10M-8F</td> <td>1</td> <td>PZ</td> </tr> <tr> <td>RC1365A0</td> <td>RACCORDO JG FEMMINA 3/4"-10</td> <td>1</td> <td>PZ</td> </tr> </tbody> </table>	Codice	Descrizione	Qtà	UM	GN1200A1	GUARNIZIONE D24 RACCORDO 3/4 SILICONE	1	PZ	RC1002A0	RACCORDO RIDUZIONE CODOLO 10M-8F	1	PZ	RC1365A0	RACCORDO JG FEMMINA 3/4"-10	1	PZ																								
Codice	Descrizione	Qtà	UM																																										
GN1200A1	GUARNIZIONE D24 RACCORDO 3/4 SILICONE	1	PZ																																										
RC1002A0	RACCORDO RIDUZIONE CODOLO 10M-8F	1	PZ																																										
RC1365A0	RACCORDO JG FEMMINA 3/4"-10	1	PZ																																										
VL1086A	MAGNETE NEODIMIO ANTICALCARE		KVL1086A	KIT MAGNETE NEODIMIO ANTICALCARE	<table border="1"> <thead> <tr> <th>Codice</th> <th>Descrizione</th> <th>Qtà</th> <th>UM</th> </tr> </thead> <tbody> <tr> <td>VL1086A0</td> <td>MAGNETE NEODIMIO ANTICALCARE</td> <td>2</td> <td>PZ</td> </tr> </tbody> </table>	Codice	Descrizione	Qtà	UM	VL1086A0	MAGNETE NEODIMIO ANTICALCARE	2	PZ																																
Codice	Descrizione	Qtà	UM																																										
VL1086A0	MAGNETE NEODIMIO ANTICALCARE	2	PZ																																										
VM1054A	GHIERA RIDUTTORE DI PRESSIONE H7.8		KVM1054A KVL1117A	KIT GHIERA RIDUTTORE DI PRESSIONE KIT FILTRO+RID. PRESS. EUR MM 2016+LMTOP	<table border="1"> <thead> <tr> <th>Codice</th> <th>Descrizione</th> <th>Qtà</th> <th>UM</th> </tr> </thead> <tbody> <tr> <td>VM1054A0</td> <td>GHIERA RIDUTTORE DI PRESSIONE H7.8</td> <td>1</td> <td>PZ</td> </tr> </tbody> </table> <table border="1"> <thead> <tr> <th>Codice</th> <th>Descrizione</th> <th>Qtà</th> <th>UM</th> </tr> </thead> <tbody> <tr> <td>0H7472A1</td> <td>LAMIERA SUPPORTO DISTRIBUTOR</td> <td>1</td> <td>PZ</td> </tr> <tr> <td>RC1004A0</td> <td>RACCORDO Y Ø10-Ø8-8</td> <td>1</td> <td>PZ</td> </tr> <tr> <td>RC1243A0</td> <td>RACCORDO GOMITO CODOLO Ø10F-Ø10M</td> <td>1</td> <td>PZ</td> </tr> <tr> <td>RC1372A0</td> <td>RACCORDO DRITTO Ø10M-1/4 M CI</td> <td>2</td> <td>PZ</td> </tr> <tr> <td>VI1013A1</td> <td>RONDELLA PIANA 30.5X39.5X3 NYLON</td> <td>1</td> <td>PZ</td> </tr> <tr> <td>VI1220A1</td> <td>VITE AUTOFILETTA NTE 4.2X11 TCS+ MARUTE</td> <td>2</td> <td>PZ</td> </tr> <tr> <td>VL1014A0</td> <td>RIDUTTORE DI PRESSIONE CON DISTRIBUTOR</td> <td>1</td> <td>PZ</td> </tr> </tbody> </table>	Codice	Descrizione	Qtà	UM	VM1054A0	GHIERA RIDUTTORE DI PRESSIONE H7.8	1	PZ	Codice	Descrizione	Qtà	UM	0H7472A1	LAMIERA SUPPORTO DISTRIBUTOR	1	PZ	RC1004A0	RACCORDO Y Ø10-Ø8-8	1	PZ	RC1243A0	RACCORDO GOMITO CODOLO Ø10F-Ø10M	1	PZ	RC1372A0	RACCORDO DRITTO Ø10M-1/4 M CI	2	PZ	VI1013A1	RONDELLA PIANA 30.5X39.5X3 NYLON	1	PZ	VI1220A1	VITE AUTOFILETTA NTE 4.2X11 TCS+ MARUTE	2	PZ	VL1014A0	RIDUTTORE DI PRESSIONE CON DISTRIBUTOR	1	PZ
Codice	Descrizione	Qtà	UM																																										
VM1054A0	GHIERA RIDUTTORE DI PRESSIONE H7.8	1	PZ																																										
Codice	Descrizione	Qtà	UM																																										
0H7472A1	LAMIERA SUPPORTO DISTRIBUTOR	1	PZ																																										
RC1004A0	RACCORDO Y Ø10-Ø8-8	1	PZ																																										
RC1243A0	RACCORDO GOMITO CODOLO Ø10F-Ø10M	1	PZ																																										
RC1372A0	RACCORDO DRITTO Ø10M-1/4 M CI	2	PZ																																										
VI1013A1	RONDELLA PIANA 30.5X39.5X3 NYLON	1	PZ																																										
VI1220A1	VITE AUTOFILETTA NTE 4.2X11 TCS+ MARUTE	2	PZ																																										
VL1014A0	RIDUTTORE DI PRESSIONE CON DISTRIBUTOR	1	PZ																																										

COMPONENTE			RICAMBIO																																																						
Codice	Descrizione	Immagine	Codice	Descrizione	Lista componenti																																																				
VM1054A	GHIERA RIDUTTORE DI PRESSIONE H7.8		KVL1117A	KIT FILTRO+RID. PRESS. EUR MM 2016+LMTOP	<table border="1"> <thead> <tr> <th>Codice</th> <th>Descrizione</th> <th>Qtà</th> <th>UM</th> </tr> </thead> <tbody> <tr> <td>VL1014B0</td> <td>RIDUTTORE DI PRESSIONE CON DISTRIBUTOR</td> <td>1</td> <td>PZ</td> </tr> <tr> <td>VL1034C0</td> <td>FILTRO ACQUA D10 MESH100</td> <td>1</td> <td>PZ</td> </tr> <tr> <td>VL1062C0</td> <td>FORCELLA BLOCCA FILTRO-RIDUTTORE PRES.</td> <td>1</td> <td>PZ</td> </tr> <tr> <td>VM1053A0</td> <td>TAPPO 1/8" CIL CON O-RIN</td> <td>2</td> <td>PZ</td> </tr> <tr> <td>VM1054A0</td> <td>GHIERA RIDUTTORE DI PRESSIONE H7.8</td> <td>1</td> <td>PZ</td> </tr> </tbody> </table>	Codice	Descrizione	Qtà	UM	VL1014B0	RIDUTTORE DI PRESSIONE CON DISTRIBUTOR	1	PZ	VL1034C0	FILTRO ACQUA D10 MESH100	1	PZ	VL1062C0	FORCELLA BLOCCA FILTRO-RIDUTTORE PRES.	1	PZ	VM1053A0	TAPPO 1/8" CIL CON O-RIN	2	PZ	VM1054A0	GHIERA RIDUTTORE DI PRESSIONE H7.8	1	PZ																												
Codice	Descrizione	Qtà	UM																																																						
VL1014B0	RIDUTTORE DI PRESSIONE CON DISTRIBUTOR	1	PZ																																																						
VL1034C0	FILTRO ACQUA D10 MESH100	1	PZ																																																						
VL1062C0	FORCELLA BLOCCA FILTRO-RIDUTTORE PRES.	1	PZ																																																						
VM1053A0	TAPPO 1/8" CIL CON O-RIN	2	PZ																																																						
VM1054A0	GHIERA RIDUTTORE DI PRESSIONE H7.8	1	PZ																																																						
VL1034C	FILTRO ACQUA D10 MESH100		KVL1117A	KIT FILTRO+RID. PRESS. EUR MM 2016+LMTOP	<table border="1"> <thead> <tr> <th>Codice</th> <th>Descrizione</th> <th>Qtà</th> <th>UM</th> </tr> </thead> <tbody> <tr> <td>0H7472A1</td> <td>LAMIERA SUPPORTO DISTRIBUTOR</td> <td>1</td> <td>PZ</td> </tr> <tr> <td>RC1004A0</td> <td>RACCORDO Y Ø10-Ø8-8</td> <td>1</td> <td>PZ</td> </tr> <tr> <td>RC1243A0</td> <td>RACCORDO GOMITO CODOLO Ø10F-Ø10M</td> <td>1</td> <td>PZ</td> </tr> <tr> <td>RC1372A0</td> <td>RACCORDO DRITTO Ø10M-1/4 M.CI</td> <td>2</td> <td>PZ</td> </tr> <tr> <td>VI1013A1</td> <td>RONDELLA PIANA 30.5X39.5X3 NYLON</td> <td>1</td> <td>PZ</td> </tr> <tr> <td>VI1220A1</td> <td>VITE AUTOFILETTA NTE 4.2X11 TCS+ MARUTE</td> <td>2</td> <td>PZ</td> </tr> <tr> <td>VL1014A0</td> <td>RIDUTTORE DI PRESSIONE CON DISTRIBUTOR</td> <td>1</td> <td>PZ</td> </tr> <tr> <td>VL1014B0</td> <td>RIDUTTORE DI PRESSIONE CON DISTRIBUTOR</td> <td>1</td> <td>PZ</td> </tr> <tr> <td>VL1034C0</td> <td>FILTRO ACQUA D10 MESH100</td> <td>1</td> <td>PZ</td> </tr> <tr> <td>VL1062C0</td> <td>FORCELLA BLOCCA FILTRO-RIDUTTORE PRES.</td> <td>1</td> <td>PZ</td> </tr> <tr> <td>VM1053A0</td> <td>TAPPO 1/8" CIL CON O-RIN</td> <td>2</td> <td>PZ</td> </tr> <tr> <td>VM1054A0</td> <td>GHIERA RIDUTTORE DI PRESSIONE H7.8</td> <td>1</td> <td>PZ</td> </tr> </tbody> </table>	Codice	Descrizione	Qtà	UM	0H7472A1	LAMIERA SUPPORTO DISTRIBUTOR	1	PZ	RC1004A0	RACCORDO Y Ø10-Ø8-8	1	PZ	RC1243A0	RACCORDO GOMITO CODOLO Ø10F-Ø10M	1	PZ	RC1372A0	RACCORDO DRITTO Ø10M-1/4 M.CI	2	PZ	VI1013A1	RONDELLA PIANA 30.5X39.5X3 NYLON	1	PZ	VI1220A1	VITE AUTOFILETTA NTE 4.2X11 TCS+ MARUTE	2	PZ	VL1014A0	RIDUTTORE DI PRESSIONE CON DISTRIBUTOR	1	PZ	VL1014B0	RIDUTTORE DI PRESSIONE CON DISTRIBUTOR	1	PZ	VL1034C0	FILTRO ACQUA D10 MESH100	1	PZ	VL1062C0	FORCELLA BLOCCA FILTRO-RIDUTTORE PRES.	1	PZ	VM1053A0	TAPPO 1/8" CIL CON O-RIN	2	PZ	VM1054A0	GHIERA RIDUTTORE DI PRESSIONE H7.8	1	PZ
Codice	Descrizione	Qtà	UM																																																						
0H7472A1	LAMIERA SUPPORTO DISTRIBUTOR	1	PZ																																																						
RC1004A0	RACCORDO Y Ø10-Ø8-8	1	PZ																																																						
RC1243A0	RACCORDO GOMITO CODOLO Ø10F-Ø10M	1	PZ																																																						
RC1372A0	RACCORDO DRITTO Ø10M-1/4 M.CI	2	PZ																																																						
VI1013A1	RONDELLA PIANA 30.5X39.5X3 NYLON	1	PZ																																																						
VI1220A1	VITE AUTOFILETTA NTE 4.2X11 TCS+ MARUTE	2	PZ																																																						
VL1014A0	RIDUTTORE DI PRESSIONE CON DISTRIBUTOR	1	PZ																																																						
VL1014B0	RIDUTTORE DI PRESSIONE CON DISTRIBUTOR	1	PZ																																																						
VL1034C0	FILTRO ACQUA D10 MESH100	1	PZ																																																						
VL1062C0	FORCELLA BLOCCA FILTRO-RIDUTTORE PRES.	1	PZ																																																						
VM1053A0	TAPPO 1/8" CIL CON O-RIN	2	PZ																																																						
VM1054A0	GHIERA RIDUTTORE DI PRESSIONE H7.8	1	PZ																																																						

COMPONENTE			RICAMBIO																																																						
Codice	Descrizione	Immagine	Codice	Descrizione	Lista componenti																																																				
VL1034C	FILTRO ACQUA D10 MESH100		KVL1034C	KIT RICAMBIO FILTRO ACQUA Ø8-Ø10 MESH100	<table border="1"> <thead> <tr> <th>Codice</th> <th>Descrizione</th> <th>Qtà</th> <th>UM</th> </tr> </thead> <tbody> <tr> <td>RC1002A0</td> <td>RACCORDO RIDUZIONE CODOLO 10M-8F</td> <td>2</td> <td>PZ</td> </tr> <tr> <td>VL1034C0</td> <td>FILTRO ACQUA D10 MESH100</td> <td>1</td> <td>PZ</td> </tr> <tr> <td>VL1062C0</td> <td>FORCELLA BLOCCA FILTRO-RIDUT TORE PRES.</td> <td>1</td> <td>PZ</td> </tr> </tbody> </table>	Codice	Descrizione	Qtà	UM	RC1002A0	RACCORDO RIDUZIONE CODOLO 10M-8F	2	PZ	VL1034C0	FILTRO ACQUA D10 MESH100	1	PZ	VL1062C0	FORCELLA BLOCCA FILTRO-RIDUT TORE PRES.	1	PZ																																				
Codice	Descrizione	Qtà	UM																																																						
RC1002A0	RACCORDO RIDUZIONE CODOLO 10M-8F	2	PZ																																																						
VL1034C0	FILTRO ACQUA D10 MESH100	1	PZ																																																						
VL1062C0	FORCELLA BLOCCA FILTRO-RIDUT TORE PRES.	1	PZ																																																						
VL1062C	FORCELLA BLOCCA FILTRO-RIDUTTORE PRES.		KVL1117A	KIT FILTRO+RID. PRESS. EUR MM 2016+LMTOP	<table border="1"> <thead> <tr> <th>Codice</th> <th>Descrizione</th> <th>Qtà</th> <th>UM</th> </tr> </thead> <tbody> <tr> <td>0H7472A1</td> <td>LAMIERA SUPPORTO DISTRIBUTOR</td> <td>1</td> <td>PZ</td> </tr> <tr> <td>RC1004A0</td> <td>RACCORDO Y Ø10-Ø8-8</td> <td>1</td> <td>PZ</td> </tr> <tr> <td>RC1243A0</td> <td>RACCORDO GOMITO CODOLO Ø10F-Ø10M</td> <td>1</td> <td>PZ</td> </tr> <tr> <td>RC1372A0</td> <td>RACCORDO DRITTO Ø10M-1/4 M.CI</td> <td>2</td> <td>PZ</td> </tr> <tr> <td>VI1013A1</td> <td>RONDELLA PIANA 30.5X39.5X3 NYLON</td> <td>1</td> <td>PZ</td> </tr> <tr> <td>VI1220A1</td> <td>VITE AUTOFILETTA NTE 4.2X11 TCS+ MARUTE</td> <td>2</td> <td>PZ</td> </tr> <tr> <td>VL1014A0</td> <td>RIDUTTORE DI PRESSIONE CON DISTRIBUTOR</td> <td>1</td> <td>PZ</td> </tr> <tr> <td>VL1014B0</td> <td>RIDUTTORE DI PRESSIONE CON DISTRIBUTOR</td> <td>1</td> <td>PZ</td> </tr> <tr> <td>VL1034C0</td> <td>FILTRO ACQUA D10 MESH100</td> <td>1</td> <td>PZ</td> </tr> <tr> <td>VL1062C0</td> <td>FORCELLA BLOCCA FILTRO-RIDUT TORE PRES.</td> <td>1</td> <td>PZ</td> </tr> <tr> <td>VM1053A0</td> <td>TAPPO 1/8" CIL CON O-RIN</td> <td>2</td> <td>PZ</td> </tr> <tr> <td>VM1054A0</td> <td>GHIERA RIDUTTORE DI PRESSIONE H7.8</td> <td>1</td> <td>PZ</td> </tr> </tbody> </table>	Codice	Descrizione	Qtà	UM	0H7472A1	LAMIERA SUPPORTO DISTRIBUTOR	1	PZ	RC1004A0	RACCORDO Y Ø10-Ø8-8	1	PZ	RC1243A0	RACCORDO GOMITO CODOLO Ø10F-Ø10M	1	PZ	RC1372A0	RACCORDO DRITTO Ø10M-1/4 M.CI	2	PZ	VI1013A1	RONDELLA PIANA 30.5X39.5X3 NYLON	1	PZ	VI1220A1	VITE AUTOFILETTA NTE 4.2X11 TCS+ MARUTE	2	PZ	VL1014A0	RIDUTTORE DI PRESSIONE CON DISTRIBUTOR	1	PZ	VL1014B0	RIDUTTORE DI PRESSIONE CON DISTRIBUTOR	1	PZ	VL1034C0	FILTRO ACQUA D10 MESH100	1	PZ	VL1062C0	FORCELLA BLOCCA FILTRO-RIDUT TORE PRES.	1	PZ	VM1053A0	TAPPO 1/8" CIL CON O-RIN	2	PZ	VM1054A0	GHIERA RIDUTTORE DI PRESSIONE H7.8	1	PZ
Codice	Descrizione	Qtà	UM																																																						
0H7472A1	LAMIERA SUPPORTO DISTRIBUTOR	1	PZ																																																						
RC1004A0	RACCORDO Y Ø10-Ø8-8	1	PZ																																																						
RC1243A0	RACCORDO GOMITO CODOLO Ø10F-Ø10M	1	PZ																																																						
RC1372A0	RACCORDO DRITTO Ø10M-1/4 M.CI	2	PZ																																																						
VI1013A1	RONDELLA PIANA 30.5X39.5X3 NYLON	1	PZ																																																						
VI1220A1	VITE AUTOFILETTA NTE 4.2X11 TCS+ MARUTE	2	PZ																																																						
VL1014A0	RIDUTTORE DI PRESSIONE CON DISTRIBUTOR	1	PZ																																																						
VL1014B0	RIDUTTORE DI PRESSIONE CON DISTRIBUTOR	1	PZ																																																						
VL1034C0	FILTRO ACQUA D10 MESH100	1	PZ																																																						
VL1062C0	FORCELLA BLOCCA FILTRO-RIDUT TORE PRES.	1	PZ																																																						
VM1053A0	TAPPO 1/8" CIL CON O-RIN	2	PZ																																																						
VM1054A0	GHIERA RIDUTTORE DI PRESSIONE H7.8	1	PZ																																																						

COMPONENTE			RICAMBIO																																																						
Codice	Descrizione	Immagine	Codice	Descrizione	Lista componenti																																																				
VL1125A	RACCORDO CURVO M-M PORTAGOMMA D8- CODOLO		KVL1125A	KIT 10PZ RAC CURVO M-M PORTAG D8-COD D1	<table border="1"> <thead> <tr> <th>Codice</th> <th>Descrizione</th> <th>Qtà</th> <th>UM</th> </tr> </thead> <tbody> <tr> <td>VL1125A0</td> <td>RACCORDO CURVO M-M PORTAGOMM A D8- CODOLO</td> <td>10</td> <td>PZ</td> </tr> </tbody> </table>	Codice	Descrizione	Qtà	UM	VL1125A0	RACCORDO CURVO M-M PORTAGOMM A D8- CODOLO	10	PZ																																												
Codice	Descrizione	Qtà	UM																																																						
VL1125A0	RACCORDO CURVO M-M PORTAGOMM A D8- CODOLO	10	PZ																																																						
RC1372A	RACCORDO DRITTO Ø10M-1/4 M CIL		KVL1117A	KIT FILTRO+RID. PRESS. EUR MM 2016+LMTOP	<table border="1"> <thead> <tr> <th>Codice</th> <th>Descrizione</th> <th>Qtà</th> <th>UM</th> </tr> </thead> <tbody> <tr> <td>0H7472A1</td> <td>LAMIERA SUPPORTO DISTRIBUTOR</td> <td>1</td> <td>PZ</td> </tr> <tr> <td>RC1004A0</td> <td>RACCORDO Y Ø10-Ø8-8</td> <td>1</td> <td>PZ</td> </tr> <tr> <td>RC1243A0</td> <td>RACCORDO GOMITO CODOLO Ø10F-Ø10M</td> <td>1</td> <td>PZ</td> </tr> <tr> <td>RC1372A0</td> <td>RACCORDO DRITTO Ø10M-1/4 M.CI</td> <td>2</td> <td>PZ</td> </tr> <tr> <td>VI1013A1</td> <td>RONDELLA PIANA 30.5X39.5X3 NYLON</td> <td>1</td> <td>PZ</td> </tr> <tr> <td>VI1220A1</td> <td>VITE AUTOFILETTA NTE 4.2X11 TCS+ MARUTE</td> <td>2</td> <td>PZ</td> </tr> <tr> <td>VL1014A0</td> <td>RIDUTTORE DI PRESSIONE CON DISTRIBUTOR</td> <td>1</td> <td>PZ</td> </tr> <tr> <td>VL1014B0</td> <td>RIDUTTORE DI PRESSIONE CON DISTRIBUTOR</td> <td>1</td> <td>PZ</td> </tr> <tr> <td>VL1034C0</td> <td>FILTRO ACQUA D10 MESH100</td> <td>1</td> <td>PZ</td> </tr> <tr> <td>VL1062C0</td> <td>FORCELLA BLOCCA FILTRO-RIDUT TORE PRES.</td> <td>1</td> <td>PZ</td> </tr> <tr> <td>VM1053A0</td> <td>TAPPO 1/8" CIL CON O-RIN</td> <td>2</td> <td>PZ</td> </tr> <tr> <td>VM1054A0</td> <td>GHIERA RIDUTTORE DI PRESSIONE H7.8</td> <td>1</td> <td>PZ</td> </tr> </tbody> </table>	Codice	Descrizione	Qtà	UM	0H7472A1	LAMIERA SUPPORTO DISTRIBUTOR	1	PZ	RC1004A0	RACCORDO Y Ø10-Ø8-8	1	PZ	RC1243A0	RACCORDO GOMITO CODOLO Ø10F-Ø10M	1	PZ	RC1372A0	RACCORDO DRITTO Ø10M-1/4 M.CI	2	PZ	VI1013A1	RONDELLA PIANA 30.5X39.5X3 NYLON	1	PZ	VI1220A1	VITE AUTOFILETTA NTE 4.2X11 TCS+ MARUTE	2	PZ	VL1014A0	RIDUTTORE DI PRESSIONE CON DISTRIBUTOR	1	PZ	VL1014B0	RIDUTTORE DI PRESSIONE CON DISTRIBUTOR	1	PZ	VL1034C0	FILTRO ACQUA D10 MESH100	1	PZ	VL1062C0	FORCELLA BLOCCA FILTRO-RIDUT TORE PRES.	1	PZ	VM1053A0	TAPPO 1/8" CIL CON O-RIN	2	PZ	VM1054A0	GHIERA RIDUTTORE DI PRESSIONE H7.8	1	PZ
Codice	Descrizione	Qtà	UM																																																						
0H7472A1	LAMIERA SUPPORTO DISTRIBUTOR	1	PZ																																																						
RC1004A0	RACCORDO Y Ø10-Ø8-8	1	PZ																																																						
RC1243A0	RACCORDO GOMITO CODOLO Ø10F-Ø10M	1	PZ																																																						
RC1372A0	RACCORDO DRITTO Ø10M-1/4 M.CI	2	PZ																																																						
VI1013A1	RONDELLA PIANA 30.5X39.5X3 NYLON	1	PZ																																																						
VI1220A1	VITE AUTOFILETTA NTE 4.2X11 TCS+ MARUTE	2	PZ																																																						
VL1014A0	RIDUTTORE DI PRESSIONE CON DISTRIBUTOR	1	PZ																																																						
VL1014B0	RIDUTTORE DI PRESSIONE CON DISTRIBUTOR	1	PZ																																																						
VL1034C0	FILTRO ACQUA D10 MESH100	1	PZ																																																						
VL1062C0	FORCELLA BLOCCA FILTRO-RIDUT TORE PRES.	1	PZ																																																						
VM1053A0	TAPPO 1/8" CIL CON O-RIN	2	PZ																																																						
VM1054A0	GHIERA RIDUTTORE DI PRESSIONE H7.8	1	PZ																																																						

COMPONENTE			RICAMBIO																																																						
Codice	Descrizione	Immagine	Codice	Descrizione	Lista componenti																																																				
RC1372A	RACCORDO DRITTO Ø10M-1/4 M CIL		KRC1372A	KIT RACCORDO DRITTO D 10M-1/4 M CIL	<table border="1"> <thead> <tr> <th>Codice</th> <th>Descrizione</th> <th>Qtà</th> <th>UM</th> </tr> </thead> <tbody> <tr> <td>RC1372A0</td> <td>RACCORDO DRITTO Ø10M-1/4 M CI</td> <td>1</td> <td>PZ</td> </tr> </tbody> </table>	Codice	Descrizione	Qtà	UM	RC1372A0	RACCORDO DRITTO Ø10M-1/4 M CI	1	PZ																																												
Codice	Descrizione	Qtà	UM																																																						
RC1372A0	RACCORDO DRITTO Ø10M-1/4 M CI	1	PZ																																																						
VL1014B	RIDUTTORE DI PRESSIONE CON DISTRIBUTORE		KVL1117A	KIT FILTRO+RID. PRESS. EUR MM 2016+LMTOP	<table border="1"> <thead> <tr> <th>Codice</th> <th>Descrizione</th> <th>Qtà</th> <th>UM</th> </tr> </thead> <tbody> <tr> <td>0H7472A1</td> <td>LAMIERA SUPPORTO DISTRIBUTOR</td> <td>1</td> <td>PZ</td> </tr> <tr> <td>RC1004A0</td> <td>RACCORDO Y Ø10-Ø8-8</td> <td>1</td> <td>PZ</td> </tr> <tr> <td>RC1243A0</td> <td>RACCORDO GOMITO CODOLO Ø10F-Ø10M</td> <td>1</td> <td>PZ</td> </tr> <tr> <td>RC1372A0</td> <td>RACCORDO DRITTO Ø10M-1/4 M CI</td> <td>2</td> <td>PZ</td> </tr> <tr> <td>VI1013A1</td> <td>RONDELLA PIANA 30.5X39.5X3 NYLON</td> <td>1</td> <td>PZ</td> </tr> <tr> <td>VI1220A1</td> <td>VITE AUTOFILETTA NTE 4.2X11 TCS+ MARUTE</td> <td>2</td> <td>PZ</td> </tr> <tr> <td>VL1014A0</td> <td>RIDUTTORE DI PRESSIONE CON DISTRIBUTOR</td> <td>1</td> <td>PZ</td> </tr> <tr> <td>VL1014B0</td> <td>RIDUTTORE DI PRESSIONE CON DISTRIBUTOR</td> <td>1</td> <td>PZ</td> </tr> <tr> <td>VL1034C0</td> <td>FILTRO ACQUA D10 MESH100</td> <td>1</td> <td>PZ</td> </tr> <tr> <td>VL1062C0</td> <td>FORCELLA BLOCCA FILTRO-RIDUT TORE PRES.</td> <td>1</td> <td>PZ</td> </tr> <tr> <td>VM1053A0</td> <td>TAPPO 1/8" CIL CON O-RIN</td> <td>2</td> <td>PZ</td> </tr> <tr> <td>VM1054A0</td> <td>GHIERA RIDUTTORE DI PRESSIONE H7.8</td> <td>1</td> <td>PZ</td> </tr> </tbody> </table>	Codice	Descrizione	Qtà	UM	0H7472A1	LAMIERA SUPPORTO DISTRIBUTOR	1	PZ	RC1004A0	RACCORDO Y Ø10-Ø8-8	1	PZ	RC1243A0	RACCORDO GOMITO CODOLO Ø10F-Ø10M	1	PZ	RC1372A0	RACCORDO DRITTO Ø10M-1/4 M CI	2	PZ	VI1013A1	RONDELLA PIANA 30.5X39.5X3 NYLON	1	PZ	VI1220A1	VITE AUTOFILETTA NTE 4.2X11 TCS+ MARUTE	2	PZ	VL1014A0	RIDUTTORE DI PRESSIONE CON DISTRIBUTOR	1	PZ	VL1014B0	RIDUTTORE DI PRESSIONE CON DISTRIBUTOR	1	PZ	VL1034C0	FILTRO ACQUA D10 MESH100	1	PZ	VL1062C0	FORCELLA BLOCCA FILTRO-RIDUT TORE PRES.	1	PZ	VM1053A0	TAPPO 1/8" CIL CON O-RIN	2	PZ	VM1054A0	GHIERA RIDUTTORE DI PRESSIONE H7.8	1	PZ
Codice	Descrizione	Qtà	UM																																																						
0H7472A1	LAMIERA SUPPORTO DISTRIBUTOR	1	PZ																																																						
RC1004A0	RACCORDO Y Ø10-Ø8-8	1	PZ																																																						
RC1243A0	RACCORDO GOMITO CODOLO Ø10F-Ø10M	1	PZ																																																						
RC1372A0	RACCORDO DRITTO Ø10M-1/4 M CI	2	PZ																																																						
VI1013A1	RONDELLA PIANA 30.5X39.5X3 NYLON	1	PZ																																																						
VI1220A1	VITE AUTOFILETTA NTE 4.2X11 TCS+ MARUTE	2	PZ																																																						
VL1014A0	RIDUTTORE DI PRESSIONE CON DISTRIBUTOR	1	PZ																																																						
VL1014B0	RIDUTTORE DI PRESSIONE CON DISTRIBUTOR	1	PZ																																																						
VL1034C0	FILTRO ACQUA D10 MESH100	1	PZ																																																						
VL1062C0	FORCELLA BLOCCA FILTRO-RIDUT TORE PRES.	1	PZ																																																						
VM1053A0	TAPPO 1/8" CIL CON O-RIN	2	PZ																																																						
VM1054A0	GHIERA RIDUTTORE DI PRESSIONE H7.8	1	PZ																																																						

COMPONENTE			RICAMBIO																																										
Codice	Descrizione	Immagine	Codice	Descrizione	Lista componenti																																								
VL1014B	RIDUTTORE DI PRESSIONE CON DISTRIBUTORE		KVL1014B	KIT RIDUTTORE DI PRESSIONE EURO MM	<table border="1"> <thead> <tr> <th>Codice</th> <th>Descrizione</th> <th>Qtà</th> <th>UM</th> </tr> </thead> <tbody> <tr> <td>EL1185A0</td> <td>RACCORDO A GOMITO J.GUEST Ø8F - Ø8F</td> <td>1</td> <td>PZ</td> </tr> <tr> <td>RC1003A0</td> <td>RACCORDO 8M-1/8 BSPP</td> <td>2</td> <td>PZ</td> </tr> <tr> <td>RC1372A0</td> <td>RACCORDO DRITTO Ø10M-1/4 M.CI</td> <td>1</td> <td>PZ</td> </tr> <tr> <td>RC1396A0</td> <td>TERMINALE DRITTO JG D10-1/4</td> <td>1</td> <td>PZ</td> </tr> <tr> <td>VL1014B0</td> <td>RIDUTTORE DI PRESSIONE CON DISTRIBUTOR</td> <td>1</td> <td>PZ</td> </tr> <tr> <td>VL1071A0</td> <td>RIDUTTORE DI PRESSIONE CON DISTRIBUTOR</td> <td>1</td> <td>PZ</td> </tr> <tr> <td>VM1054A0</td> <td>GHIERA RIDUTTORE DI PRESSIONE H7.8</td> <td>1</td> <td>PZ</td> </tr> <tr> <td>VM2028A0</td> <td>RONDELLA GOMMA 20X10X4</td> <td>1</td> <td>PZ</td> </tr> <tr> <td>VM2059A0</td> <td>TAPPO 1/4" CIL CON O-RING*</td> <td>1</td> <td>PZ</td> </tr> </tbody> </table>	Codice	Descrizione	Qtà	UM	EL1185A0	RACCORDO A GOMITO J.GUEST Ø8F - Ø8F	1	PZ	RC1003A0	RACCORDO 8M-1/8 BSPP	2	PZ	RC1372A0	RACCORDO DRITTO Ø10M-1/4 M.CI	1	PZ	RC1396A0	TERMINALE DRITTO JG D10-1/4	1	PZ	VL1014B0	RIDUTTORE DI PRESSIONE CON DISTRIBUTOR	1	PZ	VL1071A0	RIDUTTORE DI PRESSIONE CON DISTRIBUTOR	1	PZ	VM1054A0	GHIERA RIDUTTORE DI PRESSIONE H7.8	1	PZ	VM2028A0	RONDELLA GOMMA 20X10X4	1	PZ	VM2059A0	TAPPO 1/4" CIL CON O-RING*	1	PZ
			Codice	Descrizione	Qtà	UM																																							
			EL1185A0	RACCORDO A GOMITO J.GUEST Ø8F - Ø8F	1	PZ																																							
RC1003A0	RACCORDO 8M-1/8 BSPP	2	PZ																																										
RC1372A0	RACCORDO DRITTO Ø10M-1/4 M.CI	1	PZ																																										
RC1396A0	TERMINALE DRITTO JG D10-1/4	1	PZ																																										
VL1014B0	RIDUTTORE DI PRESSIONE CON DISTRIBUTOR	1	PZ																																										
VL1071A0	RIDUTTORE DI PRESSIONE CON DISTRIBUTOR	1	PZ																																										
VM1054A0	GHIERA RIDUTTORE DI PRESSIONE H7.8	1	PZ																																										
VM2028A0	RONDELLA GOMMA 20X10X4	1	PZ																																										
VM2059A0	TAPPO 1/4" CIL CON O-RING*	1	PZ																																										
KVL0014B	KIT RIDUTTORE PRESSIONE MM EUR V2 2017	<table border="1"> <thead> <tr> <th>Codice</th> <th>Descrizione</th> <th>Qtà</th> <th>UM</th> </tr> </thead> <tbody> <tr> <td>RC1372A0</td> <td>RACCORDO DRITTO Ø10M-1/4 M.CI</td> <td>1</td> <td>PZ</td> </tr> <tr> <td>RC1396A0</td> <td>TERMINALE DRITTO JG D10-1/4</td> <td>1</td> <td>PZ</td> </tr> <tr> <td>VL1014B0</td> <td>RIDUTTORE DI PRESSIONE CON DISTRIBUTOR</td> <td>1</td> <td>PZ</td> </tr> <tr> <td>VM1054A0</td> <td>GHIERA RIDUTTORE DI PRESSIONE H7.8</td> <td>1</td> <td>PZ</td> </tr> </tbody> </table>	Codice	Descrizione	Qtà	UM	RC1372A0	RACCORDO DRITTO Ø10M-1/4 M.CI	1	PZ	RC1396A0	TERMINALE DRITTO JG D10-1/4	1	PZ	VL1014B0	RIDUTTORE DI PRESSIONE CON DISTRIBUTOR	1	PZ	VM1054A0	GHIERA RIDUTTORE DI PRESSIONE H7.8	1	PZ																							
Codice	Descrizione	Qtà	UM																																										
RC1372A0	RACCORDO DRITTO Ø10M-1/4 M.CI	1	PZ																																										
RC1396A0	TERMINALE DRITTO JG D10-1/4	1	PZ																																										
VL1014B0	RIDUTTORE DI PRESSIONE CON DISTRIBUTOR	1	PZ																																										
VM1054A0	GHIERA RIDUTTORE DI PRESSIONE H7.8	1	PZ																																										
KVL0014A	KIT RIDUTTORE DI PRESSIONE MIND.MAPS EUR	<table border="1"> <thead> <tr> <th>Codice</th> <th>Descrizione</th> <th>Qtà</th> <th>UM</th> </tr> </thead> <tbody> <tr> <td>RC1372A0</td> <td>RACCORDO DRITTO Ø10M-1/4 M.CI</td> <td>2</td> <td>PZ</td> </tr> <tr> <td>VL1014A0</td> <td>RIDUTTORE DI PRESSIONE CON DISTRIBUTOR</td> <td>1</td> <td>PZ</td> </tr> </tbody> </table>	Codice	Descrizione	Qtà	UM	RC1372A0	RACCORDO DRITTO Ø10M-1/4 M.CI	2	PZ	VL1014A0	RIDUTTORE DI PRESSIONE CON DISTRIBUTOR	1	PZ																															
Codice	Descrizione	Qtà	UM																																										
RC1372A0	RACCORDO DRITTO Ø10M-1/4 M.CI	2	PZ																																										
VL1014A0	RIDUTTORE DI PRESSIONE CON DISTRIBUTOR	1	PZ																																										



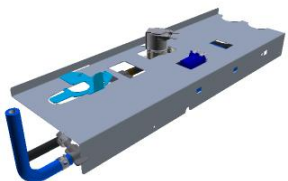

COMPONENTE			RICAMBIO																						
Codice	Descrizione	Immagine	Codice	Descrizione	Lista componenti																				
VL1014B	RIDUTTORE DI PRESSIONE CON DISTRIBUTORE		KVL0014A	KIT RIDUTTORE DI PRESSIONE MIND.MAPS EUR	<table border="1"> <thead> <tr> <th>Codice</th> <th>Descrizione</th> <th>Qtà</th> <th>UM</th> </tr> </thead> <tbody> <tr> <td>VL1014B0</td> <td>RIDUTTORE DI PRESSIONE CON DISTRIBUTOR</td> <td>1</td> <td>PZ</td> </tr> <tr> <td>VM1053A0</td> <td>TAPPO 1/8" CIL CON O-RIN</td> <td>2</td> <td>PZ</td> </tr> <tr> <td>VM1054A0</td> <td>GHIERA RIDUTTORE DI PRESSIONE H7.8</td> <td>1</td> <td>PZ</td> </tr> </tbody> </table>	Codice	Descrizione	Qtà	UM	VL1014B0	RIDUTTORE DI PRESSIONE CON DISTRIBUTOR	1	PZ	VM1053A0	TAPPO 1/8" CIL CON O-RIN	2	PZ	VM1054A0	GHIERA RIDUTTORE DI PRESSIONE H7.8	1	PZ				
			Codice		Descrizione	Qtà	UM																		
VL1014B0	RIDUTTORE DI PRESSIONE CON DISTRIBUTOR	1	PZ																						
VM1053A0	TAPPO 1/8" CIL CON O-RIN	2	PZ																						
VM1054A0	GHIERA RIDUTTORE DI PRESSIONE H7.8	1	PZ																						
KVL0010A	KIT RIDUTTORE DI PRESSIONE SERIE 4 E 5	<table border="1"> <thead> <tr> <th>Codice</th> <th>Descrizione</th> <th>Qtà</th> <th>UM</th> </tr> </thead> <tbody> <tr> <td>EL1210A0</td> <td>RACCORDO J.GUEST TERMINALE DIRITTO</td> <td>2</td> <td>PZ</td> </tr> <tr> <td>VL1014A0</td> <td>RIDUTTORE DI PRESSIONE CON DISTRIBUTOR</td> <td>1</td> <td>PZ</td> </tr> <tr> <td>VL1014B0</td> <td>RIDUTTORE DI PRESSIONE CON DISTRIBUTOR</td> <td>1</td> <td>PZ</td> </tr> <tr> <td>VM1053A0</td> <td>TAPPO 1/8" CIL CON O-RIN</td> <td>2</td> <td>PZ</td> </tr> </tbody> </table>	Codice	Descrizione	Qtà	UM	EL1210A0	RACCORDO J.GUEST TERMINALE DIRITTO	2	PZ	VL1014A0	RIDUTTORE DI PRESSIONE CON DISTRIBUTOR	1	PZ	VL1014B0	RIDUTTORE DI PRESSIONE CON DISTRIBUTOR	1	PZ	VM1053A0	TAPPO 1/8" CIL CON O-RIN	2	PZ			
Codice	Descrizione	Qtà	UM																						
EL1210A0	RACCORDO J.GUEST TERMINALE DIRITTO	2	PZ																						
VL1014A0	RIDUTTORE DI PRESSIONE CON DISTRIBUTOR	1	PZ																						
VL1014B0	RIDUTTORE DI PRESSIONE CON DISTRIBUTOR	1	PZ																						
VM1053A0	TAPPO 1/8" CIL CON O-RIN	2	PZ																						
RC1396A	TERMINALE DRITTO JG D10-1/4		KVL0014B	KIT RIDUTTORE PRESSIONE MM EUR V2 2017	<table border="1"> <thead> <tr> <th>Codice</th> <th>Descrizione</th> <th>Qtà</th> <th>UM</th> </tr> </thead> <tbody> <tr> <td>RC1372A0</td> <td>RACCORDO DRITTO Ø10M-1/4 M CI</td> <td>1</td> <td>PZ</td> </tr> <tr> <td>RC1396A0</td> <td>TERMINALE DRITTO JG D10-1/4</td> <td>1</td> <td>PZ</td> </tr> <tr> <td>VL1014B0</td> <td>RIDUTTORE DI PRESSIONE CON DISTRIBUTOR</td> <td>1</td> <td>PZ</td> </tr> <tr> <td>VM1054A0</td> <td>GHIERA RIDUTTORE DI PRESSIONE H7.8</td> <td>1</td> <td>PZ</td> </tr> </tbody> </table>	Codice	Descrizione	Qtà	UM	RC1372A0	RACCORDO DRITTO Ø10M-1/4 M CI	1	PZ	RC1396A0	TERMINALE DRITTO JG D10-1/4	1	PZ	VL1014B0	RIDUTTORE DI PRESSIONE CON DISTRIBUTOR	1	PZ	VM1054A0	GHIERA RIDUTTORE DI PRESSIONE H7.8	1	PZ
			Codice		Descrizione	Qtà	UM																		
RC1372A0	RACCORDO DRITTO Ø10M-1/4 M CI	1	PZ																						
RC1396A0	TERMINALE DRITTO JG D10-1/4	1	PZ																						
VL1014B0	RIDUTTORE DI PRESSIONE CON DISTRIBUTOR	1	PZ																						
VM1054A0	GHIERA RIDUTTORE DI PRESSIONE H7.8	1	PZ																						
VL1063A	PORTAGOMMA D8 CODOLO D10		KVL1125A	KIT 10PZ RAC CURVO M-M PORTAG D8-COD D1	<table border="1"> <thead> <tr> <th>Codice</th> <th>Descrizione</th> <th>Qtà</th> <th>UM</th> </tr> </thead> <tbody> <tr> <td>VL1125A0</td> <td>RACCORDO CURVO M-M PORTAGOMMA A D8- CODOLO</td> <td>10</td> <td>PZ</td> </tr> </tbody> </table>	Codice	Descrizione	Qtà	UM	VL1125A0	RACCORDO CURVO M-M PORTAGOMMA A D8- CODOLO	10	PZ												
Codice	Descrizione	Qtà	UM																						
VL1125A0	RACCORDO CURVO M-M PORTAGOMMA A D8- CODOLO	10	PZ																						
			KVL1063A	KIT 10PZ PORTAGOMMA D8 CODOLO D10	<table border="1"> <thead> <tr> <th>Codice</th> <th>Descrizione</th> <th>Qtà</th> <th>UM</th> </tr> </thead> <tbody> <tr> <td>VL1063A0</td> <td>PORTAGOMMA A D8 CODOLO D10</td> <td>10</td> <td>PZ</td> </tr> </tbody> </table>	Codice	Descrizione	Qtà	UM	VL1063A0	PORTAGOMMA A D8 CODOLO D10	10	PZ												
Codice	Descrizione	Qtà	UM																						
VL1063A0	PORTAGOMMA A D8 CODOLO D10	10	PZ																						

COMPONENTE			RICAMBIO																						
Codice	Descrizione	Immagine	Codice	Descrizione	Lista componenti																				
RC1046A	FASCETTA STRINGI TUBO D10-16 H9 INO		KRC1046A	KIT 10PZ FASCETTA STRINGI TUBO D10-16 H9	<table border="1"> <thead> <tr> <th>Codice</th> <th>Descrizione</th> <th>Qtà</th> <th>UM</th> </tr> </thead> <tbody> <tr> <td>RC1046A0</td> <td>FASCETTA STRINGI TUBO D10-16 H9 INO</td> <td>10</td> <td>PZ</td> </tr> </tbody> </table>	Codice	Descrizione	Qtà	UM	RC1046A0	FASCETTA STRINGI TUBO D10-16 H9 INO	10	PZ												
Codice	Descrizione	Qtà	UM																						
RC1046A0	FASCETTA STRINGI TUBO D10-16 H9 INO	10	PZ																						
VL1096A	RACCORDO A T -2X PORTAGOMMA D6 - D10 E		KVL1096A	KIT 2PZ RACCORDO T-PORTAG D6-D10-MAGNETI	<table border="1"> <thead> <tr> <th>Codice</th> <th>Descrizione</th> <th>Qtà</th> <th>UM</th> </tr> </thead> <tbody> <tr> <td>RC1018A0</td> <td>FASCETTA ELASTICA D12 ZINCATA</td> <td>2</td> <td>PZ</td> </tr> <tr> <td>VL1086A0</td> <td>MAGNETE NEODIMIO ANTICALCARE</td> <td>2</td> <td>PZ</td> </tr> <tr> <td>VL1096A0</td> <td>RACCORDO A T -2X PORTAGOMMA A D6 - D10 E</td> <td>1</td> <td>PZ</td> </tr> </tbody> </table>	Codice	Descrizione	Qtà	UM	RC1018A0	FASCETTA ELASTICA D12 ZINCATA	2	PZ	VL1086A0	MAGNETE NEODIMIO ANTICALCARE	2	PZ	VL1096A0	RACCORDO A T -2X PORTAGOMMA A D6 - D10 E	1	PZ				
Codice	Descrizione	Qtà	UM																						
RC1018A0	FASCETTA ELASTICA D12 ZINCATA	2	PZ																						
VL1086A0	MAGNETE NEODIMIO ANTICALCARE	2	PZ																						
VL1096A0	RACCORDO A T -2X PORTAGOMMA A D6 - D10 E	1	PZ																						
0F1507B	SCHIENA INFERIORE XEVC-2011																								
VL1047A	PORTAGOMMA D6 CODOLO D8		KVL1047A KVL0016A	KIT 10 PZ PORTAGOMMA D6 CODOLO D8 KIT 260PZ ADATTAMENTO BRITA IMP.LAVAG M	<table border="1"> <thead> <tr> <th>Codice</th> <th>Descrizione</th> <th>Qtà</th> <th>UM</th> </tr> </thead> <tbody> <tr> <td>VL1047A1</td> <td>PORTAGOMMA A D6 CODOLO D8</td> <td>10</td> <td>PZ</td> </tr> <tr> <td>EL1185A0</td> <td>RACCORDO A GOMITO J.GUEST Ø8F - Ø8F</td> <td>1</td> <td>PZ</td> </tr> <tr> <td>RC1018A0</td> <td>FASCETTA ELASTICA D12 ZINCATA</td> <td>2</td> <td>PZ</td> </tr> <tr> <td>VL1047A1</td> <td>PORTAGOMMA A D6 CODOLO D8</td> <td>2</td> <td>PZ</td> </tr> </tbody> </table>	Codice	Descrizione	Qtà	UM	VL1047A1	PORTAGOMMA A D6 CODOLO D8	10	PZ	EL1185A0	RACCORDO A GOMITO J.GUEST Ø8F - Ø8F	1	PZ	RC1018A0	FASCETTA ELASTICA D12 ZINCATA	2	PZ	VL1047A1	PORTAGOMMA A D6 CODOLO D8	2	PZ
Codice	Descrizione	Qtà	UM																						
VL1047A1	PORTAGOMMA A D6 CODOLO D8	10	PZ																						
EL1185A0	RACCORDO A GOMITO J.GUEST Ø8F - Ø8F	1	PZ																						
RC1018A0	FASCETTA ELASTICA D12 ZINCATA	2	PZ																						
VL1047A1	PORTAGOMMA A D6 CODOLO D8	2	PZ																						

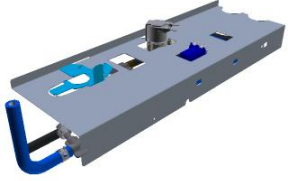
COMPONENTE			RICAMBIO																																										
Codice	Descrizione	Immagine	Codice	Descrizione	Lista componenti																																								
VL1095A	RACCORDO DRITTO M-M PORTAGOMMA D7.8- D10		KVL1095A	KIT 10PZ RACC DRITTO M-M PORTAG D7-D10	<table border="1"> <thead> <tr> <th>Codice</th> <th>Descrizione</th> <th>Qtà</th> <th>UM</th> </tr> </thead> <tbody> <tr> <td>VL1095A0</td> <td>RACCORDO DRITTO M-M PORTAGOMM A D7.8- D10</td> <td>10</td> <td>PZ</td> </tr> </tbody> </table>	Codice	Descrizione	Qtà	UM	VL1095A0	RACCORDO DRITTO M-M PORTAGOMM A D7.8- D10	10	PZ																																
Codice	Descrizione	Qtà	UM																																										
VL1095A0	RACCORDO DRITTO M-M PORTAGOMM A D7.8- D10	10	PZ																																										
0H7515A	LAMIERA DOPPIO LAVAGGIO XEVC-2011-E1R		0H7515A0	LAMIERA DOPPIO LAVAGGIO XEVC-2011-E1R																																									
VL1127A	RACCORDO A T BARBED 6		KVL1127A	KIT 10 PZ RACCORDO A T BARBED 6MM	<table border="1"> <thead> <tr> <th>Codice</th> <th>Descrizione</th> <th>Qtà</th> <th>UM</th> </tr> </thead> <tbody> <tr> <td>VL1127A0</td> <td>RACCORDO A T BARBED 6</td> <td>10</td> <td>PZ</td> </tr> </tbody> </table>	Codice	Descrizione	Qtà	UM	VL1127A0	RACCORDO A T BARBED 6	10	PZ																																
Codice	Descrizione	Qtà	UM																																										
VL1127A0	RACCORDO A T BARBED 6	10	PZ																																										
VL1106B	ASM LAVAGGIO ONE EU MONO GIRANTE		KVL1109A	KIT IMPIANTO LAVAGGIO ONE 2 GIRANTI EUR	<table border="1"> <thead> <tr> <th>Codice</th> <th>Descrizione</th> <th>Qtà</th> <th>UM</th> </tr> </thead> <tbody> <tr> <td>0H7324A0</td> <td>LAMIERA SUPPORTO LAVAGGIO ON</td> <td>2</td> <td>PZ</td> </tr> <tr> <td>0H7515A0</td> <td>LAMIERA DOPPIO LAVAGGIO XEVC-2011-E1</td> <td>1</td> <td>PZ</td> </tr> <tr> <td>CH1000A0</td> <td>TAGLIATUBI SNIP</td> <td>1</td> <td>PZ</td> </tr> <tr> <td>EL1115A0</td> <td>RACCORDO A Y Ø8 FEMMINA</td> <td>1</td> <td>PZ</td> </tr> <tr> <td>EL1436A0</td> <td>EV H2O JG D8-PORTAGO MMA D6 CHECK VALVE</td> <td>2</td> <td>PZ</td> </tr> <tr> <td>GN1526A0</td> <td>O-RING D.INT6.9 SP1.8</td> <td>2</td> <td>PZ</td> </tr> <tr> <td>RC1006A0</td> <td>CURVA GUIDA TUBO PET D8</td> <td>4</td> <td>PZ</td> </tr> <tr> <td>RC1019A0</td> <td>FASCETTA ELASTICA D10 ZINCATA</td> <td>30</td> <td>PZ</td> </tr> <tr> <td>RC1242A0</td> <td>TERMINALE CHIUSO D10</td> <td>4</td> <td>PZ</td> </tr> </tbody> </table>	Codice	Descrizione	Qtà	UM	0H7324A0	LAMIERA SUPPORTO LAVAGGIO ON	2	PZ	0H7515A0	LAMIERA DOPPIO LAVAGGIO XEVC-2011-E1	1	PZ	CH1000A0	TAGLIATUBI SNIP	1	PZ	EL1115A0	RACCORDO A Y Ø8 FEMMINA	1	PZ	EL1436A0	EV H2O JG D8-PORTAGO MMA D6 CHECK VALVE	2	PZ	GN1526A0	O-RING D.INT6.9 SP1.8	2	PZ	RC1006A0	CURVA GUIDA TUBO PET D8	4	PZ	RC1019A0	FASCETTA ELASTICA D10 ZINCATA	30	PZ	RC1242A0	TERMINALE CHIUSO D10	4	PZ
Codice	Descrizione	Qtà	UM																																										
0H7324A0	LAMIERA SUPPORTO LAVAGGIO ON	2	PZ																																										
0H7515A0	LAMIERA DOPPIO LAVAGGIO XEVC-2011-E1	1	PZ																																										
CH1000A0	TAGLIATUBI SNIP	1	PZ																																										
EL1115A0	RACCORDO A Y Ø8 FEMMINA	1	PZ																																										
EL1436A0	EV H2O JG D8-PORTAGO MMA D6 CHECK VALVE	2	PZ																																										
GN1526A0	O-RING D.INT6.9 SP1.8	2	PZ																																										
RC1006A0	CURVA GUIDA TUBO PET D8	4	PZ																																										
RC1019A0	FASCETTA ELASTICA D10 ZINCATA	30	PZ																																										
RC1242A0	TERMINALE CHIUSO D10	4	PZ																																										

COMPONENTE			RICAMBIO																																																						
Codice	Descrizione	Immagine	Codice	Descrizione	Lista componenti																																																				
VL1106B	ASM LAVAGGIO ONE EU MONO GIRANTE		KVL1109A	KIT IMPIANTO LAVAGGIO ONE 2 GIRANTI EUR	<table border="1"> <thead> <tr> <th>Codice</th> <th>Descrizione</th> <th>Qtà</th> <th>UM</th> </tr> </thead> <tbody> <tr> <td>TB1818A0</td> <td>TUBO 8X4.75 PE BLU</td> <td>1.640</td> <td>M</td> </tr> <tr> <td>TB2820A0</td> <td>TUBO EPDM 6X10</td> <td>2.760</td> <td>M</td> </tr> <tr> <td>V11220A1</td> <td>VITE AUTOFILETTA NTE 4.2X11 TCS+ MARUTE</td> <td>8</td> <td>PZ</td> </tr> <tr> <td>VL1019A0</td> <td>POMPA VIBRAZIONE</td> <td>2</td> <td>PZ</td> </tr> <tr> <td>VL1053B0</td> <td>DISTRIBUTOR E USCITA LAVAGGIO ON</td> <td>2</td> <td>PZ</td> </tr> <tr> <td>VL1054B0</td> <td>DISTRIBUTOR E INGRESSI LAVAGGIO ON</td> <td>2</td> <td>PZ</td> </tr> <tr> <td>VL1080A0</td> <td>FILTRO IN LINEA DETERGENTE</td> <td>2</td> <td>PZ</td> </tr> <tr> <td>VL1081A0</td> <td>VALVOLA NON RITORNO BARBED D6</td> <td>4</td> <td>PZ</td> </tr> <tr> <td>VL1102A0</td> <td>FILTRO IN LINEA CON VNR BARBED 6 MM</td> <td>2</td> <td>PZ</td> </tr> <tr> <td>VL1102A1</td> <td>FILTRO IN LINEA DET. + VNR BARBED 6 MM</td> <td>2</td> <td>PZ</td> </tr> <tr> <td>VL1128A0</td> <td>VALVOLA VNR BARBED D6</td> <td>2</td> <td>PZ</td> </tr> <tr> <td>VM2172A0</td> <td>CLIP BLOCCAGGIO POMPA CON CIRCUITO</td> <td>2</td> <td>PZ</td> </tr> </tbody> </table>	Codice	Descrizione	Qtà	UM	TB1818A0	TUBO 8X4.75 PE BLU	1.640	M	TB2820A0	TUBO EPDM 6X10	2.760	M	V11220A1	VITE AUTOFILETTA NTE 4.2X11 TCS+ MARUTE	8	PZ	VL1019A0	POMPA VIBRAZIONE	2	PZ	VL1053B0	DISTRIBUTOR E USCITA LAVAGGIO ON	2	PZ	VL1054B0	DISTRIBUTOR E INGRESSI LAVAGGIO ON	2	PZ	VL1080A0	FILTRO IN LINEA DETERGENTE	2	PZ	VL1081A0	VALVOLA NON RITORNO BARBED D6	4	PZ	VL1102A0	FILTRO IN LINEA CON VNR BARBED 6 MM	2	PZ	VL1102A1	FILTRO IN LINEA DET. + VNR BARBED 6 MM	2	PZ	VL1128A0	VALVOLA VNR BARBED D6	2	PZ	VM2172A0	CLIP BLOCCAGGIO POMPA CON CIRCUITO	2	PZ
			Codice	Descrizione	Qtà	UM																																																			
TB1818A0	TUBO 8X4.75 PE BLU	1.640	M																																																						
TB2820A0	TUBO EPDM 6X10	2.760	M																																																						
V11220A1	VITE AUTOFILETTA NTE 4.2X11 TCS+ MARUTE	8	PZ																																																						
VL1019A0	POMPA VIBRAZIONE	2	PZ																																																						
VL1053B0	DISTRIBUTOR E USCITA LAVAGGIO ON	2	PZ																																																						
VL1054B0	DISTRIBUTOR E INGRESSI LAVAGGIO ON	2	PZ																																																						
VL1080A0	FILTRO IN LINEA DETERGENTE	2	PZ																																																						
VL1081A0	VALVOLA NON RITORNO BARBED D6	4	PZ																																																						
VL1102A0	FILTRO IN LINEA CON VNR BARBED 6 MM	2	PZ																																																						
VL1102A1	FILTRO IN LINEA DET. + VNR BARBED 6 MM	2	PZ																																																						
VL1128A0	VALVOLA VNR BARBED D6	2	PZ																																																						
VM2172A0	CLIP BLOCCAGGIO POMPA CON CIRCUITO	2	PZ																																																						
KVL1106A	KIT IMPIANTO LAVAGGIO ONE 1 GIRANTE EUR	<table border="1"> <thead> <tr> <th>Codice</th> <th>Descrizione</th> <th>Qtà</th> <th>UM</th> </tr> </thead> <tbody> <tr> <td>0H7324A0</td> <td>LAMIERA SUPPORTO LAVAGGIO ON</td> <td>1</td> <td>PZ</td> </tr> <tr> <td>0H7819A0</td> <td>SUPPORTO LAVAGGIO ONE CON ELV STEAM</td> <td>1</td> <td>PZ</td> </tr> <tr> <td>EL1436A0</td> <td>EV H2O JG D8-PORTAGO MMA D6 CHECK VALVE</td> <td>1</td> <td>PZ</td> </tr> <tr> <td>GN1526A0</td> <td>O-RING D.INT6.9 SP1.8</td> <td>1</td> <td>PZ</td> </tr> <tr> <td>RC1006A0</td> <td>CURVA GUIDA TUBO PET D8</td> <td>2</td> <td>PZ</td> </tr> </tbody> </table>	Codice	Descrizione	Qtà	UM	0H7324A0	LAMIERA SUPPORTO LAVAGGIO ON	1	PZ	0H7819A0	SUPPORTO LAVAGGIO ONE CON ELV STEAM	1	PZ	EL1436A0	EV H2O JG D8-PORTAGO MMA D6 CHECK VALVE	1	PZ	GN1526A0	O-RING D.INT6.9 SP1.8	1	PZ	RC1006A0	CURVA GUIDA TUBO PET D8	2	PZ																															
Codice	Descrizione	Qtà	UM																																																						
0H7324A0	LAMIERA SUPPORTO LAVAGGIO ON	1	PZ																																																						
0H7819A0	SUPPORTO LAVAGGIO ONE CON ELV STEAM	1	PZ																																																						
EL1436A0	EV H2O JG D8-PORTAGO MMA D6 CHECK VALVE	1	PZ																																																						
GN1526A0	O-RING D.INT6.9 SP1.8	1	PZ																																																						
RC1006A0	CURVA GUIDA TUBO PET D8	2	PZ																																																						

COMPONENTE			RICAMBIO																																																																		
Codice	Descrizione	Immagine	Codice	Descrizione	Lista componenti																																																																
VL1106B	ASM LAVAGGIO ONE EU MONO GIRANTE		KVL1106A	KIT IMPIANTO LAVAGGIO ONE 1 GIRANTE EUR	<table border="1"> <thead> <tr> <th>Codice</th> <th>Descrizione</th> <th>Qtà</th> <th>UM</th> </tr> </thead> <tbody> <tr> <td>RC1019A0</td> <td>FASCETTA ELASTICA D10 ZINCATA</td> <td>15</td> <td>PZ</td> </tr> <tr> <td>RC1242A0</td> <td>TERMINALE CHIUSO D10</td> <td>2</td> <td>PZ</td> </tr> <tr> <td>RC1408A0</td> <td>FASCETTA BIFILARE A MOLLA D10.8 TUBO ZN</td> <td>2</td> <td>PZ</td> </tr> <tr> <td>TB1818A0</td> <td>TUBO 8X4.75 PE BLU</td> <td>0.320</td> <td>M</td> </tr> <tr> <td>TB2820A0</td> <td>TUBO EPDM 6X10</td> <td>1.380</td> <td>M</td> </tr> <tr> <td>VI1220A1</td> <td>VITE AUTOFILETTA NTE 4.2X11 TCS+ MARUTE</td> <td>1</td> <td>PZ</td> </tr> <tr> <td>VL1019A0</td> <td>POMPA VIBRAZIONE</td> <td>1</td> <td>PZ</td> </tr> <tr> <td>VL1053B0</td> <td>DISTRIBUTOR E USCITA LAVAGGIO ON</td> <td>1</td> <td>PZ</td> </tr> <tr> <td>VL1054B0</td> <td>DISTRIBUTOR E INGRESSI LAVAGGIO ON</td> <td>1</td> <td>PZ</td> </tr> <tr> <td>VL1080A0</td> <td>FILTRO IN LINEA DETERGENTE</td> <td>1</td> <td>PZ</td> </tr> <tr> <td>VL1081A0</td> <td>VALVOLA NON RITORNO BARBED D6</td> <td>1</td> <td>PZ</td> </tr> <tr> <td>VL1102A0</td> <td>FILTRO IN LINEA CON VNR BARBED 6 MM</td> <td>1</td> <td>PZ</td> </tr> <tr> <td>VL1102A1</td> <td>FILTRO IN LINEA DET. + VNR BARBED 6 MM</td> <td>1</td> <td>PZ</td> </tr> <tr> <td>VL1128A0</td> <td>VALVOLA VNR BARBED D6</td> <td>1</td> <td>PZ</td> </tr> <tr> <td>VM2172A0</td> <td>CLIP BLOCCAGGIO POMPA CON CIRCUITO</td> <td>1</td> <td>PZ</td> </tr> </tbody> </table>	Codice	Descrizione	Qtà	UM	RC1019A0	FASCETTA ELASTICA D10 ZINCATA	15	PZ	RC1242A0	TERMINALE CHIUSO D10	2	PZ	RC1408A0	FASCETTA BIFILARE A MOLLA D10.8 TUBO ZN	2	PZ	TB1818A0	TUBO 8X4.75 PE BLU	0.320	M	TB2820A0	TUBO EPDM 6X10	1.380	M	VI1220A1	VITE AUTOFILETTA NTE 4.2X11 TCS+ MARUTE	1	PZ	VL1019A0	POMPA VIBRAZIONE	1	PZ	VL1053B0	DISTRIBUTOR E USCITA LAVAGGIO ON	1	PZ	VL1054B0	DISTRIBUTOR E INGRESSI LAVAGGIO ON	1	PZ	VL1080A0	FILTRO IN LINEA DETERGENTE	1	PZ	VL1081A0	VALVOLA NON RITORNO BARBED D6	1	PZ	VL1102A0	FILTRO IN LINEA CON VNR BARBED 6 MM	1	PZ	VL1102A1	FILTRO IN LINEA DET. + VNR BARBED 6 MM	1	PZ	VL1128A0	VALVOLA VNR BARBED D6	1	PZ	VM2172A0	CLIP BLOCCAGGIO POMPA CON CIRCUITO	1	PZ
Codice	Descrizione	Qtà	UM																																																																		
RC1019A0	FASCETTA ELASTICA D10 ZINCATA	15	PZ																																																																		
RC1242A0	TERMINALE CHIUSO D10	2	PZ																																																																		
RC1408A0	FASCETTA BIFILARE A MOLLA D10.8 TUBO ZN	2	PZ																																																																		
TB1818A0	TUBO 8X4.75 PE BLU	0.320	M																																																																		
TB2820A0	TUBO EPDM 6X10	1.380	M																																																																		
VI1220A1	VITE AUTOFILETTA NTE 4.2X11 TCS+ MARUTE	1	PZ																																																																		
VL1019A0	POMPA VIBRAZIONE	1	PZ																																																																		
VL1053B0	DISTRIBUTOR E USCITA LAVAGGIO ON	1	PZ																																																																		
VL1054B0	DISTRIBUTOR E INGRESSI LAVAGGIO ON	1	PZ																																																																		
VL1080A0	FILTRO IN LINEA DETERGENTE	1	PZ																																																																		
VL1081A0	VALVOLA NON RITORNO BARBED D6	1	PZ																																																																		
VL1102A0	FILTRO IN LINEA CON VNR BARBED 6 MM	1	PZ																																																																		
VL1102A1	FILTRO IN LINEA DET. + VNR BARBED 6 MM	1	PZ																																																																		
VL1128A0	VALVOLA VNR BARBED D6	1	PZ																																																																		
VM2172A0	CLIP BLOCCAGGIO POMPA CON CIRCUITO	1	PZ																																																																		

COMPONENTE			RICAMBIO																										
Codice	Descrizione	Immagine	Codice	Descrizione	Lista componenti																								
RC1019A	FASCETTA ELASTICA D10 ZINCATA		KRC1019A	KIT 15 PZ. FASCETTA ELASTICA D10 ZINCATA	<table border="1"> <thead> <tr> <th>Codice</th> <th>Descrizione</th> <th>Qtà</th> <th>UM</th> </tr> </thead> <tbody> <tr> <td>RC1019A0</td> <td>FASCETTA ELASTICA D10 ZINCATA</td> <td>15</td> <td>PZ</td> </tr> </tbody> </table>	Codice	Descrizione	Qtà	UM	RC1019A0	FASCETTA ELASTICA D10 ZINCATA	15	PZ																
Codice	Descrizione	Qtà	UM																										
RC1019A0	FASCETTA ELASTICA D10 ZINCATA	15	PZ																										
TB3007A	TB2820A-ROCCETTO DETERGENTE ONE PER GIR		KTB3007A	KIT ROCCETTO DETERGENTE ONE	<table border="1"> <thead> <tr> <th>Codice</th> <th>Descrizione</th> <th>Qtà</th> <th>UM</th> </tr> </thead> <tbody> <tr> <td>TB2820A0</td> <td>TUBO EPDM 6X10</td> <td>0.550</td> <td>M</td> </tr> </tbody> </table>	Codice	Descrizione	Qtà	UM	TB2820A0	TUBO EPDM 6X10	0.550	M																
Codice	Descrizione	Qtà	UM																										
TB2820A0	TUBO EPDM 6X10	0.550	M																										
TB3225B	TB2820A-COLLEGAMENTO TANICA-GRUPPO LAVAG		TB3225B0	TB2820A-COLLEGAMENTO TANICA-GRUPPO LAVAG																									
VL1127A	RACCORDO A T BARBED 6		KVL1127A	KIT 10 PZ RACCORDO A T BARBED 6MM	<table border="1"> <thead> <tr> <th>Codice</th> <th>Descrizione</th> <th>Qtà</th> <th>UM</th> </tr> </thead> <tbody> <tr> <td>VL1127A0</td> <td>RACCORDO A T BARBED 6</td> <td>10</td> <td>PZ</td> </tr> </tbody> </table>	Codice	Descrizione	Qtà	UM	VL1127A0	RACCORDO A T BARBED 6	10	PZ																
Codice	Descrizione	Qtà	UM																										
VL1127A0	RACCORDO A T BARBED 6	10	PZ																										
VL1047A	PORTAGOMMA D6 CODOLO D8		KVL1047A KVL0016A	KIT 10 PZ PORTAGOMMA D6 CODOLO D8 KIT 260PZ ADATTAMENTO BRITA IMP.LAVAG M	<table border="1"> <thead> <tr> <th>Codice</th> <th>Descrizione</th> <th>Qtà</th> <th>UM</th> </tr> </thead> <tbody> <tr> <td>VL1047A1</td> <td>PORTAGOMMA D6 A D6 CODOLO D8</td> <td>10</td> <td>PZ</td> </tr> </tbody> </table> <table border="1"> <thead> <tr> <th>Codice</th> <th>Descrizione</th> <th>Qtà</th> <th>UM</th> </tr> </thead> <tbody> <tr> <td>EL1185A0</td> <td>RACCORDO A GOMITO J.GUEST Ø8F - Ø8F</td> <td>1</td> <td>PZ</td> </tr> <tr> <td>RC1018A0</td> <td>FASCETTA ELASTICA D12 ZINCATA</td> <td>2</td> <td>PZ</td> </tr> <tr> <td>VL1047A1</td> <td>PORTAGOMMA A D6 CODOLO D8</td> <td>2</td> <td>PZ</td> </tr> </tbody> </table>	Codice	Descrizione	Qtà	UM	VL1047A1	PORTAGOMMA D6 A D6 CODOLO D8	10	PZ	Codice	Descrizione	Qtà	UM	EL1185A0	RACCORDO A GOMITO J.GUEST Ø8F - Ø8F	1	PZ	RC1018A0	FASCETTA ELASTICA D12 ZINCATA	2	PZ	VL1047A1	PORTAGOMMA A D6 CODOLO D8	2	PZ
Codice	Descrizione	Qtà	UM																										
VL1047A1	PORTAGOMMA D6 A D6 CODOLO D8	10	PZ																										
Codice	Descrizione	Qtà	UM																										
EL1185A0	RACCORDO A GOMITO J.GUEST Ø8F - Ø8F	1	PZ																										
RC1018A0	FASCETTA ELASTICA D12 ZINCATA	2	PZ																										
VL1047A1	PORTAGOMMA A D6 CODOLO D8	2	PZ																										

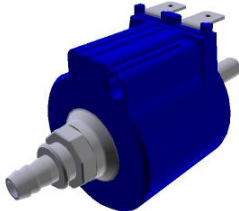
COMPONENTE			RICAMBIO																																																										
Codice	Descrizione	Immagine	Codice	Descrizione	Lista componenti																																																								
TB3254A	TB3132A-TUBO INGRESSO H2O WASHING-USA		TB3254A0	TB3132A-TUBO INGRESSO H2O WASHING-USA																																																									
VL1019A	POMPA VIBRAZIONE		KVL1120A	KIT IMPIANTO LAVAGGIO PLUS COMPACT USA	<table border="1"> <thead> <tr> <th>Codice</th> <th>Descrizione</th> <th>Qtà</th> <th>UM</th> </tr> </thead> <tbody> <tr> <td>0H7553D0</td> <td>LAMIERA CIRCUITO LAVAGGIO XECC PLUS</td> <td>1</td> <td>PZ</td> </tr> <tr> <td>EL1422A1</td> <td>ELETTROVALV 1 VIA RID.VERDE JG D8-D10 UL</td> <td>1</td> <td>PZ</td> </tr> <tr> <td>EL1426A0</td> <td>ELETTROVALV OLA UL H2O JG D8-PORTAGO MMA D</td> <td>1</td> <td>PZ</td> </tr> <tr> <td>EL1437A0</td> <td>EV H2O JG D8-PORTAGO MMA D6 CH. VALVE UL</td> <td>1</td> <td>PZ</td> </tr> <tr> <td>GN1312A0</td> <td>PASSACAVO GOMMA DE=26 DI=15 SP=10</td> <td>1</td> <td>PZ</td> </tr> <tr> <td>GN1526A0</td> <td>O-RING D.INT6.9 SP1.8</td> <td>1</td> <td>PZ</td> </tr> <tr> <td>RC1019A0</td> <td>FASCETTA ELASTICA D10 ZINCATA</td> <td>8</td> <td>PZ</td> </tr> <tr> <td>RC1242A0</td> <td>TERMINALE CHIUSO D10</td> <td>2</td> <td>PZ</td> </tr> <tr> <td>RC1356A0</td> <td>RACCORDO DRITTO FIL. FEMM 8X1/4 BSP</td> <td>1</td> <td>PZ</td> </tr> <tr> <td>RC1408A0</td> <td>FASCETTA BIFILARE A MOLLA D10.8 TUBO ZN</td> <td>2</td> <td>PZ</td> </tr> <tr> <td>TB2820A0</td> <td>TUBO EPDM 6X10</td> <td>1.200</td> <td>M</td> </tr> <tr> <td>VI1220A1</td> <td>VITE AUTOFILETTA NTE 4.2X11 TCS+ MARUTE</td> <td>9</td> <td>PZ</td> </tr> <tr> <td>VL1019A0</td> <td>POMPA VIBRAZIONE</td> <td>1</td> <td>PZ</td> </tr> </tbody> </table>	Codice	Descrizione	Qtà	UM	0H7553D0	LAMIERA CIRCUITO LAVAGGIO XECC PLUS	1	PZ	EL1422A1	ELETTROVALV 1 VIA RID.VERDE JG D8-D10 UL	1	PZ	EL1426A0	ELETTROVALV OLA UL H2O JG D8-PORTAGO MMA D	1	PZ	EL1437A0	EV H2O JG D8-PORTAGO MMA D6 CH. VALVE UL	1	PZ	GN1312A0	PASSACAVO GOMMA DE=26 DI=15 SP=10	1	PZ	GN1526A0	O-RING D.INT6.9 SP1.8	1	PZ	RC1019A0	FASCETTA ELASTICA D10 ZINCATA	8	PZ	RC1242A0	TERMINALE CHIUSO D10	2	PZ	RC1356A0	RACCORDO DRITTO FIL. FEMM 8X1/4 BSP	1	PZ	RC1408A0	FASCETTA BIFILARE A MOLLA D10.8 TUBO ZN	2	PZ	TB2820A0	TUBO EPDM 6X10	1.200	M	VI1220A1	VITE AUTOFILETTA NTE 4.2X11 TCS+ MARUTE	9	PZ	VL1019A0	POMPA VIBRAZIONE	1	PZ
Codice	Descrizione	Qtà	UM																																																										
0H7553D0	LAMIERA CIRCUITO LAVAGGIO XECC PLUS	1	PZ																																																										
EL1422A1	ELETTROVALV 1 VIA RID.VERDE JG D8-D10 UL	1	PZ																																																										
EL1426A0	ELETTROVALV OLA UL H2O JG D8-PORTAGO MMA D	1	PZ																																																										
EL1437A0	EV H2O JG D8-PORTAGO MMA D6 CH. VALVE UL	1	PZ																																																										
GN1312A0	PASSACAVO GOMMA DE=26 DI=15 SP=10	1	PZ																																																										
GN1526A0	O-RING D.INT6.9 SP1.8	1	PZ																																																										
RC1019A0	FASCETTA ELASTICA D10 ZINCATA	8	PZ																																																										
RC1242A0	TERMINALE CHIUSO D10	2	PZ																																																										
RC1356A0	RACCORDO DRITTO FIL. FEMM 8X1/4 BSP	1	PZ																																																										
RC1408A0	FASCETTA BIFILARE A MOLLA D10.8 TUBO ZN	2	PZ																																																										
TB2820A0	TUBO EPDM 6X10	1.200	M																																																										
VI1220A1	VITE AUTOFILETTA NTE 4.2X11 TCS+ MARUTE	9	PZ																																																										
VL1019A0	POMPA VIBRAZIONE	1	PZ																																																										

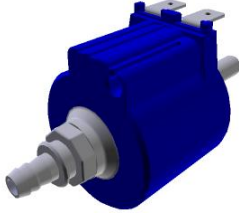
COMPONENTE			RICAMBIO																																						
Codice	Descrizione	Immagine	Codice	Descrizione	Lista componenti																																				
VL1019A	POMPA VIBRAZIONE		KVL1120A	KIT IMPIANTO LAVAGGIO PLUS COMPACT USA	<table border="1"> <thead> <tr> <th>Codice</th> <th>Descrizione</th> <th>Qtà</th> <th>UM</th> </tr> </thead> <tbody> <tr> <td>VL1054B0</td> <td>DISTRIBUTOR E INGRESSI LAVAGGIO ON</td> <td>1</td> <td>PZ</td> </tr> <tr> <td>VL1064A0</td> <td>DISTRIBUTOR E USCITE CIRCUITO LAVAGGIO PL</td> <td>1</td> <td>PZ</td> </tr> <tr> <td>VL1065A1</td> <td>PRESSOSTAT O.N.O. 1/4 M CI</td> <td>1</td> <td>PZ</td> </tr> <tr> <td>VL1081A0</td> <td>VALVOLA NON RITORNO BARBED D6</td> <td>1</td> <td>PZ</td> </tr> <tr> <td>VL1102A0</td> <td>FILTRO IN LINEA CON VNR BARBED 6 MM</td> <td>1</td> <td>PZ</td> </tr> <tr> <td>VL1102A1</td> <td>FILTRO IN LINEA DET. + VNR BARBED 6 MM</td> <td>1</td> <td>PZ</td> </tr> <tr> <td>VL1128A0</td> <td>VALVOLA VNR BARBED D6</td> <td>1</td> <td>PZ</td> </tr> <tr> <td>VM2172A0</td> <td>CLIP BLOCCAGGIO POMPA CON CIRCUITO</td> <td>1</td> <td>PZ</td> </tr> </tbody> </table>	Codice	Descrizione	Qtà	UM	VL1054B0	DISTRIBUTOR E INGRESSI LAVAGGIO ON	1	PZ	VL1064A0	DISTRIBUTOR E USCITE CIRCUITO LAVAGGIO PL	1	PZ	VL1065A1	PRESSOSTAT O.N.O. 1/4 M CI	1	PZ	VL1081A0	VALVOLA NON RITORNO BARBED D6	1	PZ	VL1102A0	FILTRO IN LINEA CON VNR BARBED 6 MM	1	PZ	VL1102A1	FILTRO IN LINEA DET. + VNR BARBED 6 MM	1	PZ	VL1128A0	VALVOLA VNR BARBED D6	1	PZ	VM2172A0	CLIP BLOCCAGGIO POMPA CON CIRCUITO	1	PZ
Codice	Descrizione	Qtà	UM																																						
VL1054B0	DISTRIBUTOR E INGRESSI LAVAGGIO ON	1	PZ																																						
VL1064A0	DISTRIBUTOR E USCITE CIRCUITO LAVAGGIO PL	1	PZ																																						
VL1065A1	PRESSOSTAT O.N.O. 1/4 M CI	1	PZ																																						
VL1081A0	VALVOLA NON RITORNO BARBED D6	1	PZ																																						
VL1102A0	FILTRO IN LINEA CON VNR BARBED 6 MM	1	PZ																																						
VL1102A1	FILTRO IN LINEA DET. + VNR BARBED 6 MM	1	PZ																																						
VL1128A0	VALVOLA VNR BARBED D6	1	PZ																																						
VM2172A0	CLIP BLOCCAGGIO POMPA CON CIRCUITO	1	PZ																																						
			KVL1119A	KIT IMPIANTO LAVAGGIO PLUS COMPACT EUR	<table border="1"> <thead> <tr> <th>Codice</th> <th>Descrizione</th> <th>Qtà</th> <th>UM</th> </tr> </thead> <tbody> <tr> <td>0H7553C0</td> <td>LAMIERA CIRCUITO LAVAGGIO XECC PLUS</td> <td>1</td> <td>PZ</td> </tr> <tr> <td>0H7553D0</td> <td>LAMIERA CIRCUITO LAVAGGIO XECC PLUS</td> <td>1</td> <td>PZ</td> </tr> <tr> <td>EL1252A1</td> <td>ELETTROVALV OLA 1 VIA RID.VERDE JG D8-D10</td> <td>1</td> <td>PZ</td> </tr> <tr> <td>EL1424A0</td> <td>ELETTROVALV OLA H2O JG D8-PORTAGO MMA D6</td> <td>1</td> <td>PZ</td> </tr> <tr> <td>EL1436A0</td> <td>EV H2O JG D8-PORTAGO MMA D6 CHECK VALVE</td> <td>1</td> <td>PZ</td> </tr> <tr> <td>GN1312A0</td> <td>PASSACAVO GOMMA DE=26 DI=15 SP=10</td> <td>1</td> <td>PZ</td> </tr> <tr> <td>GN1526A0</td> <td>O-RING D.INT6.9 SP1.8</td> <td>1</td> <td>PZ</td> </tr> </tbody> </table>	Codice	Descrizione	Qtà	UM	0H7553C0	LAMIERA CIRCUITO LAVAGGIO XECC PLUS	1	PZ	0H7553D0	LAMIERA CIRCUITO LAVAGGIO XECC PLUS	1	PZ	EL1252A1	ELETTROVALV OLA 1 VIA RID.VERDE JG D8-D10	1	PZ	EL1424A0	ELETTROVALV OLA H2O JG D8-PORTAGO MMA D6	1	PZ	EL1436A0	EV H2O JG D8-PORTAGO MMA D6 CHECK VALVE	1	PZ	GN1312A0	PASSACAVO GOMMA DE=26 DI=15 SP=10	1	PZ	GN1526A0	O-RING D.INT6.9 SP1.8	1	PZ				
Codice	Descrizione	Qtà	UM																																						
0H7553C0	LAMIERA CIRCUITO LAVAGGIO XECC PLUS	1	PZ																																						
0H7553D0	LAMIERA CIRCUITO LAVAGGIO XECC PLUS	1	PZ																																						
EL1252A1	ELETTROVALV OLA 1 VIA RID.VERDE JG D8-D10	1	PZ																																						
EL1424A0	ELETTROVALV OLA H2O JG D8-PORTAGO MMA D6	1	PZ																																						
EL1436A0	EV H2O JG D8-PORTAGO MMA D6 CHECK VALVE	1	PZ																																						
GN1312A0	PASSACAVO GOMMA DE=26 DI=15 SP=10	1	PZ																																						
GN1526A0	O-RING D.INT6.9 SP1.8	1	PZ																																						

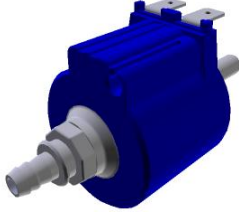
COMPONENTE			RICAMBIO																																																																																		
Codice	Descrizione	Immagine	Codice	Descrizione	Lista componenti																																																																																
VL1019A	POMPA VIBRAZIONE		KVL1119A	KIT IMPIANTO LAVAGGIO PLUS COMPACT EUR	<table border="1"> <thead> <tr> <th>Codice</th> <th>Descrizione</th> <th>Qtà</th> <th>UM</th> </tr> </thead> <tbody> <tr> <td>RC1006A0</td> <td>CURVA GUIDA TUBO PET D8</td> <td>2</td> <td>PZ</td> </tr> <tr> <td>RC1019A0</td> <td>FASCETTA ELASTICA D10 ZINCATA</td> <td>9</td> <td>PZ</td> </tr> <tr> <td>RC1242A0</td> <td>TERMINALE CHIUSO D10</td> <td>2</td> <td>PZ</td> </tr> <tr> <td>RC1356A0</td> <td>RACCORDO DRITTO FIL. FEMM 8X1/4 BSP</td> <td>1</td> <td>PZ</td> </tr> <tr> <td>RC1408A0</td> <td>FASCETTA BIFILARE A MOLLA D10.8 TUBO ZN</td> <td>2</td> <td>PZ</td> </tr> <tr> <td>TB1818A0</td> <td>TUBO 8X4.75 PE BLU</td> <td>0.680</td> <td>M</td> </tr> <tr> <td>TB2820A0</td> <td>TUBO EPDM 6X10</td> <td>1.700</td> <td>M</td> </tr> <tr> <td>VI1220A1</td> <td>VITE AUTOFILETTA NTE 4.2X11 TCS+ MARUTE</td> <td>10</td> <td>PZ</td> </tr> <tr> <td>VL1019A0</td> <td>POMPA VIBRAZIONE</td> <td>1</td> <td>PZ</td> </tr> <tr> <td>VL1054B0</td> <td>DISTRIBUTOR E INGRESSI LAVAGGIO ON</td> <td>1</td> <td>PZ</td> </tr> <tr> <td>VL1064A0</td> <td>DISTRIBUTOR E USCITE CIRCUITO LAVAGGIO PL</td> <td>1</td> <td>PZ</td> </tr> <tr> <td>VL1065A1</td> <td>PRESSOSTAT O.N.O. 1/4 M CI</td> <td>1</td> <td>PZ</td> </tr> <tr> <td>VL1081A0</td> <td>VALVOLA NON RITORNO BARBED D6</td> <td>1</td> <td>PZ</td> </tr> <tr> <td>VL1083A0</td> <td>RACCORDO D10 - PORTAGOMM A BARBED D6</td> <td>1</td> <td>PZ</td> </tr> <tr> <td>VL1102A0</td> <td>FILTRO IN LINEA CON VNR BARBED 6 MM</td> <td>1</td> <td>PZ</td> </tr> <tr> <td>VL1102A1</td> <td>FILTRO IN LINEA DET. + VNR BARBED 6 MM</td> <td>1</td> <td>PZ</td> </tr> <tr> <td>VL1128A0</td> <td>VALVOLA VNR BARBED D6</td> <td>1</td> <td>PZ</td> </tr> <tr> <td>VM1610A0</td> <td>CLIP TWIST LOCK DIAM. 7,6-10,2 MM</td> <td>3</td> <td>PZ</td> </tr> <tr> <td>VM2172A0</td> <td>CLIP BLOCCAGGIO POMPA CON CIRCUITO</td> <td>1</td> <td>PZ</td> </tr> </tbody> </table>	Codice	Descrizione	Qtà	UM	RC1006A0	CURVA GUIDA TUBO PET D8	2	PZ	RC1019A0	FASCETTA ELASTICA D10 ZINCATA	9	PZ	RC1242A0	TERMINALE CHIUSO D10	2	PZ	RC1356A0	RACCORDO DRITTO FIL. FEMM 8X1/4 BSP	1	PZ	RC1408A0	FASCETTA BIFILARE A MOLLA D10.8 TUBO ZN	2	PZ	TB1818A0	TUBO 8X4.75 PE BLU	0.680	M	TB2820A0	TUBO EPDM 6X10	1.700	M	VI1220A1	VITE AUTOFILETTA NTE 4.2X11 TCS+ MARUTE	10	PZ	VL1019A0	POMPA VIBRAZIONE	1	PZ	VL1054B0	DISTRIBUTOR E INGRESSI LAVAGGIO ON	1	PZ	VL1064A0	DISTRIBUTOR E USCITE CIRCUITO LAVAGGIO PL	1	PZ	VL1065A1	PRESSOSTAT O.N.O. 1/4 M CI	1	PZ	VL1081A0	VALVOLA NON RITORNO BARBED D6	1	PZ	VL1083A0	RACCORDO D10 - PORTAGOMM A BARBED D6	1	PZ	VL1102A0	FILTRO IN LINEA CON VNR BARBED 6 MM	1	PZ	VL1102A1	FILTRO IN LINEA DET. + VNR BARBED 6 MM	1	PZ	VL1128A0	VALVOLA VNR BARBED D6	1	PZ	VM1610A0	CLIP TWIST LOCK DIAM. 7,6-10,2 MM	3	PZ	VM2172A0	CLIP BLOCCAGGIO POMPA CON CIRCUITO	1	PZ
Codice	Descrizione	Qtà	UM																																																																																		
RC1006A0	CURVA GUIDA TUBO PET D8	2	PZ																																																																																		
RC1019A0	FASCETTA ELASTICA D10 ZINCATA	9	PZ																																																																																		
RC1242A0	TERMINALE CHIUSO D10	2	PZ																																																																																		
RC1356A0	RACCORDO DRITTO FIL. FEMM 8X1/4 BSP	1	PZ																																																																																		
RC1408A0	FASCETTA BIFILARE A MOLLA D10.8 TUBO ZN	2	PZ																																																																																		
TB1818A0	TUBO 8X4.75 PE BLU	0.680	M																																																																																		
TB2820A0	TUBO EPDM 6X10	1.700	M																																																																																		
VI1220A1	VITE AUTOFILETTA NTE 4.2X11 TCS+ MARUTE	10	PZ																																																																																		
VL1019A0	POMPA VIBRAZIONE	1	PZ																																																																																		
VL1054B0	DISTRIBUTOR E INGRESSI LAVAGGIO ON	1	PZ																																																																																		
VL1064A0	DISTRIBUTOR E USCITE CIRCUITO LAVAGGIO PL	1	PZ																																																																																		
VL1065A1	PRESSOSTAT O.N.O. 1/4 M CI	1	PZ																																																																																		
VL1081A0	VALVOLA NON RITORNO BARBED D6	1	PZ																																																																																		
VL1083A0	RACCORDO D10 - PORTAGOMM A BARBED D6	1	PZ																																																																																		
VL1102A0	FILTRO IN LINEA CON VNR BARBED 6 MM	1	PZ																																																																																		
VL1102A1	FILTRO IN LINEA DET. + VNR BARBED 6 MM	1	PZ																																																																																		
VL1128A0	VALVOLA VNR BARBED D6	1	PZ																																																																																		
VM1610A0	CLIP TWIST LOCK DIAM. 7,6-10,2 MM	3	PZ																																																																																		
VM2172A0	CLIP BLOCCAGGIO POMPA CON CIRCUITO	1	PZ																																																																																		

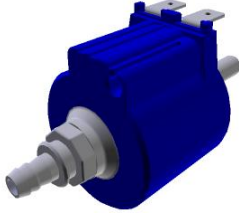
COMPONENTE			RICAMBIO																																																																						
Codice	Descrizione	Immagine	Codice	Descrizione	Lista componenti																																																																				
VL1019A	POMPA VIBRAZIONE		KVL1118A	KIT IMPIANTO LAVAGGIO ONE COMPACT EUR	<table border="1"> <thead> <tr> <th>Codice</th> <th>Descrizione</th> <th>Qtà</th> <th>UM</th> </tr> </thead> <tbody> <tr> <td>0H7173C0</td> <td>LAMIERA CIRCUITO LAVAGGIO XECC ONE</td> <td>1</td> <td>PZ</td> </tr> <tr> <td>EL1436A0</td> <td>EV H2O JG D8-PORTAGO MMA D6 CHECK VALVE</td> <td>1</td> <td>PZ</td> </tr> <tr> <td>GN1526A0</td> <td>O-RING D.INT6.9 SP1.8</td> <td>1</td> <td>PZ</td> </tr> <tr> <td>RC1019A0</td> <td>FASCETTA ELASTICA D10 ZINCATA</td> <td>10</td> <td>PZ</td> </tr> <tr> <td>RC1242A0</td> <td>TERMINALE CHIUSO D10</td> <td>2</td> <td>PZ</td> </tr> <tr> <td>RC1408A0</td> <td>FASCETTA BIFILARE A MOLLA D10.8 TUBO ZN</td> <td>2</td> <td>PZ</td> </tr> <tr> <td>TB2820A0</td> <td>TUBO EPDM 6X10</td> <td>1.200</td> <td>M</td> </tr> <tr> <td>VI1220A1</td> <td>VITE AUTOFILETTA NTE 4.2X11 TCS+ MARUTE</td> <td>6</td> <td>PZ</td> </tr> <tr> <td>VL1019A0</td> <td>POMPA VIBRAZIONE</td> <td>1</td> <td>PZ</td> </tr> <tr> <td>VL1053B0</td> <td>DISTRIBUTOR E USCITA LAVAGGIO ON</td> <td>1</td> <td>PZ</td> </tr> <tr> <td>VL1054B0</td> <td>DISTRIBUTOR E INGRESSI LAVAGGIO ON</td> <td>1</td> <td>PZ</td> </tr> <tr> <td>VL1081A0</td> <td>VALVOLA NON RITORNO BARBED D6</td> <td>1</td> <td>PZ</td> </tr> <tr> <td>VL1102A0</td> <td>FILTRO IN LINEA CON VNR BARBED 6 MM</td> <td>1</td> <td>PZ</td> </tr> <tr> <td>VL1102A1</td> <td>FILTRO IN LINEA DET. + VNR BARBED 6 MM</td> <td>1</td> <td>PZ</td> </tr> <tr> <td>VL1128A0</td> <td>VALVOLA VNR BARBED D6</td> <td>1</td> <td>PZ</td> </tr> <tr> <td>VM2172A0</td> <td>CLIP BLOCCAGGIO POMPA CON CIRCUITO</td> <td>1</td> <td>PZ</td> </tr> </tbody> </table>	Codice	Descrizione	Qtà	UM	0H7173C0	LAMIERA CIRCUITO LAVAGGIO XECC ONE	1	PZ	EL1436A0	EV H2O JG D8-PORTAGO MMA D6 CHECK VALVE	1	PZ	GN1526A0	O-RING D.INT6.9 SP1.8	1	PZ	RC1019A0	FASCETTA ELASTICA D10 ZINCATA	10	PZ	RC1242A0	TERMINALE CHIUSO D10	2	PZ	RC1408A0	FASCETTA BIFILARE A MOLLA D10.8 TUBO ZN	2	PZ	TB2820A0	TUBO EPDM 6X10	1.200	M	VI1220A1	VITE AUTOFILETTA NTE 4.2X11 TCS+ MARUTE	6	PZ	VL1019A0	POMPA VIBRAZIONE	1	PZ	VL1053B0	DISTRIBUTOR E USCITA LAVAGGIO ON	1	PZ	VL1054B0	DISTRIBUTOR E INGRESSI LAVAGGIO ON	1	PZ	VL1081A0	VALVOLA NON RITORNO BARBED D6	1	PZ	VL1102A0	FILTRO IN LINEA CON VNR BARBED 6 MM	1	PZ	VL1102A1	FILTRO IN LINEA DET. + VNR BARBED 6 MM	1	PZ	VL1128A0	VALVOLA VNR BARBED D6	1	PZ	VM2172A0	CLIP BLOCCAGGIO POMPA CON CIRCUITO	1	PZ
Codice	Descrizione	Qtà	UM																																																																						
0H7173C0	LAMIERA CIRCUITO LAVAGGIO XECC ONE	1	PZ																																																																						
EL1436A0	EV H2O JG D8-PORTAGO MMA D6 CHECK VALVE	1	PZ																																																																						
GN1526A0	O-RING D.INT6.9 SP1.8	1	PZ																																																																						
RC1019A0	FASCETTA ELASTICA D10 ZINCATA	10	PZ																																																																						
RC1242A0	TERMINALE CHIUSO D10	2	PZ																																																																						
RC1408A0	FASCETTA BIFILARE A MOLLA D10.8 TUBO ZN	2	PZ																																																																						
TB2820A0	TUBO EPDM 6X10	1.200	M																																																																						
VI1220A1	VITE AUTOFILETTA NTE 4.2X11 TCS+ MARUTE	6	PZ																																																																						
VL1019A0	POMPA VIBRAZIONE	1	PZ																																																																						
VL1053B0	DISTRIBUTOR E USCITA LAVAGGIO ON	1	PZ																																																																						
VL1054B0	DISTRIBUTOR E INGRESSI LAVAGGIO ON	1	PZ																																																																						
VL1081A0	VALVOLA NON RITORNO BARBED D6	1	PZ																																																																						
VL1102A0	FILTRO IN LINEA CON VNR BARBED 6 MM	1	PZ																																																																						
VL1102A1	FILTRO IN LINEA DET. + VNR BARBED 6 MM	1	PZ																																																																						
VL1128A0	VALVOLA VNR BARBED D6	1	PZ																																																																						
VM2172A0	CLIP BLOCCAGGIO POMPA CON CIRCUITO	1	PZ																																																																						

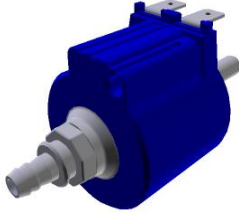
COMPONENTE			RICAMBIO																																																																																		
Codice	Descrizione	Immagine	Codice	Descrizione	Lista componenti																																																																																
VL1019A	POMPA VIBRAZIONE		KVL1109A	KIT IMPIANTO LAVAGGIO ONE 2 GIRANTI EUR	<table border="1"> <thead> <tr> <th>Codice</th> <th>Descrizione</th> <th>Qtà</th> <th>UM</th> </tr> </thead> <tbody> <tr> <td>0H7324A0</td> <td>LAMIERA SUPPORTO LAVAGGIO ON</td> <td>2</td> <td>PZ</td> </tr> <tr> <td>0H7515A0</td> <td>LAMIERA DOPPIO LAVAGGIO XEVC-2011-E1</td> <td>1</td> <td>PZ</td> </tr> <tr> <td>CH1000A0</td> <td>TAGLIATUBI SNIP</td> <td>1</td> <td>PZ</td> </tr> <tr> <td>EL1115A0</td> <td>RACCORDO A Y Ø8 FEMMINA</td> <td>1</td> <td>PZ</td> </tr> <tr> <td>EL1436A0</td> <td>EV H2O JG D8-PORTAGO MMA D6 CHECK VALVE</td> <td>2</td> <td>PZ</td> </tr> <tr> <td>GN1526A0</td> <td>O-RING D.INT6.9 SP1.8</td> <td>2</td> <td>PZ</td> </tr> <tr> <td>RC1006A0</td> <td>CURVA GUIDA TUBO PET D8</td> <td>4</td> <td>PZ</td> </tr> <tr> <td>RC1019A0</td> <td>FASCETTA ELASTICA D10 ZINCATA</td> <td>30</td> <td>PZ</td> </tr> <tr> <td>RC1242A0</td> <td>TERMINALE CHIUSO D10</td> <td>4</td> <td>PZ</td> </tr> <tr> <td>TB1818A0</td> <td>TUBO 8X4.75 PE BLU</td> <td>1.640</td> <td>M</td> </tr> <tr> <td>TB2820A0</td> <td>TUBO EPDM 6X10</td> <td>2.760</td> <td>M</td> </tr> <tr> <td>VH1220A1</td> <td>VITE AUTOFILETTA NTE 4.2X11 TCS+ MARUTE</td> <td>8</td> <td>PZ</td> </tr> <tr> <td>VL1019A0</td> <td>POMPA VIBRAZIONE</td> <td>2</td> <td>PZ</td> </tr> <tr> <td>VL1053B0</td> <td>DISTRIBUTOR E USCITA LAVAGGIO ON</td> <td>2</td> <td>PZ</td> </tr> <tr> <td>VL1054B0</td> <td>DISTRIBUTOR E INGRESSI LAVAGGIO ON</td> <td>2</td> <td>PZ</td> </tr> <tr> <td>VL1080A0</td> <td>FILTRO IN LINEA DETERGENTE</td> <td>2</td> <td>PZ</td> </tr> <tr> <td>VL1081A0</td> <td>VALVOLA NON RITORNO BARBED D6</td> <td>4</td> <td>PZ</td> </tr> <tr> <td>VL1102A0</td> <td>FILTRO IN LINEA CON VNR BARBED 6 MM</td> <td>2</td> <td>PZ</td> </tr> <tr> <td>VL1102A1</td> <td>FILTRO IN LINEA DET. + VNR BARBED 6 MM</td> <td>2</td> <td>PZ</td> </tr> </tbody> </table>	Codice	Descrizione	Qtà	UM	0H7324A0	LAMIERA SUPPORTO LAVAGGIO ON	2	PZ	0H7515A0	LAMIERA DOPPIO LAVAGGIO XEVC-2011-E1	1	PZ	CH1000A0	TAGLIATUBI SNIP	1	PZ	EL1115A0	RACCORDO A Y Ø8 FEMMINA	1	PZ	EL1436A0	EV H2O JG D8-PORTAGO MMA D6 CHECK VALVE	2	PZ	GN1526A0	O-RING D.INT6.9 SP1.8	2	PZ	RC1006A0	CURVA GUIDA TUBO PET D8	4	PZ	RC1019A0	FASCETTA ELASTICA D10 ZINCATA	30	PZ	RC1242A0	TERMINALE CHIUSO D10	4	PZ	TB1818A0	TUBO 8X4.75 PE BLU	1.640	M	TB2820A0	TUBO EPDM 6X10	2.760	M	VH1220A1	VITE AUTOFILETTA NTE 4.2X11 TCS+ MARUTE	8	PZ	VL1019A0	POMPA VIBRAZIONE	2	PZ	VL1053B0	DISTRIBUTOR E USCITA LAVAGGIO ON	2	PZ	VL1054B0	DISTRIBUTOR E INGRESSI LAVAGGIO ON	2	PZ	VL1080A0	FILTRO IN LINEA DETERGENTE	2	PZ	VL1081A0	VALVOLA NON RITORNO BARBED D6	4	PZ	VL1102A0	FILTRO IN LINEA CON VNR BARBED 6 MM	2	PZ	VL1102A1	FILTRO IN LINEA DET. + VNR BARBED 6 MM	2	PZ
Codice	Descrizione	Qtà	UM																																																																																		
0H7324A0	LAMIERA SUPPORTO LAVAGGIO ON	2	PZ																																																																																		
0H7515A0	LAMIERA DOPPIO LAVAGGIO XEVC-2011-E1	1	PZ																																																																																		
CH1000A0	TAGLIATUBI SNIP	1	PZ																																																																																		
EL1115A0	RACCORDO A Y Ø8 FEMMINA	1	PZ																																																																																		
EL1436A0	EV H2O JG D8-PORTAGO MMA D6 CHECK VALVE	2	PZ																																																																																		
GN1526A0	O-RING D.INT6.9 SP1.8	2	PZ																																																																																		
RC1006A0	CURVA GUIDA TUBO PET D8	4	PZ																																																																																		
RC1019A0	FASCETTA ELASTICA D10 ZINCATA	30	PZ																																																																																		
RC1242A0	TERMINALE CHIUSO D10	4	PZ																																																																																		
TB1818A0	TUBO 8X4.75 PE BLU	1.640	M																																																																																		
TB2820A0	TUBO EPDM 6X10	2.760	M																																																																																		
VH1220A1	VITE AUTOFILETTA NTE 4.2X11 TCS+ MARUTE	8	PZ																																																																																		
VL1019A0	POMPA VIBRAZIONE	2	PZ																																																																																		
VL1053B0	DISTRIBUTOR E USCITA LAVAGGIO ON	2	PZ																																																																																		
VL1054B0	DISTRIBUTOR E INGRESSI LAVAGGIO ON	2	PZ																																																																																		
VL1080A0	FILTRO IN LINEA DETERGENTE	2	PZ																																																																																		
VL1081A0	VALVOLA NON RITORNO BARBED D6	4	PZ																																																																																		
VL1102A0	FILTRO IN LINEA CON VNR BARBED 6 MM	2	PZ																																																																																		
VL1102A1	FILTRO IN LINEA DET. + VNR BARBED 6 MM	2	PZ																																																																																		

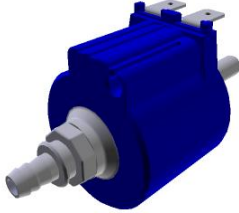
COMPONENTE			RICAMBIO																																																																						
Codice	Descrizione	Immagine	Codice	Descrizione	Lista componenti																																																																				
VL1019A	POMPA VIBRAZIONE		KVL1109A	KIT IMPIANTO LAVAGGIO ONE 2 GIRANTI EUR	<table border="1"> <thead> <tr> <th>Codice</th> <th>Descrizione</th> <th>Qtà</th> <th>UM</th> </tr> </thead> <tbody> <tr> <td>VL1128A0</td> <td>VALVOLA VNR BARBED D6</td> <td>2</td> <td>PZ</td> </tr> <tr> <td>VM2172A0</td> <td>CLIP BLOCCAGGIO POMPA CON CIRCUITO</td> <td>2</td> <td>PZ</td> </tr> </tbody> </table>	Codice	Descrizione	Qtà	UM	VL1128A0	VALVOLA VNR BARBED D6	2	PZ	VM2172A0	CLIP BLOCCAGGIO POMPA CON CIRCUITO	2	PZ																																																								
Codice	Descrizione	Qtà	UM																																																																						
VL1128A0	VALVOLA VNR BARBED D6	2	PZ																																																																						
VM2172A0	CLIP BLOCCAGGIO POMPA CON CIRCUITO	2	PZ																																																																						
			KVL1108A	KIT IMPIANTO LAVAGGIO ONE 04EU 1 GIR EUR	<table border="1"> <thead> <tr> <th>Codice</th> <th>Descrizione</th> <th>Qtà</th> <th>UM</th> </tr> </thead> <tbody> <tr> <td>0H7323A0</td> <td>LAMIERA SUPPORTO LAVAGGIO PLUS</td> <td>1</td> <td>PZ</td> </tr> <tr> <td>0H7511A0</td> <td>LAMIERA SUPPORTO LAVAGGIO ON</td> <td>1</td> <td>PZ</td> </tr> <tr> <td>EL1252A1</td> <td>ELETTROVALV OLA 1 VIA RID.VERDE JG D8-D10</td> <td>1</td> <td>PZ</td> </tr> <tr> <td>EL1424A0</td> <td>ELETTROVALV OLA H2O JG D8-PORTAGO MMA D6</td> <td>1</td> <td>PZ</td> </tr> <tr> <td>EL1436A0</td> <td>EV H2O JG D8-PORTAGO MMA D6 CHECK VALVE</td> <td>1</td> <td>PZ</td> </tr> <tr> <td>GN1526A0</td> <td>O-RING D.INT6.9 SP1.8</td> <td>1</td> <td>PZ</td> </tr> <tr> <td>RC1006A0</td> <td>CURVA GUIDA TUBO PET D8</td> <td>2</td> <td>PZ</td> </tr> <tr> <td>RC1019A0</td> <td>FASCETTA ELASTICA D10 ZINCATA</td> <td>11</td> <td>PZ</td> </tr> <tr> <td>RC1130A0</td> <td>FASCETTA 130X2,6</td> <td>1</td> <td>PZ</td> </tr> <tr> <td>RC1242A0</td> <td>TERMINALE CHIUSO D10</td> <td>2</td> <td>PZ</td> </tr> <tr> <td>RC1310A0</td> <td>FASCETTA RICHCO 140X4 CON CLIP</td> <td>2</td> <td>PZ</td> </tr> <tr> <td>RC1356A0</td> <td>RACCORDO DRITTO FIL. FEMM 8X1/4 BSP</td> <td>1</td> <td>PZ</td> </tr> <tr> <td>TB1818A0</td> <td>TUBO 8X4.75 PE BLU</td> <td>0.220</td> <td>M</td> </tr> <tr> <td>TB2820A0</td> <td>TUBO EPDM 6X10</td> <td>1.240</td> <td>M</td> </tr> <tr> <td>VI1220A1</td> <td>VITE AUTOFILETTA NTE 4.2X11 TCS+ MARUTE</td> <td>2</td> <td>PZ</td> </tr> <tr> <td>VL1019A0</td> <td>POMPA VIBRAZIONE</td> <td>1</td> <td>PZ</td> </tr> </tbody> </table>	Codice	Descrizione	Qtà	UM	0H7323A0	LAMIERA SUPPORTO LAVAGGIO PLUS	1	PZ	0H7511A0	LAMIERA SUPPORTO LAVAGGIO ON	1	PZ	EL1252A1	ELETTROVALV OLA 1 VIA RID.VERDE JG D8-D10	1	PZ	EL1424A0	ELETTROVALV OLA H2O JG D8-PORTAGO MMA D6	1	PZ	EL1436A0	EV H2O JG D8-PORTAGO MMA D6 CHECK VALVE	1	PZ	GN1526A0	O-RING D.INT6.9 SP1.8	1	PZ	RC1006A0	CURVA GUIDA TUBO PET D8	2	PZ	RC1019A0	FASCETTA ELASTICA D10 ZINCATA	11	PZ	RC1130A0	FASCETTA 130X2,6	1	PZ	RC1242A0	TERMINALE CHIUSO D10	2	PZ	RC1310A0	FASCETTA RICHCO 140X4 CON CLIP	2	PZ	RC1356A0	RACCORDO DRITTO FIL. FEMM 8X1/4 BSP	1	PZ	TB1818A0	TUBO 8X4.75 PE BLU	0.220	M	TB2820A0	TUBO EPDM 6X10	1.240	M	VI1220A1	VITE AUTOFILETTA NTE 4.2X11 TCS+ MARUTE	2	PZ	VL1019A0	POMPA VIBRAZIONE	1	PZ
Codice	Descrizione	Qtà	UM																																																																						
0H7323A0	LAMIERA SUPPORTO LAVAGGIO PLUS	1	PZ																																																																						
0H7511A0	LAMIERA SUPPORTO LAVAGGIO ON	1	PZ																																																																						
EL1252A1	ELETTROVALV OLA 1 VIA RID.VERDE JG D8-D10	1	PZ																																																																						
EL1424A0	ELETTROVALV OLA H2O JG D8-PORTAGO MMA D6	1	PZ																																																																						
EL1436A0	EV H2O JG D8-PORTAGO MMA D6 CHECK VALVE	1	PZ																																																																						
GN1526A0	O-RING D.INT6.9 SP1.8	1	PZ																																																																						
RC1006A0	CURVA GUIDA TUBO PET D8	2	PZ																																																																						
RC1019A0	FASCETTA ELASTICA D10 ZINCATA	11	PZ																																																																						
RC1130A0	FASCETTA 130X2,6	1	PZ																																																																						
RC1242A0	TERMINALE CHIUSO D10	2	PZ																																																																						
RC1310A0	FASCETTA RICHCO 140X4 CON CLIP	2	PZ																																																																						
RC1356A0	RACCORDO DRITTO FIL. FEMM 8X1/4 BSP	1	PZ																																																																						
TB1818A0	TUBO 8X4.75 PE BLU	0.220	M																																																																						
TB2820A0	TUBO EPDM 6X10	1.240	M																																																																						
VI1220A1	VITE AUTOFILETTA NTE 4.2X11 TCS+ MARUTE	2	PZ																																																																						
VL1019A0	POMPA VIBRAZIONE	1	PZ																																																																						

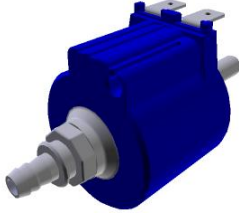
COMPONENTE			RICAMBIO																																																		
Codice	Descrizione	Immagine	Codice	Descrizione	Lista componenti																																																
VL1019A	POMPA VIBRAZIONE		KVL1108A	KIT IMPIANTO LAVAGGIO ONE 04EU 1 GIR EUR	<table border="1"> <thead> <tr> <th>Codice</th> <th>Descrizione</th> <th>Qtà</th> <th>UM</th> </tr> </thead> <tbody> <tr> <td>VL1053B0</td> <td>DISTRIBUTOR E USCITA LAVAGGIO ON</td> <td>1</td> <td>PZ</td> </tr> <tr> <td>VL1054B0</td> <td>DISTRIBUTOR E INGRESSI LAVAGGIO ON</td> <td>1</td> <td>PZ</td> </tr> <tr> <td>VL1064A0</td> <td>DISTRIBUTOR E USCITE CIRCUITO LAVAGGIO PL</td> <td>1</td> <td>PZ</td> </tr> <tr> <td>VL1065A1</td> <td>PRESSOSTAT O.N.O. 1/4 M CI</td> <td>1</td> <td>PZ</td> </tr> <tr> <td>VL1067A0</td> <td>DISTRIBUTOR E INGRESSI CIRCUITO LAVAGGIO</td> <td>1</td> <td>PZ</td> </tr> <tr> <td>VL1080A0</td> <td>FILTRO IN LINEA DETERGENTE</td> <td>1</td> <td>PZ</td> </tr> <tr> <td>VL1081A0</td> <td>VALVOLA NON RITORNO BARBED D6</td> <td>2</td> <td>PZ</td> </tr> <tr> <td>VL1083A0</td> <td>RACCORDO D10 - PORTAGOMM A BARBED D6</td> <td>1</td> <td>PZ</td> </tr> <tr> <td>VL1102A0</td> <td>FILTRO IN LINEA CON VNR BARBED 6 MM</td> <td>1</td> <td>PZ</td> </tr> <tr> <td>VL1128A0</td> <td>VALVOLA VNR BARBED D6</td> <td>1</td> <td>PZ</td> </tr> <tr> <td>VM2172A0</td> <td>CLIP BLOCCAGGIO POMPA CON CIRCUITO</td> <td>1</td> <td>PZ</td> </tr> </tbody> </table>	Codice	Descrizione	Qtà	UM	VL1053B0	DISTRIBUTOR E USCITA LAVAGGIO ON	1	PZ	VL1054B0	DISTRIBUTOR E INGRESSI LAVAGGIO ON	1	PZ	VL1064A0	DISTRIBUTOR E USCITE CIRCUITO LAVAGGIO PL	1	PZ	VL1065A1	PRESSOSTAT O.N.O. 1/4 M CI	1	PZ	VL1067A0	DISTRIBUTOR E INGRESSI CIRCUITO LAVAGGIO	1	PZ	VL1080A0	FILTRO IN LINEA DETERGENTE	1	PZ	VL1081A0	VALVOLA NON RITORNO BARBED D6	2	PZ	VL1083A0	RACCORDO D10 - PORTAGOMM A BARBED D6	1	PZ	VL1102A0	FILTRO IN LINEA CON VNR BARBED 6 MM	1	PZ	VL1128A0	VALVOLA VNR BARBED D6	1	PZ	VM2172A0	CLIP BLOCCAGGIO POMPA CON CIRCUITO	1	PZ
Codice	Descrizione	Qtà	UM																																																		
VL1053B0	DISTRIBUTOR E USCITA LAVAGGIO ON	1	PZ																																																		
VL1054B0	DISTRIBUTOR E INGRESSI LAVAGGIO ON	1	PZ																																																		
VL1064A0	DISTRIBUTOR E USCITE CIRCUITO LAVAGGIO PL	1	PZ																																																		
VL1065A1	PRESSOSTAT O.N.O. 1/4 M CI	1	PZ																																																		
VL1067A0	DISTRIBUTOR E INGRESSI CIRCUITO LAVAGGIO	1	PZ																																																		
VL1080A0	FILTRO IN LINEA DETERGENTE	1	PZ																																																		
VL1081A0	VALVOLA NON RITORNO BARBED D6	2	PZ																																																		
VL1083A0	RACCORDO D10 - PORTAGOMM A BARBED D6	1	PZ																																																		
VL1102A0	FILTRO IN LINEA CON VNR BARBED 6 MM	1	PZ																																																		
VL1128A0	VALVOLA VNR BARBED D6	1	PZ																																																		
VM2172A0	CLIP BLOCCAGGIO POMPA CON CIRCUITO	1	PZ																																																		
			KVL1107A	KIT IMPIANTO LAVAGGIO PLUS 04EU 1 GIR EU	<table border="1"> <thead> <tr> <th>Codice</th> <th>Descrizione</th> <th>Qtà</th> <th>UM</th> </tr> </thead> <tbody> <tr> <td>0H7323A0</td> <td>LAMIERA SUPPORTO LAVAGGIO PLUS</td> <td>1</td> <td>PZ</td> </tr> <tr> <td>EL1252A1</td> <td>ELETTROVALV OLA 1 VIA RID.VERDE JG D8-D10</td> <td>1</td> <td>PZ</td> </tr> <tr> <td>EL1424A0</td> <td>ELETTROVALV OLA H2O JG D8-PORTAGO MMA D6</td> <td>1</td> <td>PZ</td> </tr> <tr> <td>EL1436A0</td> <td>EV H2O JG D8-PORTAGO MMA D6 CHECK VALVE</td> <td>1</td> <td>PZ</td> </tr> </tbody> </table>	Codice	Descrizione	Qtà	UM	0H7323A0	LAMIERA SUPPORTO LAVAGGIO PLUS	1	PZ	EL1252A1	ELETTROVALV OLA 1 VIA RID.VERDE JG D8-D10	1	PZ	EL1424A0	ELETTROVALV OLA H2O JG D8-PORTAGO MMA D6	1	PZ	EL1436A0	EV H2O JG D8-PORTAGO MMA D6 CHECK VALVE	1	PZ																												
Codice	Descrizione	Qtà	UM																																																		
0H7323A0	LAMIERA SUPPORTO LAVAGGIO PLUS	1	PZ																																																		
EL1252A1	ELETTROVALV OLA 1 VIA RID.VERDE JG D8-D10	1	PZ																																																		
EL1424A0	ELETTROVALV OLA H2O JG D8-PORTAGO MMA D6	1	PZ																																																		
EL1436A0	EV H2O JG D8-PORTAGO MMA D6 CHECK VALVE	1	PZ																																																		

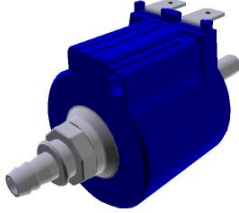
COMPONENTE			RICAMBIO																																																																																		
Codice	Descrizione	Immagine	Codice	Descrizione	Lista componenti																																																																																
VL1019A	POMPA VIBRAZIONE		KVL1107A	KIT IMPIANTO LAVAGGIO PLUS 04EU 1 GIR EU	<table border="1"> <thead> <tr> <th>Codice</th> <th>Descrizione</th> <th>Qtà</th> <th>UM</th> </tr> </thead> <tbody> <tr> <td>GN1526A0</td> <td>O-RING D.INT6.9 SP1.8</td> <td>1</td> <td>PZ</td> </tr> <tr> <td>RC1019A0</td> <td>FASCETTA ELASTICA D10 ZINCATA</td> <td>11</td> <td>PZ</td> </tr> <tr> <td>RC1130A0</td> <td>FASCETTA 130X2,6</td> <td>1</td> <td>PZ</td> </tr> <tr> <td>RC1242A0</td> <td>TERMINALE CHIUSO D10</td> <td>2</td> <td>PZ</td> </tr> <tr> <td>RC1310A0</td> <td>FASCETTA RICHCO 140X4 CON CLIP</td> <td>2</td> <td>PZ</td> </tr> <tr> <td>RC1356A0</td> <td>RACCORDO DRITTO FIL. FEMM 8X1/4 BSP</td> <td>1</td> <td>PZ</td> </tr> <tr> <td>TB2820A0</td> <td>TUBO EPDM 6X10</td> <td>2.040</td> <td>M</td> </tr> <tr> <td>VI1220A1</td> <td>VITE AUTOFILETTA NTE 4.2X11 TCS+ MARUTE</td> <td>2</td> <td>PZ</td> </tr> <tr> <td>VL1019A0</td> <td>POMPA VIBRAZIONE</td> <td>1</td> <td>PZ</td> </tr> <tr> <td>VL1064A0</td> <td>DISTRIBUTOR E USCITE CIRCUITO LAVAGGIO PL</td> <td>1</td> <td>PZ</td> </tr> <tr> <td>VL1065A1</td> <td>PRESSOSTAT O.N.O. 1/4 M CI</td> <td>1</td> <td>PZ</td> </tr> <tr> <td>VL1067A0</td> <td>DISTRIBUTOR E INGRESSI CIRCUITO LAVAGGIO</td> <td>1</td> <td>PZ</td> </tr> <tr> <td>VL1080A0</td> <td>FILTRO IN LINEA DETERGENTE</td> <td>1</td> <td>PZ</td> </tr> <tr> <td>VL1081A0</td> <td>VALVOLA NON RITORNO BARBED D6</td> <td>2</td> <td>PZ</td> </tr> <tr> <td>VL1083A0</td> <td>RACCORDO D10 - PORTAGOMM A BARBED D6</td> <td>1</td> <td>PZ</td> </tr> <tr> <td>VL1102A0</td> <td>FILTRO IN LINEA CON VNR BARBED 6 MM</td> <td>1</td> <td>PZ</td> </tr> <tr> <td>VL1102A1</td> <td>FILTRO IN LINEA DET. + VNR BARBED 6 MM</td> <td>1</td> <td>PZ</td> </tr> <tr> <td>VL1128A0</td> <td>VALVOLA VNR BARBED D6</td> <td>1</td> <td>PZ</td> </tr> <tr> <td>VM2172A0</td> <td>CLIP BLOCCAGGIO POMPA CON CIRCUITO</td> <td>1</td> <td>PZ</td> </tr> </tbody> </table>	Codice	Descrizione	Qtà	UM	GN1526A0	O-RING D.INT6.9 SP1.8	1	PZ	RC1019A0	FASCETTA ELASTICA D10 ZINCATA	11	PZ	RC1130A0	FASCETTA 130X2,6	1	PZ	RC1242A0	TERMINALE CHIUSO D10	2	PZ	RC1310A0	FASCETTA RICHCO 140X4 CON CLIP	2	PZ	RC1356A0	RACCORDO DRITTO FIL. FEMM 8X1/4 BSP	1	PZ	TB2820A0	TUBO EPDM 6X10	2.040	M	VI1220A1	VITE AUTOFILETTA NTE 4.2X11 TCS+ MARUTE	2	PZ	VL1019A0	POMPA VIBRAZIONE	1	PZ	VL1064A0	DISTRIBUTOR E USCITE CIRCUITO LAVAGGIO PL	1	PZ	VL1065A1	PRESSOSTAT O.N.O. 1/4 M CI	1	PZ	VL1067A0	DISTRIBUTOR E INGRESSI CIRCUITO LAVAGGIO	1	PZ	VL1080A0	FILTRO IN LINEA DETERGENTE	1	PZ	VL1081A0	VALVOLA NON RITORNO BARBED D6	2	PZ	VL1083A0	RACCORDO D10 - PORTAGOMM A BARBED D6	1	PZ	VL1102A0	FILTRO IN LINEA CON VNR BARBED 6 MM	1	PZ	VL1102A1	FILTRO IN LINEA DET. + VNR BARBED 6 MM	1	PZ	VL1128A0	VALVOLA VNR BARBED D6	1	PZ	VM2172A0	CLIP BLOCCAGGIO POMPA CON CIRCUITO	1	PZ
Codice	Descrizione	Qtà	UM																																																																																		
GN1526A0	O-RING D.INT6.9 SP1.8	1	PZ																																																																																		
RC1019A0	FASCETTA ELASTICA D10 ZINCATA	11	PZ																																																																																		
RC1130A0	FASCETTA 130X2,6	1	PZ																																																																																		
RC1242A0	TERMINALE CHIUSO D10	2	PZ																																																																																		
RC1310A0	FASCETTA RICHCO 140X4 CON CLIP	2	PZ																																																																																		
RC1356A0	RACCORDO DRITTO FIL. FEMM 8X1/4 BSP	1	PZ																																																																																		
TB2820A0	TUBO EPDM 6X10	2.040	M																																																																																		
VI1220A1	VITE AUTOFILETTA NTE 4.2X11 TCS+ MARUTE	2	PZ																																																																																		
VL1019A0	POMPA VIBRAZIONE	1	PZ																																																																																		
VL1064A0	DISTRIBUTOR E USCITE CIRCUITO LAVAGGIO PL	1	PZ																																																																																		
VL1065A1	PRESSOSTAT O.N.O. 1/4 M CI	1	PZ																																																																																		
VL1067A0	DISTRIBUTOR E INGRESSI CIRCUITO LAVAGGIO	1	PZ																																																																																		
VL1080A0	FILTRO IN LINEA DETERGENTE	1	PZ																																																																																		
VL1081A0	VALVOLA NON RITORNO BARBED D6	2	PZ																																																																																		
VL1083A0	RACCORDO D10 - PORTAGOMM A BARBED D6	1	PZ																																																																																		
VL1102A0	FILTRO IN LINEA CON VNR BARBED 6 MM	1	PZ																																																																																		
VL1102A1	FILTRO IN LINEA DET. + VNR BARBED 6 MM	1	PZ																																																																																		
VL1128A0	VALVOLA VNR BARBED D6	1	PZ																																																																																		
VM2172A0	CLIP BLOCCAGGIO POMPA CON CIRCUITO	1	PZ																																																																																		

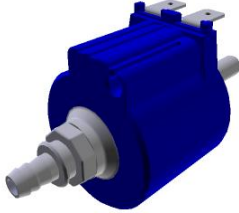
COMPONENTE			RICAMBIO																																																																														
Codice	Descrizione	Immagine	Codice	Descrizione	Lista componenti																																																																												
VL1019A	POMPA VIBRAZIONE		KVL1106A	KIT IMPIANTO LAVAGGIO ONE 1 GIRANTE EUR	<table border="1"> <thead> <tr> <th>Codice</th> <th>Descrizione</th> <th>Qtà</th> <th>UM</th> </tr> </thead> <tbody> <tr> <td>0H7324A0</td> <td>LAMIERA SUPPORTO LAVAGGIO ON</td> <td>1</td> <td>PZ</td> </tr> <tr> <td>0H7819A0</td> <td>SUPPORTO LAVAGGIO ONE CON ELV STEAM</td> <td>1</td> <td>PZ</td> </tr> <tr> <td>EL1436A0</td> <td>EV H2O JG D8-PORTAGO MMA D6 CHECK VALVE</td> <td>1</td> <td>PZ</td> </tr> <tr> <td>GN1526A0</td> <td>O-RING D.INT6.9 SP1.8</td> <td>1</td> <td>PZ</td> </tr> <tr> <td>RC1006A0</td> <td>CURVA GUIDA TUBO PET D8</td> <td>2</td> <td>PZ</td> </tr> <tr> <td>RC1019A0</td> <td>FASCETTA ELASTICA D10 ZINCATA</td> <td>15</td> <td>PZ</td> </tr> <tr> <td>RC1242A0</td> <td>TERMINALE CHIUSO D10</td> <td>2</td> <td>PZ</td> </tr> <tr> <td>RC1408A0</td> <td>FASCETTA BIFILARE A MOLLA D10.8 TUBO ZN</td> <td>2</td> <td>PZ</td> </tr> <tr> <td>TB1818A0</td> <td>TUBO 8X4.75 PE BLU</td> <td>0.320</td> <td>M</td> </tr> <tr> <td>TB2820A0</td> <td>TUBO EPDM 6X10</td> <td>1.380</td> <td>M</td> </tr> <tr> <td>VH1220A1</td> <td>VITE AUTOFILETTA NTE 4.2X11 TCS+ MARUTE</td> <td>1</td> <td>PZ</td> </tr> <tr> <td>VL1019A0</td> <td>POMPA VIBRAZIONE</td> <td>1</td> <td>PZ</td> </tr> <tr> <td>VL1053B0</td> <td>DISTRIBUTOR E USCITA LAVAGGIO ON</td> <td>1</td> <td>PZ</td> </tr> <tr> <td>VL1054B0</td> <td>DISTRIBUTOR E INGRESSI LAVAGGIO ON</td> <td>1</td> <td>PZ</td> </tr> <tr> <td>VL1080A0</td> <td>FILTRO IN LINEA DETERGENTE</td> <td>1</td> <td>PZ</td> </tr> <tr> <td>VL1081A0</td> <td>VALVOLA NON RITORNO BARBED D6</td> <td>1</td> <td>PZ</td> </tr> <tr> <td>VL1102A0</td> <td>FILTRO IN LINEA CON VNR BARBED 6 MM</td> <td>1</td> <td>PZ</td> </tr> <tr> <td>VL1102A1</td> <td>FILTRO IN LINEA DET. + VNR BARBED 6 MM</td> <td>1</td> <td>PZ</td> </tr> </tbody> </table>	Codice	Descrizione	Qtà	UM	0H7324A0	LAMIERA SUPPORTO LAVAGGIO ON	1	PZ	0H7819A0	SUPPORTO LAVAGGIO ONE CON ELV STEAM	1	PZ	EL1436A0	EV H2O JG D8-PORTAGO MMA D6 CHECK VALVE	1	PZ	GN1526A0	O-RING D.INT6.9 SP1.8	1	PZ	RC1006A0	CURVA GUIDA TUBO PET D8	2	PZ	RC1019A0	FASCETTA ELASTICA D10 ZINCATA	15	PZ	RC1242A0	TERMINALE CHIUSO D10	2	PZ	RC1408A0	FASCETTA BIFILARE A MOLLA D10.8 TUBO ZN	2	PZ	TB1818A0	TUBO 8X4.75 PE BLU	0.320	M	TB2820A0	TUBO EPDM 6X10	1.380	M	VH1220A1	VITE AUTOFILETTA NTE 4.2X11 TCS+ MARUTE	1	PZ	VL1019A0	POMPA VIBRAZIONE	1	PZ	VL1053B0	DISTRIBUTOR E USCITA LAVAGGIO ON	1	PZ	VL1054B0	DISTRIBUTOR E INGRESSI LAVAGGIO ON	1	PZ	VL1080A0	FILTRO IN LINEA DETERGENTE	1	PZ	VL1081A0	VALVOLA NON RITORNO BARBED D6	1	PZ	VL1102A0	FILTRO IN LINEA CON VNR BARBED 6 MM	1	PZ	VL1102A1	FILTRO IN LINEA DET. + VNR BARBED 6 MM	1	PZ
Codice	Descrizione	Qtà	UM																																																																														
0H7324A0	LAMIERA SUPPORTO LAVAGGIO ON	1	PZ																																																																														
0H7819A0	SUPPORTO LAVAGGIO ONE CON ELV STEAM	1	PZ																																																																														
EL1436A0	EV H2O JG D8-PORTAGO MMA D6 CHECK VALVE	1	PZ																																																																														
GN1526A0	O-RING D.INT6.9 SP1.8	1	PZ																																																																														
RC1006A0	CURVA GUIDA TUBO PET D8	2	PZ																																																																														
RC1019A0	FASCETTA ELASTICA D10 ZINCATA	15	PZ																																																																														
RC1242A0	TERMINALE CHIUSO D10	2	PZ																																																																														
RC1408A0	FASCETTA BIFILARE A MOLLA D10.8 TUBO ZN	2	PZ																																																																														
TB1818A0	TUBO 8X4.75 PE BLU	0.320	M																																																																														
TB2820A0	TUBO EPDM 6X10	1.380	M																																																																														
VH1220A1	VITE AUTOFILETTA NTE 4.2X11 TCS+ MARUTE	1	PZ																																																																														
VL1019A0	POMPA VIBRAZIONE	1	PZ																																																																														
VL1053B0	DISTRIBUTOR E USCITA LAVAGGIO ON	1	PZ																																																																														
VL1054B0	DISTRIBUTOR E INGRESSI LAVAGGIO ON	1	PZ																																																																														
VL1080A0	FILTRO IN LINEA DETERGENTE	1	PZ																																																																														
VL1081A0	VALVOLA NON RITORNO BARBED D6	1	PZ																																																																														
VL1102A0	FILTRO IN LINEA CON VNR BARBED 6 MM	1	PZ																																																																														
VL1102A1	FILTRO IN LINEA DET. + VNR BARBED 6 MM	1	PZ																																																																														

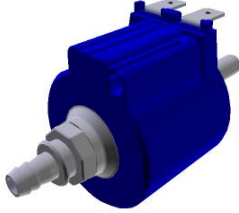
COMPONENTE			RICAMBIO																																																											
Codice	Descrizione	Immagine	Codice	Descrizione	Lista componenti																																																									
VL1019A	POMPA VIBRAZIONE		KVL1106A	KIT IMPIANTO LAVAGGIO ONE 1 GIRANTE EUR	<table border="1"> <thead> <tr> <th>Codice</th> <th>Descrizione</th> <th>Qtà</th> <th>UM</th> </tr> </thead> <tbody> <tr> <td>VL1128A0</td> <td>VALVOLA VNR BARBED D6</td> <td>1</td> <td>PZ</td> </tr> <tr> <td>VM2172A0</td> <td>CLIP BLOCCAGGIO POMPA CON CIRCUITO</td> <td>1</td> <td>PZ</td> </tr> </tbody> </table>	Codice	Descrizione	Qtà	UM	VL1128A0	VALVOLA VNR BARBED D6	1	PZ	VM2172A0	CLIP BLOCCAGGIO POMPA CON CIRCUITO	1	PZ																																													
			Codice	Descrizione	Qtà	UM																																																								
VL1128A0	VALVOLA VNR BARBED D6	1	PZ																																																											
VM2172A0	CLIP BLOCCAGGIO POMPA CON CIRCUITO	1	PZ																																																											
KVL1105A	KIT IMPIANTO LAVAGGIO PLUS 2 GIRANTI USA	<table border="1"> <thead> <tr> <th>Codice</th> <th>Descrizione</th> <th>Qtà</th> <th>UM</th> </tr> </thead> <tbody> <tr> <td>0H7323A0</td> <td>LAMIERA SUPPORTO LAVAGGIO PLUS</td> <td>1</td> <td>PZ</td> </tr> <tr> <td>0H7820A0</td> <td>SUPPORTO LAVAGGIO PLUS CON ELV STEAM</td> <td>1</td> <td>PZ</td> </tr> <tr> <td>EL1020A1</td> <td>RACCORDO INTERMEDIO "T" TUBO D8 J</td> <td>1</td> <td>PZ</td> </tr> <tr> <td>EL1422A0</td> <td>ELETTROVALV 1 VIA RID.VERDE JG D8-D10 UL</td> <td>1</td> <td>PZ</td> </tr> <tr> <td>EL1422A1</td> <td>ELETTROVALV 1 VIA RID.VERDE JG D8-D10 UL</td> <td>1</td> <td>PZ</td> </tr> <tr> <td>EL1426A0</td> <td>ELETTROVALV OLA UL H2O JG D8-PORTAGO MMA D</td> <td>2</td> <td>PZ</td> </tr> <tr> <td>EL1437A0</td> <td>EV H2O JG D8-PORTAGO MMA D6 CH. VALVE UL</td> <td>1</td> <td>PZ</td> </tr> <tr> <td>GN1526A0</td> <td>O-RING D.INT6.9 SP1.8</td> <td>1</td> <td>PZ</td> </tr> <tr> <td>RC1019A0</td> <td>FASCETTA ELASTICA D10 ZINCATA</td> <td>12</td> <td>PZ</td> </tr> <tr> <td>RC1130A0</td> <td>FASCETTA 130X2,6</td> <td>1</td> <td>PZ</td> </tr> <tr> <td>RC1242A0</td> <td>TERMINALE CHIUSO D10</td> <td>2</td> <td>PZ</td> </tr> <tr> <td>RC1310A0</td> <td>FASCETTA RICHCO 140X4 CON CLIP</td> <td>2</td> <td>PZ</td> </tr> <tr> <td>RC1356A0</td> <td>RACCORDO DRITTO FIL. FEMM 8X1/4 BSP</td> <td>1</td> <td>PZ</td> </tr> <tr> <td>RC1408A0</td> <td>FASCETTA BIFILARE A MOLLA D10.8 TUBO ZN</td> <td>2</td> <td>PZ</td> </tr> </tbody> </table>	Codice	Descrizione	Qtà	UM	0H7323A0	LAMIERA SUPPORTO LAVAGGIO PLUS	1	PZ	0H7820A0	SUPPORTO LAVAGGIO PLUS CON ELV STEAM	1	PZ	EL1020A1	RACCORDO INTERMEDIO "T" TUBO D8 J	1	PZ	EL1422A0	ELETTROVALV 1 VIA RID.VERDE JG D8-D10 UL	1	PZ	EL1422A1	ELETTROVALV 1 VIA RID.VERDE JG D8-D10 UL	1	PZ	EL1426A0	ELETTROVALV OLA UL H2O JG D8-PORTAGO MMA D	2	PZ	EL1437A0	EV H2O JG D8-PORTAGO MMA D6 CH. VALVE UL	1	PZ	GN1526A0	O-RING D.INT6.9 SP1.8	1	PZ	RC1019A0	FASCETTA ELASTICA D10 ZINCATA	12	PZ	RC1130A0	FASCETTA 130X2,6	1	PZ	RC1242A0	TERMINALE CHIUSO D10	2	PZ	RC1310A0	FASCETTA RICHCO 140X4 CON CLIP	2	PZ	RC1356A0	RACCORDO DRITTO FIL. FEMM 8X1/4 BSP	1	PZ	RC1408A0	FASCETTA BIFILARE A MOLLA D10.8 TUBO ZN	2	PZ
Codice	Descrizione	Qtà	UM																																																											
0H7323A0	LAMIERA SUPPORTO LAVAGGIO PLUS	1	PZ																																																											
0H7820A0	SUPPORTO LAVAGGIO PLUS CON ELV STEAM	1	PZ																																																											
EL1020A1	RACCORDO INTERMEDIO "T" TUBO D8 J	1	PZ																																																											
EL1422A0	ELETTROVALV 1 VIA RID.VERDE JG D8-D10 UL	1	PZ																																																											
EL1422A1	ELETTROVALV 1 VIA RID.VERDE JG D8-D10 UL	1	PZ																																																											
EL1426A0	ELETTROVALV OLA UL H2O JG D8-PORTAGO MMA D	2	PZ																																																											
EL1437A0	EV H2O JG D8-PORTAGO MMA D6 CH. VALVE UL	1	PZ																																																											
GN1526A0	O-RING D.INT6.9 SP1.8	1	PZ																																																											
RC1019A0	FASCETTA ELASTICA D10 ZINCATA	12	PZ																																																											
RC1130A0	FASCETTA 130X2,6	1	PZ																																																											
RC1242A0	TERMINALE CHIUSO D10	2	PZ																																																											
RC1310A0	FASCETTA RICHCO 140X4 CON CLIP	2	PZ																																																											
RC1356A0	RACCORDO DRITTO FIL. FEMM 8X1/4 BSP	1	PZ																																																											
RC1408A0	FASCETTA BIFILARE A MOLLA D10.8 TUBO ZN	2	PZ																																																											

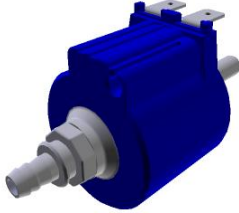
COMPONENTE			RICAMBIO																																																														
Codice	Descrizione	Immagine	Codice	Descrizione	Lista componenti																																																												
VL1019A	POMPA VIBRAZIONE		KVL1105A	KIT IMPIANTO LAVAGGIO PLUS 2 GIRANTI USA	<table border="1"> <thead> <tr> <th>Codice</th> <th>Descrizione</th> <th>Qtà</th> <th>UM</th> </tr> </thead> <tbody> <tr> <td>TB1818A0</td> <td>TUBO 8X4.75 PE BLU</td> <td>0.300</td> <td>M</td> </tr> <tr> <td>TB2820A0</td> <td>TUBO EPDM 6X10</td> <td>2.040</td> <td>M</td> </tr> <tr> <td>VI1220A1</td> <td>VITE AUTOFILETTA NTE 4.2X11 TCS+ MARUTE</td> <td>2</td> <td>PZ</td> </tr> <tr> <td>VL1019A0</td> <td>POMPA VIBRAZIONE</td> <td>1</td> <td>PZ</td> </tr> <tr> <td>VL1065A1</td> <td>PRESSOSTAT O.N.O. 1/4 M CI</td> <td>1</td> <td>PZ</td> </tr> <tr> <td>VL1067A0</td> <td>DISTRIBUTOR E INGRESSI CIRCUITO LAVAGGIO</td> <td>1</td> <td>PZ</td> </tr> <tr> <td>VL1080A0</td> <td>FILTRO IN LINEA DETERGENTE</td> <td>1</td> <td>PZ</td> </tr> <tr> <td>VL1081A0</td> <td>VALVOLA NON RITORNO BARBED D6</td> <td>2</td> <td>PZ</td> </tr> <tr> <td>VL1083A0</td> <td>RACCORDO D10 - PORTAGOMM A BARBED D6</td> <td>1</td> <td>PZ</td> </tr> <tr> <td>VL1092A0</td> <td>DISTRIBUTOR E USCITE LAVAGGIO PLUS DOPPIA</td> <td>1</td> <td>PZ</td> </tr> <tr> <td>VL1102A0</td> <td>FILTRO IN LINEA CON VNR BARBED 6 MM</td> <td>1</td> <td>PZ</td> </tr> <tr> <td>VL1102A1</td> <td>FILTRO IN LINEA DET. + VNR BARBED 6 MM</td> <td>1</td> <td>PZ</td> </tr> <tr> <td>VL1128A0</td> <td>VALVOLA VNR BARBED D6</td> <td>1</td> <td>PZ</td> </tr> <tr> <td>VM2172A0</td> <td>CLIP BLOCCAGGIO POMPA CON CIRCUITO</td> <td>1</td> <td>PZ</td> </tr> </tbody> </table>	Codice	Descrizione	Qtà	UM	TB1818A0	TUBO 8X4.75 PE BLU	0.300	M	TB2820A0	TUBO EPDM 6X10	2.040	M	VI1220A1	VITE AUTOFILETTA NTE 4.2X11 TCS+ MARUTE	2	PZ	VL1019A0	POMPA VIBRAZIONE	1	PZ	VL1065A1	PRESSOSTAT O.N.O. 1/4 M CI	1	PZ	VL1067A0	DISTRIBUTOR E INGRESSI CIRCUITO LAVAGGIO	1	PZ	VL1080A0	FILTRO IN LINEA DETERGENTE	1	PZ	VL1081A0	VALVOLA NON RITORNO BARBED D6	2	PZ	VL1083A0	RACCORDO D10 - PORTAGOMM A BARBED D6	1	PZ	VL1092A0	DISTRIBUTOR E USCITE LAVAGGIO PLUS DOPPIA	1	PZ	VL1102A0	FILTRO IN LINEA CON VNR BARBED 6 MM	1	PZ	VL1102A1	FILTRO IN LINEA DET. + VNR BARBED 6 MM	1	PZ	VL1128A0	VALVOLA VNR BARBED D6	1	PZ	VM2172A0	CLIP BLOCCAGGIO POMPA CON CIRCUITO	1	PZ
Codice	Descrizione	Qtà	UM																																																														
TB1818A0	TUBO 8X4.75 PE BLU	0.300	M																																																														
TB2820A0	TUBO EPDM 6X10	2.040	M																																																														
VI1220A1	VITE AUTOFILETTA NTE 4.2X11 TCS+ MARUTE	2	PZ																																																														
VL1019A0	POMPA VIBRAZIONE	1	PZ																																																														
VL1065A1	PRESSOSTAT O.N.O. 1/4 M CI	1	PZ																																																														
VL1067A0	DISTRIBUTOR E INGRESSI CIRCUITO LAVAGGIO	1	PZ																																																														
VL1080A0	FILTRO IN LINEA DETERGENTE	1	PZ																																																														
VL1081A0	VALVOLA NON RITORNO BARBED D6	2	PZ																																																														
VL1083A0	RACCORDO D10 - PORTAGOMM A BARBED D6	1	PZ																																																														
VL1092A0	DISTRIBUTOR E USCITE LAVAGGIO PLUS DOPPIA	1	PZ																																																														
VL1102A0	FILTRO IN LINEA CON VNR BARBED 6 MM	1	PZ																																																														
VL1102A1	FILTRO IN LINEA DET. + VNR BARBED 6 MM	1	PZ																																																														
VL1128A0	VALVOLA VNR BARBED D6	1	PZ																																																														
VM2172A0	CLIP BLOCCAGGIO POMPA CON CIRCUITO	1	PZ																																																														
			KVL1104A	KIT IMPIANTO LAVAGGIO PLUS 1 GIRANTE USA	<table border="1"> <thead> <tr> <th>Codice</th> <th>Descrizione</th> <th>Qtà</th> <th>UM</th> </tr> </thead> <tbody> <tr> <td>0H7323A0</td> <td>LAMIERA SUPPORTO LAVAGGIO PLUS</td> <td>1</td> <td>PZ</td> </tr> <tr> <td>0H7820A0</td> <td>SUPPORTO LAVAGGIO PLUS CON ELV STEAM</td> <td>1</td> <td>PZ</td> </tr> </tbody> </table>	Codice	Descrizione	Qtà	UM	0H7323A0	LAMIERA SUPPORTO LAVAGGIO PLUS	1	PZ	0H7820A0	SUPPORTO LAVAGGIO PLUS CON ELV STEAM	1	PZ																																																
Codice	Descrizione	Qtà	UM																																																														
0H7323A0	LAMIERA SUPPORTO LAVAGGIO PLUS	1	PZ																																																														
0H7820A0	SUPPORTO LAVAGGIO PLUS CON ELV STEAM	1	PZ																																																														

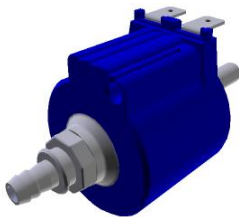
COMPONENTE			RICAMBIO																																																																										
Codice	Descrizione	Immagine	Codice	Descrizione	Lista componenti																																																																								
VL1019A	POMPA VIBRAZIONE		KVL1104A	KIT IMPIANTO LAVAGGIO PLUS 1 GIRANTE USA	<table border="1"> <thead> <tr> <th>Codice</th> <th>Descrizione</th> <th>Qtà</th> <th>UM</th> </tr> </thead> <tbody> <tr> <td>EL1020A1</td> <td>RACCORDO INTERMEDIO "T" TUBO D8 J</td> <td>1</td> <td>PZ</td> </tr> <tr> <td>EL1422A0</td> <td>ELETTROVALV 1 VIA RID.VERDE JG D8-D10 UL</td> <td>1</td> <td>PZ</td> </tr> <tr> <td>EL1422A1</td> <td>ELETTROVALV 1 VIA RID.VERDE JG D8-D10 UL</td> <td>1</td> <td>PZ</td> </tr> <tr> <td>EL1426A0</td> <td>ELETTROVALV 1 OLA UL H2O JG D8-PORTAGO MMA D</td> <td>1</td> <td>PZ</td> </tr> <tr> <td>EL1437A0</td> <td>EV H2O JG D8-PORTAGO MMA D6 CH. VALVE UL</td> <td>1</td> <td>PZ</td> </tr> <tr> <td>GN1526A0</td> <td>O-RING D.INT6.9 SP1.8</td> <td>1</td> <td>PZ</td> </tr> <tr> <td>RC1019A0</td> <td>FASCETTA ELASTICA D10 ZINCATA</td> <td>11</td> <td>PZ</td> </tr> <tr> <td>RC1130A0</td> <td>FASCETTA 130X2,6</td> <td>1</td> <td>PZ</td> </tr> <tr> <td>RC1242A0</td> <td>TERMINALE CHIUSO D10</td> <td>2</td> <td>PZ</td> </tr> <tr> <td>RC1310A0</td> <td>FASCETTA RICHCO 140X4 CON CLIP</td> <td>2</td> <td>PZ</td> </tr> <tr> <td>RC1356A0</td> <td>RACCORDO DRITTO FIL. FEMM 8X1/4 BSP</td> <td>1</td> <td>PZ</td> </tr> <tr> <td>RC1408A0</td> <td>FASCETTA BIFILARE A MOLLA D10.8 TUBO ZN</td> <td>2</td> <td>PZ</td> </tr> <tr> <td>TB1818A0</td> <td>TUBO 8X4.75 PE BLU</td> <td>0.300</td> <td>M</td> </tr> <tr> <td>TB2820A0</td> <td>TUBO EPDM 6X10</td> <td>1.240</td> <td>M</td> </tr> <tr> <td>VI1220A1</td> <td>VITE AUTOFILETTA NTE 4.2X11 TCS+ MARUTE</td> <td>2</td> <td>PZ</td> </tr> <tr> <td>VL1019A0</td> <td>POMPA VIBRAZIONE</td> <td>1</td> <td>PZ</td> </tr> <tr> <td>VL1064A0</td> <td>DISTRIBUTOR E USCITE CIRCUITO LAVAGGIO PL</td> <td>1</td> <td>PZ</td> </tr> </tbody> </table>	Codice	Descrizione	Qtà	UM	EL1020A1	RACCORDO INTERMEDIO "T" TUBO D8 J	1	PZ	EL1422A0	ELETTROVALV 1 VIA RID.VERDE JG D8-D10 UL	1	PZ	EL1422A1	ELETTROVALV 1 VIA RID.VERDE JG D8-D10 UL	1	PZ	EL1426A0	ELETTROVALV 1 OLA UL H2O JG D8-PORTAGO MMA D	1	PZ	EL1437A0	EV H2O JG D8-PORTAGO MMA D6 CH. VALVE UL	1	PZ	GN1526A0	O-RING D.INT6.9 SP1.8	1	PZ	RC1019A0	FASCETTA ELASTICA D10 ZINCATA	11	PZ	RC1130A0	FASCETTA 130X2,6	1	PZ	RC1242A0	TERMINALE CHIUSO D10	2	PZ	RC1310A0	FASCETTA RICHCO 140X4 CON CLIP	2	PZ	RC1356A0	RACCORDO DRITTO FIL. FEMM 8X1/4 BSP	1	PZ	RC1408A0	FASCETTA BIFILARE A MOLLA D10.8 TUBO ZN	2	PZ	TB1818A0	TUBO 8X4.75 PE BLU	0.300	M	TB2820A0	TUBO EPDM 6X10	1.240	M	VI1220A1	VITE AUTOFILETTA NTE 4.2X11 TCS+ MARUTE	2	PZ	VL1019A0	POMPA VIBRAZIONE	1	PZ	VL1064A0	DISTRIBUTOR E USCITE CIRCUITO LAVAGGIO PL	1	PZ
Codice	Descrizione	Qtà	UM																																																																										
EL1020A1	RACCORDO INTERMEDIO "T" TUBO D8 J	1	PZ																																																																										
EL1422A0	ELETTROVALV 1 VIA RID.VERDE JG D8-D10 UL	1	PZ																																																																										
EL1422A1	ELETTROVALV 1 VIA RID.VERDE JG D8-D10 UL	1	PZ																																																																										
EL1426A0	ELETTROVALV 1 OLA UL H2O JG D8-PORTAGO MMA D	1	PZ																																																																										
EL1437A0	EV H2O JG D8-PORTAGO MMA D6 CH. VALVE UL	1	PZ																																																																										
GN1526A0	O-RING D.INT6.9 SP1.8	1	PZ																																																																										
RC1019A0	FASCETTA ELASTICA D10 ZINCATA	11	PZ																																																																										
RC1130A0	FASCETTA 130X2,6	1	PZ																																																																										
RC1242A0	TERMINALE CHIUSO D10	2	PZ																																																																										
RC1310A0	FASCETTA RICHCO 140X4 CON CLIP	2	PZ																																																																										
RC1356A0	RACCORDO DRITTO FIL. FEMM 8X1/4 BSP	1	PZ																																																																										
RC1408A0	FASCETTA BIFILARE A MOLLA D10.8 TUBO ZN	2	PZ																																																																										
TB1818A0	TUBO 8X4.75 PE BLU	0.300	M																																																																										
TB2820A0	TUBO EPDM 6X10	1.240	M																																																																										
VI1220A1	VITE AUTOFILETTA NTE 4.2X11 TCS+ MARUTE	2	PZ																																																																										
VL1019A0	POMPA VIBRAZIONE	1	PZ																																																																										
VL1064A0	DISTRIBUTOR E USCITE CIRCUITO LAVAGGIO PL	1	PZ																																																																										

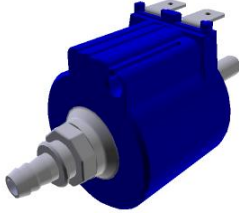
COMPONENTE			RICAMBIO																																										
Codice	Descrizione	Immagine	Codice	Descrizione	Lista componenti																																								
VL1019A	POMPA VIBRAZIONE		KVL1104A	KIT IMPIANTO LAVAGGIO PLUS 1 GIRANTE USA	<table border="1"> <thead> <tr> <th>Codice</th> <th>Descrizione</th> <th>Qtà</th> <th>UM</th> </tr> </thead> <tbody> <tr> <td>VL1065A1</td> <td>PRESSOSTAT O.N.O. 1/4 M CI</td> <td>1</td> <td>PZ</td> </tr> <tr> <td>VL1067A0</td> <td>DISTRIBUTOR E INGRESSI CIRCUITO LAVAGGIO</td> <td>1</td> <td>PZ</td> </tr> <tr> <td>VL1080A0</td> <td>FILTRO IN LINEA DETERGENTE</td> <td>1</td> <td>PZ</td> </tr> <tr> <td>VL1081A0</td> <td>VALVOLA NON RITORNO BARBED D6</td> <td>2</td> <td>PZ</td> </tr> <tr> <td>VL1083A0</td> <td>RACCORDO D10 - PORTAGOMM A BARBED D6</td> <td>1</td> <td>PZ</td> </tr> <tr> <td>VL1102A0</td> <td>FILTRO IN LINEA CON VNR BARBED 6 MM</td> <td>1</td> <td>PZ</td> </tr> <tr> <td>VL1102A1</td> <td>FILTRO IN LINEA DET. + VNR BARBED 6 MM</td> <td>1</td> <td>PZ</td> </tr> <tr> <td>VL1128A0</td> <td>VALVOLA VNR BARBED D6</td> <td>1</td> <td>PZ</td> </tr> <tr> <td>VM2172A0</td> <td>CLIP BLOCCAGGIO POMPA CON CIRCUITO</td> <td>1</td> <td>PZ</td> </tr> </tbody> </table>	Codice	Descrizione	Qtà	UM	VL1065A1	PRESSOSTAT O.N.O. 1/4 M CI	1	PZ	VL1067A0	DISTRIBUTOR E INGRESSI CIRCUITO LAVAGGIO	1	PZ	VL1080A0	FILTRO IN LINEA DETERGENTE	1	PZ	VL1081A0	VALVOLA NON RITORNO BARBED D6	2	PZ	VL1083A0	RACCORDO D10 - PORTAGOMM A BARBED D6	1	PZ	VL1102A0	FILTRO IN LINEA CON VNR BARBED 6 MM	1	PZ	VL1102A1	FILTRO IN LINEA DET. + VNR BARBED 6 MM	1	PZ	VL1128A0	VALVOLA VNR BARBED D6	1	PZ	VM2172A0	CLIP BLOCCAGGIO POMPA CON CIRCUITO	1	PZ
			Codice	Descrizione	Qtà	UM																																							
VL1065A1	PRESSOSTAT O.N.O. 1/4 M CI	1	PZ																																										
VL1067A0	DISTRIBUTOR E INGRESSI CIRCUITO LAVAGGIO	1	PZ																																										
VL1080A0	FILTRO IN LINEA DETERGENTE	1	PZ																																										
VL1081A0	VALVOLA NON RITORNO BARBED D6	2	PZ																																										
VL1083A0	RACCORDO D10 - PORTAGOMM A BARBED D6	1	PZ																																										
VL1102A0	FILTRO IN LINEA CON VNR BARBED 6 MM	1	PZ																																										
VL1102A1	FILTRO IN LINEA DET. + VNR BARBED 6 MM	1	PZ																																										
VL1128A0	VALVOLA VNR BARBED D6	1	PZ																																										
VM2172A0	CLIP BLOCCAGGIO POMPA CON CIRCUITO	1	PZ																																										
KVL1103A	KIT IMPIANTO LAVAGGIO PLUS 2 GIRANTI EUR	<table border="1"> <thead> <tr> <th>Codice</th> <th>Descrizione</th> <th>Qtà</th> <th>UM</th> </tr> </thead> <tbody> <tr> <td>0H7323A0</td> <td>LAMIERA SUPPORTO LAVAGGIO PLUS</td> <td>1</td> <td>PZ</td> </tr> <tr> <td>0H7820A0</td> <td>SUPPORTO LAVAGGIO PLUS CON ELV STEAM</td> <td>1</td> <td>PZ</td> </tr> <tr> <td>EL1252A1</td> <td>ELETTROVALV OLA 1 VIA RID.VERDE JG D8-D10</td> <td>1</td> <td>PZ</td> </tr> <tr> <td>EL1424A0</td> <td>ELETTROVALV OLA H2O JG D8-PORTAGO MMA D6</td> <td>2</td> <td>PZ</td> </tr> <tr> <td>EL1436A0</td> <td>EV H2O JG D8-PORTAGO MMA D6 CHECK VALVE</td> <td>1</td> <td>PZ</td> </tr> <tr> <td>GN1526A0</td> <td>O-RING D.INT6.9 SP1.8</td> <td>1</td> <td>PZ</td> </tr> </tbody> </table>	Codice	Descrizione	Qtà	UM	0H7323A0	LAMIERA SUPPORTO LAVAGGIO PLUS	1	PZ	0H7820A0	SUPPORTO LAVAGGIO PLUS CON ELV STEAM	1	PZ	EL1252A1	ELETTROVALV OLA 1 VIA RID.VERDE JG D8-D10	1	PZ	EL1424A0	ELETTROVALV OLA H2O JG D8-PORTAGO MMA D6	2	PZ	EL1436A0	EV H2O JG D8-PORTAGO MMA D6 CHECK VALVE	1	PZ	GN1526A0	O-RING D.INT6.9 SP1.8	1	PZ															
Codice	Descrizione	Qtà	UM																																										
0H7323A0	LAMIERA SUPPORTO LAVAGGIO PLUS	1	PZ																																										
0H7820A0	SUPPORTO LAVAGGIO PLUS CON ELV STEAM	1	PZ																																										
EL1252A1	ELETTROVALV OLA 1 VIA RID.VERDE JG D8-D10	1	PZ																																										
EL1424A0	ELETTROVALV OLA H2O JG D8-PORTAGO MMA D6	2	PZ																																										
EL1436A0	EV H2O JG D8-PORTAGO MMA D6 CHECK VALVE	1	PZ																																										
GN1526A0	O-RING D.INT6.9 SP1.8	1	PZ																																										

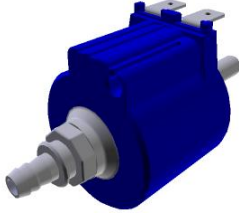
COMPONENTE			RICAMBIO																																																																										
Codice	Descrizione	Immagine	Codice	Descrizione	Lista componenti																																																																								
VL1019A	POMPA VIBRAZIONE		KVL1103A	KIT IMPIANTO LAVAGGIO PLUS 2 GIRANTI EUR	<table border="1"> <thead> <tr> <th>Codice</th> <th>Descrizione</th> <th>Qtà</th> <th>UM</th> </tr> </thead> <tbody> <tr> <td>RC1019A0</td> <td>FASCETTA ELASTICA D10 ZINCATA</td> <td>12</td> <td>PZ</td> </tr> <tr> <td>RC1130A0</td> <td>FASCETTA 130X2,6</td> <td>1</td> <td>PZ</td> </tr> <tr> <td>RC1242A0</td> <td>TERMINALE CHIUSO D10</td> <td>2</td> <td>PZ</td> </tr> <tr> <td>RC1310A0</td> <td>FASCETTA RICHCO 140X4 CON CLIP</td> <td>2</td> <td>PZ</td> </tr> <tr> <td>RC1356A0</td> <td>RACCORDO DRITTO FIL. FEMM 8X1/4 BSP</td> <td>1</td> <td>PZ</td> </tr> <tr> <td>RC1408A0</td> <td>FASCETTA BIFILARE A MOLLA D10.8 TUBO ZN</td> <td>2</td> <td>PZ</td> </tr> <tr> <td>TB1818A0</td> <td>TUBO 8X4.75 PE BLU</td> <td>0.220</td> <td>M</td> </tr> <tr> <td>TB2820A0</td> <td>TUBO EPDM 6X10</td> <td>2.040</td> <td>M</td> </tr> <tr> <td>VI1220A1</td> <td>VITE AUTOFILETTA NTE 4.2X11 TCS+ MARUTE</td> <td>2</td> <td>PZ</td> </tr> <tr> <td>VL1019A0</td> <td>POMPA VIBRAZIONE</td> <td>1</td> <td>PZ</td> </tr> <tr> <td>VL1065A1</td> <td>PRESSOSTAT O.N.O. 1/4 M CI</td> <td>1</td> <td>PZ</td> </tr> <tr> <td>VL1067A0</td> <td>DISTRIBUTOR E INGRESSI CIRCUITO LAVAGGIO</td> <td>1</td> <td>PZ</td> </tr> <tr> <td>VL1080A0</td> <td>FILTRO IN LINEA DETERGENTE</td> <td>1</td> <td>PZ</td> </tr> <tr> <td>VL1081A0</td> <td>VALVOLA NON RITORNO BARBED D6</td> <td>2</td> <td>PZ</td> </tr> <tr> <td>VL1083A0</td> <td>RACCORDO D10 - PORTAGOMM A BARBED D6</td> <td>1</td> <td>PZ</td> </tr> <tr> <td>VL1092A0</td> <td>DISTRIBUTOR E USCITE LAVAGGIO PLUS DOPPIA</td> <td>1</td> <td>PZ</td> </tr> <tr> <td>VL1102A0</td> <td>FILTRO IN LINEA CON VNR BARBED 6 MM</td> <td>1</td> <td>PZ</td> </tr> </tbody> </table>	Codice	Descrizione	Qtà	UM	RC1019A0	FASCETTA ELASTICA D10 ZINCATA	12	PZ	RC1130A0	FASCETTA 130X2,6	1	PZ	RC1242A0	TERMINALE CHIUSO D10	2	PZ	RC1310A0	FASCETTA RICHCO 140X4 CON CLIP	2	PZ	RC1356A0	RACCORDO DRITTO FIL. FEMM 8X1/4 BSP	1	PZ	RC1408A0	FASCETTA BIFILARE A MOLLA D10.8 TUBO ZN	2	PZ	TB1818A0	TUBO 8X4.75 PE BLU	0.220	M	TB2820A0	TUBO EPDM 6X10	2.040	M	VI1220A1	VITE AUTOFILETTA NTE 4.2X11 TCS+ MARUTE	2	PZ	VL1019A0	POMPA VIBRAZIONE	1	PZ	VL1065A1	PRESSOSTAT O.N.O. 1/4 M CI	1	PZ	VL1067A0	DISTRIBUTOR E INGRESSI CIRCUITO LAVAGGIO	1	PZ	VL1080A0	FILTRO IN LINEA DETERGENTE	1	PZ	VL1081A0	VALVOLA NON RITORNO BARBED D6	2	PZ	VL1083A0	RACCORDO D10 - PORTAGOMM A BARBED D6	1	PZ	VL1092A0	DISTRIBUTOR E USCITE LAVAGGIO PLUS DOPPIA	1	PZ	VL1102A0	FILTRO IN LINEA CON VNR BARBED 6 MM	1	PZ
Codice	Descrizione	Qtà	UM																																																																										
RC1019A0	FASCETTA ELASTICA D10 ZINCATA	12	PZ																																																																										
RC1130A0	FASCETTA 130X2,6	1	PZ																																																																										
RC1242A0	TERMINALE CHIUSO D10	2	PZ																																																																										
RC1310A0	FASCETTA RICHCO 140X4 CON CLIP	2	PZ																																																																										
RC1356A0	RACCORDO DRITTO FIL. FEMM 8X1/4 BSP	1	PZ																																																																										
RC1408A0	FASCETTA BIFILARE A MOLLA D10.8 TUBO ZN	2	PZ																																																																										
TB1818A0	TUBO 8X4.75 PE BLU	0.220	M																																																																										
TB2820A0	TUBO EPDM 6X10	2.040	M																																																																										
VI1220A1	VITE AUTOFILETTA NTE 4.2X11 TCS+ MARUTE	2	PZ																																																																										
VL1019A0	POMPA VIBRAZIONE	1	PZ																																																																										
VL1065A1	PRESSOSTAT O.N.O. 1/4 M CI	1	PZ																																																																										
VL1067A0	DISTRIBUTOR E INGRESSI CIRCUITO LAVAGGIO	1	PZ																																																																										
VL1080A0	FILTRO IN LINEA DETERGENTE	1	PZ																																																																										
VL1081A0	VALVOLA NON RITORNO BARBED D6	2	PZ																																																																										
VL1083A0	RACCORDO D10 - PORTAGOMM A BARBED D6	1	PZ																																																																										
VL1092A0	DISTRIBUTOR E USCITE LAVAGGIO PLUS DOPPIA	1	PZ																																																																										
VL1102A0	FILTRO IN LINEA CON VNR BARBED 6 MM	1	PZ																																																																										

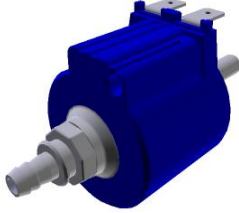
COMPONENTE			RICAMBIO																																																														
Codice	Descrizione	Immagine	Codice	Descrizione	Lista componenti																																																												
VL1019A	POMPA VIBRAZIONE		KVL1103A	KIT IMPIANTO LAVAGGIO PLUS 2 GIRANTI EUR	<table border="1"> <thead> <tr> <th>Codice</th> <th>Descrizione</th> <th>Qtà</th> <th>UM</th> </tr> </thead> <tbody> <tr> <td>VL1102A1</td> <td>FILTRO IN LINEA DET. + VNR BARBED 6 MM</td> <td>1</td> <td>PZ</td> </tr> <tr> <td>VL1128A0</td> <td>VALVOLA VNR BARBED D6</td> <td>1</td> <td>PZ</td> </tr> <tr> <td>VM2172A0</td> <td>CLIP BLOCCAGGIO POMPA CON CIRCUITO</td> <td>1</td> <td>PZ</td> </tr> </tbody> </table>	Codice	Descrizione	Qtà	UM	VL1102A1	FILTRO IN LINEA DET. + VNR BARBED 6 MM	1	PZ	VL1128A0	VALVOLA VNR BARBED D6	1	PZ	VM2172A0	CLIP BLOCCAGGIO POMPA CON CIRCUITO	1	PZ																																												
Codice	Descrizione	Qtà	UM																																																														
VL1102A1	FILTRO IN LINEA DET. + VNR BARBED 6 MM	1	PZ																																																														
VL1128A0	VALVOLA VNR BARBED D6	1	PZ																																																														
VM2172A0	CLIP BLOCCAGGIO POMPA CON CIRCUITO	1	PZ																																																														
			KVL1101A	KIT IMPIANTO LAVAGGIO PLUS 1 GIRANTE EUR	<table border="1"> <thead> <tr> <th>Codice</th> <th>Descrizione</th> <th>Qtà</th> <th>UM</th> </tr> </thead> <tbody> <tr> <td>0H7323A0</td> <td>LAMIERA SUPPORTO LAVAGGIO PLUS</td> <td>1</td> <td>PZ</td> </tr> <tr> <td>0H7820A0</td> <td>SUPPORTO LAVAGGIO PLUS CON ELV STEAM</td> <td>1</td> <td>PZ</td> </tr> <tr> <td>EL1252A1</td> <td>ELETTROVALV OLA 1 VIA RID.VERDE JG D8-D10</td> <td>1</td> <td>PZ</td> </tr> <tr> <td>EL1424A0</td> <td>ELETTROVALV OLA H2O JG D8-PORTAGO MMA D6</td> <td>1</td> <td>PZ</td> </tr> <tr> <td>EL1436A0</td> <td>EV H2O JG D8-PORTAGO MMA D6 CHECK VALVE</td> <td>1</td> <td>PZ</td> </tr> <tr> <td>GN1526A0</td> <td>O-RING D.INT6.9 SP1.8</td> <td>1</td> <td>PZ</td> </tr> <tr> <td>RC1019A0</td> <td>FASCETTA ELASTICA D10 ZINCATA</td> <td>11</td> <td>PZ</td> </tr> <tr> <td>RC1130A0</td> <td>FASCETTA 130X2,6</td> <td>1</td> <td>PZ</td> </tr> <tr> <td>RC1242A0</td> <td>TERMINALE CHIUSO D10</td> <td>2</td> <td>PZ</td> </tr> <tr> <td>RC1310A0</td> <td>FASCETTA RICHCO 140X4 CON CLIP</td> <td>2</td> <td>PZ</td> </tr> <tr> <td>RC1356A0</td> <td>RACCORDO DRITTO FIL. FEMM 8X1/4 BSP</td> <td>1</td> <td>PZ</td> </tr> <tr> <td>RC1408A0</td> <td>FASCETTA BIFILARE A MOLLA D10.8 TUBO ZN</td> <td>6</td> <td>PZ</td> </tr> <tr> <td>TB1818A0</td> <td>TUBO 8X4.75 PE BLU</td> <td>0.220</td> <td>M</td> </tr> <tr> <td>TB2820A0</td> <td>TUBO EPDM 6X10</td> <td>1.240</td> <td>M</td> </tr> </tbody> </table>	Codice	Descrizione	Qtà	UM	0H7323A0	LAMIERA SUPPORTO LAVAGGIO PLUS	1	PZ	0H7820A0	SUPPORTO LAVAGGIO PLUS CON ELV STEAM	1	PZ	EL1252A1	ELETTROVALV OLA 1 VIA RID.VERDE JG D8-D10	1	PZ	EL1424A0	ELETTROVALV OLA H2O JG D8-PORTAGO MMA D6	1	PZ	EL1436A0	EV H2O JG D8-PORTAGO MMA D6 CHECK VALVE	1	PZ	GN1526A0	O-RING D.INT6.9 SP1.8	1	PZ	RC1019A0	FASCETTA ELASTICA D10 ZINCATA	11	PZ	RC1130A0	FASCETTA 130X2,6	1	PZ	RC1242A0	TERMINALE CHIUSO D10	2	PZ	RC1310A0	FASCETTA RICHCO 140X4 CON CLIP	2	PZ	RC1356A0	RACCORDO DRITTO FIL. FEMM 8X1/4 BSP	1	PZ	RC1408A0	FASCETTA BIFILARE A MOLLA D10.8 TUBO ZN	6	PZ	TB1818A0	TUBO 8X4.75 PE BLU	0.220	M	TB2820A0	TUBO EPDM 6X10	1.240	M
Codice	Descrizione	Qtà	UM																																																														
0H7323A0	LAMIERA SUPPORTO LAVAGGIO PLUS	1	PZ																																																														
0H7820A0	SUPPORTO LAVAGGIO PLUS CON ELV STEAM	1	PZ																																																														
EL1252A1	ELETTROVALV OLA 1 VIA RID.VERDE JG D8-D10	1	PZ																																																														
EL1424A0	ELETTROVALV OLA H2O JG D8-PORTAGO MMA D6	1	PZ																																																														
EL1436A0	EV H2O JG D8-PORTAGO MMA D6 CHECK VALVE	1	PZ																																																														
GN1526A0	O-RING D.INT6.9 SP1.8	1	PZ																																																														
RC1019A0	FASCETTA ELASTICA D10 ZINCATA	11	PZ																																																														
RC1130A0	FASCETTA 130X2,6	1	PZ																																																														
RC1242A0	TERMINALE CHIUSO D10	2	PZ																																																														
RC1310A0	FASCETTA RICHCO 140X4 CON CLIP	2	PZ																																																														
RC1356A0	RACCORDO DRITTO FIL. FEMM 8X1/4 BSP	1	PZ																																																														
RC1408A0	FASCETTA BIFILARE A MOLLA D10.8 TUBO ZN	6	PZ																																																														
TB1818A0	TUBO 8X4.75 PE BLU	0.220	M																																																														
TB2820A0	TUBO EPDM 6X10	1.240	M																																																														

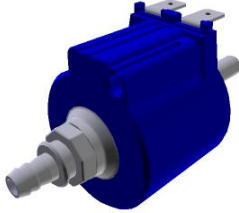

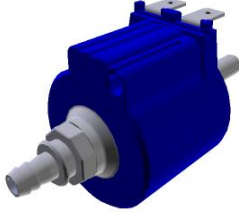
COMPONENTE			RICAMBIO																																																						
Codice	Descrizione	Immagine	Codice	Descrizione	Lista componenti																																																				
VL1019A	POMPA VIBRAZIONE		KVL1101A	KIT IMPIANTO LAVAGGIO PLUS 1 GIRANTE EUR	<table border="1"> <thead> <tr> <th>Codice</th> <th>Descrizione</th> <th>Qtà</th> <th>UM</th> </tr> </thead> <tbody> <tr> <td>VI1220A1</td> <td>VITE AUTOFILETTA NTE 4.2X11 TCS+ MARUTE</td> <td>2</td> <td>PZ</td> </tr> <tr> <td>VL1019A0</td> <td>POMPA VIBRAZIONE</td> <td>1</td> <td>PZ</td> </tr> <tr> <td>VL1064A0</td> <td>DISTRIBUTOR E USCITE CIRCUITO LAVAGGIO PL</td> <td>1</td> <td>PZ</td> </tr> <tr> <td>VL1065A1</td> <td>PRESSOSTAT O.N.O. 1/4 M CI</td> <td>1</td> <td>PZ</td> </tr> <tr> <td>VL1067A0</td> <td>DISTRIBUTOR E INGRESSI CIRCUITO LAVAGGIO</td> <td>1</td> <td>PZ</td> </tr> <tr> <td>VL1080A0</td> <td>FILTRO IN LINEA DETERGENTE</td> <td>1</td> <td>PZ</td> </tr> <tr> <td>VL1081A0</td> <td>VALVOLA NON RITORNO BARBED D6</td> <td>2</td> <td>PZ</td> </tr> <tr> <td>VL1083A0</td> <td>RACCORDO D10 - PORTAGOMM A BARBED D6</td> <td>1</td> <td>PZ</td> </tr> <tr> <td>VL1102A0</td> <td>FILTRO IN LINEA CON VNR BARBED 6 MM</td> <td>1</td> <td>PZ</td> </tr> <tr> <td>VL1102A1</td> <td>FILTRO IN LINEA DET. + VNR BARBED 6 MM</td> <td>1</td> <td>PZ</td> </tr> <tr> <td>VL1128A0</td> <td>VALVOLA VNR BARBED D6</td> <td>1</td> <td>PZ</td> </tr> <tr> <td>VM2172A0</td> <td>CLIP BLOCCAGGIO POMPA CON CIRCUITO</td> <td>1</td> <td>PZ</td> </tr> </tbody> </table>	Codice	Descrizione	Qtà	UM	VI1220A1	VITE AUTOFILETTA NTE 4.2X11 TCS+ MARUTE	2	PZ	VL1019A0	POMPA VIBRAZIONE	1	PZ	VL1064A0	DISTRIBUTOR E USCITE CIRCUITO LAVAGGIO PL	1	PZ	VL1065A1	PRESSOSTAT O.N.O. 1/4 M CI	1	PZ	VL1067A0	DISTRIBUTOR E INGRESSI CIRCUITO LAVAGGIO	1	PZ	VL1080A0	FILTRO IN LINEA DETERGENTE	1	PZ	VL1081A0	VALVOLA NON RITORNO BARBED D6	2	PZ	VL1083A0	RACCORDO D10 - PORTAGOMM A BARBED D6	1	PZ	VL1102A0	FILTRO IN LINEA CON VNR BARBED 6 MM	1	PZ	VL1102A1	FILTRO IN LINEA DET. + VNR BARBED 6 MM	1	PZ	VL1128A0	VALVOLA VNR BARBED D6	1	PZ	VM2172A0	CLIP BLOCCAGGIO POMPA CON CIRCUITO	1	PZ
Codice	Descrizione	Qtà	UM																																																						
VI1220A1	VITE AUTOFILETTA NTE 4.2X11 TCS+ MARUTE	2	PZ																																																						
VL1019A0	POMPA VIBRAZIONE	1	PZ																																																						
VL1064A0	DISTRIBUTOR E USCITE CIRCUITO LAVAGGIO PL	1	PZ																																																						
VL1065A1	PRESSOSTAT O.N.O. 1/4 M CI	1	PZ																																																						
VL1067A0	DISTRIBUTOR E INGRESSI CIRCUITO LAVAGGIO	1	PZ																																																						
VL1080A0	FILTRO IN LINEA DETERGENTE	1	PZ																																																						
VL1081A0	VALVOLA NON RITORNO BARBED D6	2	PZ																																																						
VL1083A0	RACCORDO D10 - PORTAGOMM A BARBED D6	1	PZ																																																						
VL1102A0	FILTRO IN LINEA CON VNR BARBED 6 MM	1	PZ																																																						
VL1102A1	FILTRO IN LINEA DET. + VNR BARBED 6 MM	1	PZ																																																						
VL1128A0	VALVOLA VNR BARBED D6	1	PZ																																																						
VM2172A0	CLIP BLOCCAGGIO POMPA CON CIRCUITO	1	PZ																																																						
			KVL1094A	KIT IMPIANTO LAVAGGIO 0311 EU	<table border="1"> <thead> <tr> <th>Codice</th> <th>Descrizione</th> <th>Qtà</th> <th>UM</th> </tr> </thead> <tbody> <tr> <td>0H7494A0</td> <td>LAMIERA SUPPORTO LAVAGGIO ONE-03</td> <td>1</td> <td>PZ</td> </tr> <tr> <td>0H7494B0</td> <td>LAMIERA SUPPORTO LAVAGGIO ONE-03</td> <td>1</td> <td>PZ</td> </tr> <tr> <td>EL1436A0</td> <td>EV H2O JG D8-PORTAGO MMA D6 CHECK VALVE</td> <td>1</td> <td>PZ</td> </tr> </tbody> </table>	Codice	Descrizione	Qtà	UM	0H7494A0	LAMIERA SUPPORTO LAVAGGIO ONE-03	1	PZ	0H7494B0	LAMIERA SUPPORTO LAVAGGIO ONE-03	1	PZ	EL1436A0	EV H2O JG D8-PORTAGO MMA D6 CHECK VALVE	1	PZ																																				
Codice	Descrizione	Qtà	UM																																																						
0H7494A0	LAMIERA SUPPORTO LAVAGGIO ONE-03	1	PZ																																																						
0H7494B0	LAMIERA SUPPORTO LAVAGGIO ONE-03	1	PZ																																																						
EL1436A0	EV H2O JG D8-PORTAGO MMA D6 CHECK VALVE	1	PZ																																																						

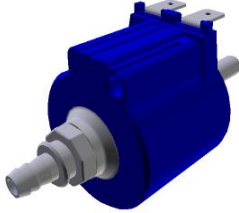

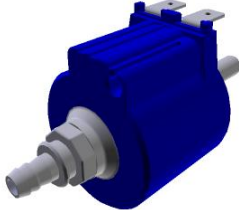
COMPONENTE			RICAMBIO																																																																										
Codice	Descrizione	Immagine	Codice	Descrizione	Lista componenti																																																																								
VL1019A	POMPA VIBRAZIONE		KVL1094A	KIT IMPIANTO LAVAGGIO 0311 EU	<table border="1"> <thead> <tr> <th>Codice</th> <th>Descrizione</th> <th>Qtà</th> <th>UM</th> </tr> </thead> <tbody> <tr> <td>GN1526A0</td> <td>O-RING D.INT6.9 SP1.8</td> <td>1</td> <td>PZ</td> </tr> <tr> <td>RC1006A0</td> <td>CURVA GUIDA TUBO PET D8</td> <td>2</td> <td>PZ</td> </tr> <tr> <td>RC1019A0</td> <td>FASCETTA ELASTICA D10 ZINCATA</td> <td>15</td> <td>PZ</td> </tr> <tr> <td>RC1242A0</td> <td>TERMINALE CHIUSO D10</td> <td>2</td> <td>PZ</td> </tr> <tr> <td>RC1408A0</td> <td>FASCETTA BIFILARE A MOLLA D10.8 TUBO ZN</td> <td>4</td> <td>PZ</td> </tr> <tr> <td>TB1818A0</td> <td>TUBO 8X4.75 PE BLU</td> <td>0.320</td> <td>M</td> </tr> <tr> <td>TB2820A0</td> <td>TUBO EPDM 6X10</td> <td>1.030</td> <td>M</td> </tr> <tr> <td>VI1220A1</td> <td>VITE AUTOFILETTA NTE 4.2X11 TCS+ MARUTE</td> <td>1</td> <td>PZ</td> </tr> <tr> <td>VL1019A0</td> <td>POMPA VIBRAZIONE</td> <td>1</td> <td>PZ</td> </tr> <tr> <td>VL1053B0</td> <td>DISTRIBUTOR E USCITA LAVAGGIO ON</td> <td>1</td> <td>PZ</td> </tr> <tr> <td>VL1054B0</td> <td>DISTRIBUTOR E INGRESSI LAVAGGIO ON</td> <td>1</td> <td>PZ</td> </tr> <tr> <td>VL1080A0</td> <td>FILTRO IN LINEA DETERGENTE</td> <td>1</td> <td>PZ</td> </tr> <tr> <td>VL1081A0</td> <td>VALVOLA NON RITORNO BARBED D6</td> <td>1</td> <td>PZ</td> </tr> <tr> <td>VL1102A0</td> <td>FILTRO IN LINEA CON VNR BARBED 6 MM</td> <td>1</td> <td>PZ</td> </tr> <tr> <td>VL1102A1</td> <td>FILTRO IN LINEA DET. + VNR BARBED 6 MM</td> <td>1</td> <td>PZ</td> </tr> <tr> <td>VL1128A0</td> <td>VALVOLA VNR BARBED D6</td> <td>1</td> <td>PZ</td> </tr> <tr> <td>VM2172A0</td> <td>CLIP BLOCCAGGIO POMPA CON CIRCUITO</td> <td>1</td> <td>PZ</td> </tr> </tbody> </table>	Codice	Descrizione	Qtà	UM	GN1526A0	O-RING D.INT6.9 SP1.8	1	PZ	RC1006A0	CURVA GUIDA TUBO PET D8	2	PZ	RC1019A0	FASCETTA ELASTICA D10 ZINCATA	15	PZ	RC1242A0	TERMINALE CHIUSO D10	2	PZ	RC1408A0	FASCETTA BIFILARE A MOLLA D10.8 TUBO ZN	4	PZ	TB1818A0	TUBO 8X4.75 PE BLU	0.320	M	TB2820A0	TUBO EPDM 6X10	1.030	M	VI1220A1	VITE AUTOFILETTA NTE 4.2X11 TCS+ MARUTE	1	PZ	VL1019A0	POMPA VIBRAZIONE	1	PZ	VL1053B0	DISTRIBUTOR E USCITA LAVAGGIO ON	1	PZ	VL1054B0	DISTRIBUTOR E INGRESSI LAVAGGIO ON	1	PZ	VL1080A0	FILTRO IN LINEA DETERGENTE	1	PZ	VL1081A0	VALVOLA NON RITORNO BARBED D6	1	PZ	VL1102A0	FILTRO IN LINEA CON VNR BARBED 6 MM	1	PZ	VL1102A1	FILTRO IN LINEA DET. + VNR BARBED 6 MM	1	PZ	VL1128A0	VALVOLA VNR BARBED D6	1	PZ	VM2172A0	CLIP BLOCCAGGIO POMPA CON CIRCUITO	1	PZ
Codice	Descrizione	Qtà	UM																																																																										
GN1526A0	O-RING D.INT6.9 SP1.8	1	PZ																																																																										
RC1006A0	CURVA GUIDA TUBO PET D8	2	PZ																																																																										
RC1019A0	FASCETTA ELASTICA D10 ZINCATA	15	PZ																																																																										
RC1242A0	TERMINALE CHIUSO D10	2	PZ																																																																										
RC1408A0	FASCETTA BIFILARE A MOLLA D10.8 TUBO ZN	4	PZ																																																																										
TB1818A0	TUBO 8X4.75 PE BLU	0.320	M																																																																										
TB2820A0	TUBO EPDM 6X10	1.030	M																																																																										
VI1220A1	VITE AUTOFILETTA NTE 4.2X11 TCS+ MARUTE	1	PZ																																																																										
VL1019A0	POMPA VIBRAZIONE	1	PZ																																																																										
VL1053B0	DISTRIBUTOR E USCITA LAVAGGIO ON	1	PZ																																																																										
VL1054B0	DISTRIBUTOR E INGRESSI LAVAGGIO ON	1	PZ																																																																										
VL1080A0	FILTRO IN LINEA DETERGENTE	1	PZ																																																																										
VL1081A0	VALVOLA NON RITORNO BARBED D6	1	PZ																																																																										
VL1102A0	FILTRO IN LINEA CON VNR BARBED 6 MM	1	PZ																																																																										
VL1102A1	FILTRO IN LINEA DET. + VNR BARBED 6 MM	1	PZ																																																																										
VL1128A0	VALVOLA VNR BARBED D6	1	PZ																																																																										
VM2172A0	CLIP BLOCCAGGIO POMPA CON CIRCUITO	1	PZ																																																																										

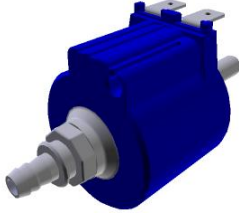

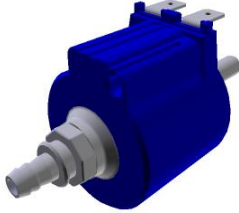
COMPONENTE			RICAMBIO																																																																																									
Codice	Descrizione	Immagine	Codice	Descrizione	Lista componenti																																																																																							
VL1019A	POMPA VIBRAZIONE		KVL1092A	KIT POMPA IMPIANTO LAVAGGIO PLUS 2GIR EU	<table border="1"> <thead> <tr> <th>Codice</th> <th>Descrizione</th> <th>Qtà</th> <th>UM</th> </tr> </thead> <tbody> <tr> <td>GN1526A0</td> <td>O-RING D.INT6.9 SP1.8</td> <td>1</td> <td>PZ</td> </tr> <tr> <td>RC1019A0</td> <td>FASCETTA ELASTICA D10 ZINCATA</td> <td>4</td> <td>PZ</td> </tr> <tr> <td>RC1130A0</td> <td>FASCETTA 130X2,6</td> <td>1</td> <td>PZ</td> </tr> <tr> <td>RC1242A0</td> <td>TERMINALE CHIUSO D10</td> <td>2</td> <td>PZ</td> </tr> <tr> <td>RC1408A0</td> <td>FASCETTA BIFILARE A MOLLA D10.8 TUBO ZN</td> <td>4</td> <td>PZ</td> </tr> <tr> <td>TB2820A0</td> <td>TUBO EPDM 6X10</td> <td>0.120</td> <td>M</td> </tr> <tr> <td>VI1220A1</td> <td>VITE AUTOFILETTA NTE 4.2X11 TCS+ MARUTE</td> <td>2</td> <td>PZ</td> </tr> <tr> <td>VL1019A0</td> <td>POMPA VIBRAZIONE</td> <td>1</td> <td>PZ</td> </tr> <tr> <td>VL1067A0</td> <td>DISTRIBUTOR E INGRESSI CIRCUITO LAVAGGIO</td> <td>1</td> <td>PZ</td> </tr> <tr> <td>VL1081A0</td> <td>VALVOLA NON RITORNO BARBED D6</td> <td>1</td> <td>PZ</td> </tr> <tr> <td>VL1092A0</td> <td>DISTRIBUTOR E USCITE LAVAGGIO PLUS DOPPIA</td> <td>1</td> <td>PZ</td> </tr> <tr> <td>VL1128A0</td> <td>VALVOLA VNR BARBED D6</td> <td>1</td> <td>PZ</td> </tr> <tr> <td>VM2172A0</td> <td>CLIP BLOCCAGGIO POMPA CON CIRCUITO</td> <td>1</td> <td>PZ</td> </tr> </tbody> </table>	Codice	Descrizione	Qtà	UM	GN1526A0	O-RING D.INT6.9 SP1.8	1	PZ	RC1019A0	FASCETTA ELASTICA D10 ZINCATA	4	PZ	RC1130A0	FASCETTA 130X2,6	1	PZ	RC1242A0	TERMINALE CHIUSO D10	2	PZ	RC1408A0	FASCETTA BIFILARE A MOLLA D10.8 TUBO ZN	4	PZ	TB2820A0	TUBO EPDM 6X10	0.120	M	VI1220A1	VITE AUTOFILETTA NTE 4.2X11 TCS+ MARUTE	2	PZ	VL1019A0	POMPA VIBRAZIONE	1	PZ	VL1067A0	DISTRIBUTOR E INGRESSI CIRCUITO LAVAGGIO	1	PZ	VL1081A0	VALVOLA NON RITORNO BARBED D6	1	PZ	VL1092A0	DISTRIBUTOR E USCITE LAVAGGIO PLUS DOPPIA	1	PZ	VL1128A0	VALVOLA VNR BARBED D6	1	PZ	VM2172A0	CLIP BLOCCAGGIO POMPA CON CIRCUITO	1	PZ	KVL1073A	KIT POMPA IMPIANTO LAVAGGIO PLUS 1GIR EU	<table border="1"> <thead> <tr> <th>Codice</th> <th>Descrizione</th> <th>Qtà</th> <th>UM</th> </tr> </thead> <tbody> <tr> <td>GN1526A0</td> <td>O-RING D.INT6.9 SP1.8</td> <td>1</td> <td>PZ</td> </tr> <tr> <td>RC1019A0</td> <td>FASCETTA ELASTICA D10 ZINCATA</td> <td>4</td> <td>PZ</td> </tr> <tr> <td>RC1130A0</td> <td>FASCETTA 130X2,6</td> <td>1</td> <td>PZ</td> </tr> <tr> <td>RC1242A0</td> <td>TERMINALE CHIUSO D10</td> <td>2</td> <td>PZ</td> </tr> <tr> <td>RC1408A0</td> <td>FASCETTA BIFILARE A MOLLA D10.8 TUBO ZN</td> <td>2</td> <td>PZ</td> </tr> <tr> <td>TB2820A0</td> <td>TUBO EPDM 6X10</td> <td>0.120</td> <td>M</td> </tr> </tbody> </table>	Codice	Descrizione	Qtà	UM	GN1526A0	O-RING D.INT6.9 SP1.8	1	PZ	RC1019A0	FASCETTA ELASTICA D10 ZINCATA	4	PZ	RC1130A0	FASCETTA 130X2,6	1	PZ	RC1242A0	TERMINALE CHIUSO D10	2	PZ	RC1408A0	FASCETTA BIFILARE A MOLLA D10.8 TUBO ZN	2	PZ	TB2820A0	TUBO EPDM 6X10	0.120	M
			Codice	Descrizione	Qtà	UM																																																																																						
GN1526A0	O-RING D.INT6.9 SP1.8	1	PZ																																																																																									
RC1019A0	FASCETTA ELASTICA D10 ZINCATA	4	PZ																																																																																									
RC1130A0	FASCETTA 130X2,6	1	PZ																																																																																									
RC1242A0	TERMINALE CHIUSO D10	2	PZ																																																																																									
RC1408A0	FASCETTA BIFILARE A MOLLA D10.8 TUBO ZN	4	PZ																																																																																									
TB2820A0	TUBO EPDM 6X10	0.120	M																																																																																									
VI1220A1	VITE AUTOFILETTA NTE 4.2X11 TCS+ MARUTE	2	PZ																																																																																									
VL1019A0	POMPA VIBRAZIONE	1	PZ																																																																																									
VL1067A0	DISTRIBUTOR E INGRESSI CIRCUITO LAVAGGIO	1	PZ																																																																																									
VL1081A0	VALVOLA NON RITORNO BARBED D6	1	PZ																																																																																									
VL1092A0	DISTRIBUTOR E USCITE LAVAGGIO PLUS DOPPIA	1	PZ																																																																																									
VL1128A0	VALVOLA VNR BARBED D6	1	PZ																																																																																									
VM2172A0	CLIP BLOCCAGGIO POMPA CON CIRCUITO	1	PZ																																																																																									
Codice	Descrizione	Qtà	UM																																																																																									
GN1526A0	O-RING D.INT6.9 SP1.8	1	PZ																																																																																									
RC1019A0	FASCETTA ELASTICA D10 ZINCATA	4	PZ																																																																																									
RC1130A0	FASCETTA 130X2,6	1	PZ																																																																																									
RC1242A0	TERMINALE CHIUSO D10	2	PZ																																																																																									
RC1408A0	FASCETTA BIFILARE A MOLLA D10.8 TUBO ZN	2	PZ																																																																																									
TB2820A0	TUBO EPDM 6X10	0.120	M																																																																																									



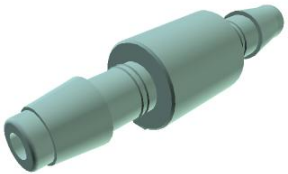

COMPONENTE			RICAMBIO																																																						
Codice	Descrizione	Immagine	Codice	Descrizione	Lista componenti																																																				
VL1019A	POMPA VIBRAZIONE		KVL1073A	KIT POMPA IMPIANTO LAVAGGIO PLUS 1GIR EU	<table border="1"> <thead> <tr> <th>Codice</th> <th>Descrizione</th> <th>Qtà</th> <th>UM</th> </tr> </thead> <tbody> <tr> <td>VL1019A0</td> <td>POMPA VIBRAZIONE</td> <td>1</td> <td>PZ</td> </tr> <tr> <td>VL1064A0</td> <td>DISTRIBUTOR E USCITE CIRCUITO LAVAGGIO PL</td> <td>1</td> <td>PZ</td> </tr> <tr> <td>VL1067A0</td> <td>DISTRIBUTOR E INGRESSI CIRCUITO LAVAGGIO</td> <td>1</td> <td>PZ</td> </tr> <tr> <td>VL1081A0</td> <td>VALVOLA NON RITORNO BARBED D6</td> <td>1</td> <td>PZ</td> </tr> <tr> <td>VL1128A0</td> <td>VALVOLA VNR BARBED D6</td> <td>1</td> <td>PZ</td> </tr> <tr> <td>VM2172A0</td> <td>CLIP BLOCCAGGIO POMPA CON CIRCUITO</td> <td>1</td> <td>PZ</td> </tr> </tbody> </table>	Codice	Descrizione	Qtà	UM	VL1019A0	POMPA VIBRAZIONE	1	PZ	VL1064A0	DISTRIBUTOR E USCITE CIRCUITO LAVAGGIO PL	1	PZ	VL1067A0	DISTRIBUTOR E INGRESSI CIRCUITO LAVAGGIO	1	PZ	VL1081A0	VALVOLA NON RITORNO BARBED D6	1	PZ	VL1128A0	VALVOLA VNR BARBED D6	1	PZ	VM2172A0	CLIP BLOCCAGGIO POMPA CON CIRCUITO	1	PZ																								
Codice	Descrizione	Qtà	UM																																																						
VL1019A0	POMPA VIBRAZIONE	1	PZ																																																						
VL1064A0	DISTRIBUTOR E USCITE CIRCUITO LAVAGGIO PL	1	PZ																																																						
VL1067A0	DISTRIBUTOR E INGRESSI CIRCUITO LAVAGGIO	1	PZ																																																						
VL1081A0	VALVOLA NON RITORNO BARBED D6	1	PZ																																																						
VL1128A0	VALVOLA VNR BARBED D6	1	PZ																																																						
VM2172A0	CLIP BLOCCAGGIO POMPA CON CIRCUITO	1	PZ																																																						
			KVL1072A	KIT POMPA IMPIANTO LAVAGGIO ONE	<table border="1"> <thead> <tr> <th>Codice</th> <th>Descrizione</th> <th>Qtà</th> <th>UM</th> </tr> </thead> <tbody> <tr> <td>GN1526A0</td> <td>O-RING D.INT6.9 SP1.8</td> <td>1</td> <td>PZ</td> </tr> <tr> <td>RC1019A0</td> <td>FASCETTA ELASTICA D10 ZINCATA</td> <td>3</td> <td>PZ</td> </tr> <tr> <td>RC1242A0</td> <td>TERMINALE CHIUSO D10</td> <td>2</td> <td>PZ</td> </tr> <tr> <td>RC1408A0</td> <td>FASCETTA BIFILARE A MOLLA D10.8 TUBO ZN</td> <td>2</td> <td>PZ</td> </tr> <tr> <td>TB2820A0</td> <td>TUBO EPDM 6X10</td> <td>0.120</td> <td>M</td> </tr> <tr> <td>VI1220A1</td> <td>VITE AUTOFILETTA NTE 4.2X11 TCS+ MARUTE</td> <td>1</td> <td>PZ</td> </tr> <tr> <td>VL1019A0</td> <td>POMPA VIBRAZIONE</td> <td>1</td> <td>PZ</td> </tr> <tr> <td>VL1053B0</td> <td>DISTRIBUTOR E USCITA LAVAGGIO ON</td> <td>1</td> <td>PZ</td> </tr> <tr> <td>VL1054B0</td> <td>DISTRIBUTOR E INGRESSI LAVAGGIO ON</td> <td>1</td> <td>PZ</td> </tr> <tr> <td>VL1081A0</td> <td>VALVOLA NON RITORNO BARBED D6</td> <td>2</td> <td>PZ</td> </tr> <tr> <td>VL1128A0</td> <td>VALVOLA VNR BARBED D6</td> <td>1</td> <td>PZ</td> </tr> <tr> <td>VM2172A0</td> <td>CLIP BLOCCAGGIO POMPA CON CIRCUITO</td> <td>1</td> <td>PZ</td> </tr> </tbody> </table>	Codice	Descrizione	Qtà	UM	GN1526A0	O-RING D.INT6.9 SP1.8	1	PZ	RC1019A0	FASCETTA ELASTICA D10 ZINCATA	3	PZ	RC1242A0	TERMINALE CHIUSO D10	2	PZ	RC1408A0	FASCETTA BIFILARE A MOLLA D10.8 TUBO ZN	2	PZ	TB2820A0	TUBO EPDM 6X10	0.120	M	VI1220A1	VITE AUTOFILETTA NTE 4.2X11 TCS+ MARUTE	1	PZ	VL1019A0	POMPA VIBRAZIONE	1	PZ	VL1053B0	DISTRIBUTOR E USCITA LAVAGGIO ON	1	PZ	VL1054B0	DISTRIBUTOR E INGRESSI LAVAGGIO ON	1	PZ	VL1081A0	VALVOLA NON RITORNO BARBED D6	2	PZ	VL1128A0	VALVOLA VNR BARBED D6	1	PZ	VM2172A0	CLIP BLOCCAGGIO POMPA CON CIRCUITO	1	PZ
Codice	Descrizione	Qtà	UM																																																						
GN1526A0	O-RING D.INT6.9 SP1.8	1	PZ																																																						
RC1019A0	FASCETTA ELASTICA D10 ZINCATA	3	PZ																																																						
RC1242A0	TERMINALE CHIUSO D10	2	PZ																																																						
RC1408A0	FASCETTA BIFILARE A MOLLA D10.8 TUBO ZN	2	PZ																																																						
TB2820A0	TUBO EPDM 6X10	0.120	M																																																						
VI1220A1	VITE AUTOFILETTA NTE 4.2X11 TCS+ MARUTE	1	PZ																																																						
VL1019A0	POMPA VIBRAZIONE	1	PZ																																																						
VL1053B0	DISTRIBUTOR E USCITA LAVAGGIO ON	1	PZ																																																						
VL1054B0	DISTRIBUTOR E INGRESSI LAVAGGIO ON	1	PZ																																																						
VL1081A0	VALVOLA NON RITORNO BARBED D6	2	PZ																																																						
VL1128A0	VALVOLA VNR BARBED D6	1	PZ																																																						
VM2172A0	CLIP BLOCCAGGIO POMPA CON CIRCUITO	1	PZ																																																						

COMPONENTE			RICAMBIO																																																																														
Codice	Descrizione	Immagine	Codice	Descrizione	Lista componenti																																																																												
VL1019A	POMPA VIBRAZIONE		KVL0001A	KIT IMPIANTO LAVAGGIO LM TOP	<table border="1"> <thead> <tr> <th>Codice</th> <th>Descrizione</th> <th>Qtà</th> <th>UM</th> </tr> </thead> <tbody> <tr> <td>0H1226A0</td> <td>LAMIERA CIRCUITO LAVAGGIO LINEMISS</td> <td>1</td> <td>PZ</td> </tr> <tr> <td>0H1226B0</td> <td>LAMIERA CIRCUITO LAVAGGIO LINEMISS</td> <td>1</td> <td>PZ</td> </tr> <tr> <td>EL1180A0</td> <td>RACCORDO NON RITORNO Ø8 Ø8 FEMMIN</td> <td>1</td> <td>PZ</td> </tr> <tr> <td>GN1312A0</td> <td>PASSACAVO GOMMA DE=26 DI=15 SP=10</td> <td>1</td> <td>PZ</td> </tr> <tr> <td>GN1526A0</td> <td>O-RING D.INT6.9 SP1.8</td> <td>1</td> <td>PZ</td> </tr> <tr> <td>RC1008A0</td> <td>FASCETTA ELASTICA D9 ZINCATA</td> <td>3</td> <td>PZ</td> </tr> <tr> <td>RC1019A0</td> <td>FASCETTA ELASTICA D10 ZINCATA</td> <td>3</td> <td>PZ</td> </tr> <tr> <td>RC1242A0</td> <td>TERMINALE CHIUSO D10</td> <td>2</td> <td>PZ</td> </tr> <tr> <td>RC1381A0</td> <td>BIFILARI STRINGI TUBO D10.7 ZINCAT</td> <td>3</td> <td>PZ</td> </tr> <tr> <td>RC1408A0</td> <td>FASCETTA BIFILARE A MOLLA D10.8 TUBO ZN</td> <td>2</td> <td>PZ</td> </tr> <tr> <td>TB2343A0</td> <td>TUBO PVC TRASPARENT E 9X6</td> <td>2.630</td> <td>M</td> </tr> <tr> <td>TB2820A0</td> <td>TUBO EPDM 6X10</td> <td>0.990</td> <td>M</td> </tr> <tr> <td>VH1220A1</td> <td>VITE AUTOFILETTA NTE 4.2X11 TCS+ MARUTE</td> <td>1</td> <td>PZ</td> </tr> <tr> <td>VL1019A0</td> <td>POMPA VIBRAZIONE</td> <td>1</td> <td>PZ</td> </tr> <tr> <td>VL1041C0</td> <td>TAPPO DETERGENTE FORATO Ø12</td> <td>1</td> <td>PZ</td> </tr> <tr> <td>VL1047A1</td> <td>PORTAGOMM A D6 CODOLO D8</td> <td>1</td> <td>PZ</td> </tr> <tr> <td>VL1053A1</td> <td>CIRCUITO LAVAGGIO POMPA USCIT</td> <td>1</td> <td>PZ</td> </tr> <tr> <td>VL1053B0</td> <td>DISTRIBUTOR E USCITA LAVAGGIO ON</td> <td>1</td> <td>PZ</td> </tr> </tbody> </table>	Codice	Descrizione	Qtà	UM	0H1226A0	LAMIERA CIRCUITO LAVAGGIO LINEMISS	1	PZ	0H1226B0	LAMIERA CIRCUITO LAVAGGIO LINEMISS	1	PZ	EL1180A0	RACCORDO NON RITORNO Ø8 Ø8 FEMMIN	1	PZ	GN1312A0	PASSACAVO GOMMA DE=26 DI=15 SP=10	1	PZ	GN1526A0	O-RING D.INT6.9 SP1.8	1	PZ	RC1008A0	FASCETTA ELASTICA D9 ZINCATA	3	PZ	RC1019A0	FASCETTA ELASTICA D10 ZINCATA	3	PZ	RC1242A0	TERMINALE CHIUSO D10	2	PZ	RC1381A0	BIFILARI STRINGI TUBO D10.7 ZINCAT	3	PZ	RC1408A0	FASCETTA BIFILARE A MOLLA D10.8 TUBO ZN	2	PZ	TB2343A0	TUBO PVC TRASPARENT E 9X6	2.630	M	TB2820A0	TUBO EPDM 6X10	0.990	M	VH1220A1	VITE AUTOFILETTA NTE 4.2X11 TCS+ MARUTE	1	PZ	VL1019A0	POMPA VIBRAZIONE	1	PZ	VL1041C0	TAPPO DETERGENTE FORATO Ø12	1	PZ	VL1047A1	PORTAGOMM A D6 CODOLO D8	1	PZ	VL1053A1	CIRCUITO LAVAGGIO POMPA USCIT	1	PZ	VL1053B0	DISTRIBUTOR E USCITA LAVAGGIO ON	1	PZ
Codice	Descrizione	Qtà	UM																																																																														
0H1226A0	LAMIERA CIRCUITO LAVAGGIO LINEMISS	1	PZ																																																																														
0H1226B0	LAMIERA CIRCUITO LAVAGGIO LINEMISS	1	PZ																																																																														
EL1180A0	RACCORDO NON RITORNO Ø8 Ø8 FEMMIN	1	PZ																																																																														
GN1312A0	PASSACAVO GOMMA DE=26 DI=15 SP=10	1	PZ																																																																														
GN1526A0	O-RING D.INT6.9 SP1.8	1	PZ																																																																														
RC1008A0	FASCETTA ELASTICA D9 ZINCATA	3	PZ																																																																														
RC1019A0	FASCETTA ELASTICA D10 ZINCATA	3	PZ																																																																														
RC1242A0	TERMINALE CHIUSO D10	2	PZ																																																																														
RC1381A0	BIFILARI STRINGI TUBO D10.7 ZINCAT	3	PZ																																																																														
RC1408A0	FASCETTA BIFILARE A MOLLA D10.8 TUBO ZN	2	PZ																																																																														
TB2343A0	TUBO PVC TRASPARENT E 9X6	2.630	M																																																																														
TB2820A0	TUBO EPDM 6X10	0.990	M																																																																														
VH1220A1	VITE AUTOFILETTA NTE 4.2X11 TCS+ MARUTE	1	PZ																																																																														
VL1019A0	POMPA VIBRAZIONE	1	PZ																																																																														
VL1041C0	TAPPO DETERGENTE FORATO Ø12	1	PZ																																																																														
VL1047A1	PORTAGOMM A D6 CODOLO D8	1	PZ																																																																														
VL1053A1	CIRCUITO LAVAGGIO POMPA USCIT	1	PZ																																																																														
VL1053B0	DISTRIBUTOR E USCITA LAVAGGIO ON	1	PZ																																																																														



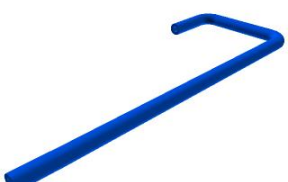

COMPONENTE			RICAMBIO																																										
Codice	Descrizione	Immagine	Codice	Descrizione	Lista componenti																																								
VL1019A	POMPA VIBRAZIONE		KVL0001A	KIT IMPIANTO LAVAGGIO LM TOP	<table border="1"> <thead> <tr> <th>Codice</th> <th>Descrizione</th> <th>Qtà</th> <th>UM</th> </tr> </thead> <tbody> <tr> <td>VL1054A1</td> <td>CIRCUITO LAVAGGIO POMPA INGRESSI</td> <td>1</td> <td>PZ</td> </tr> <tr> <td>VL1054B0</td> <td>DISTRIBUTOR E INGRESSI LAVAGGIO ON</td> <td>1</td> <td>PZ</td> </tr> <tr> <td>VL1061A0</td> <td>FILTRO RETINATO+AF FONDANTE+V NR XFT200</td> <td>1</td> <td>PZ</td> </tr> <tr> <td>VL1081A0</td> <td>VALVOLA NON RITORNO BARBED D6</td> <td>1</td> <td>PZ</td> </tr> <tr> <td>VL1128A0</td> <td>VALVOLA VNR BARBED D6</td> <td>2</td> <td>PZ</td> </tr> <tr> <td>VM1066A0</td> <td>CLIP A SELLA PASSAGGIO CAVI</td> <td>3</td> <td>PZ</td> </tr> <tr> <td>VM1088A0</td> <td>FASCETTA A SCATTO D7.9-D9.2 PP</td> <td>1</td> <td>PZ</td> </tr> <tr> <td>VM1605A0</td> <td>CLIP TWIST LOCK DIAM. 10,2-12,7 MM</td> <td>1</td> <td>PZ</td> </tr> <tr> <td>VM2172A0</td> <td>CLIP BLOCCAGGIO POMPA CON CIRCUITO</td> <td>1</td> <td>PZ</td> </tr> </tbody> </table>	Codice	Descrizione	Qtà	UM	VL1054A1	CIRCUITO LAVAGGIO POMPA INGRESSI	1	PZ	VL1054B0	DISTRIBUTOR E INGRESSI LAVAGGIO ON	1	PZ	VL1061A0	FILTRO RETINATO+AF FONDANTE+V NR XFT200	1	PZ	VL1081A0	VALVOLA NON RITORNO BARBED D6	1	PZ	VL1128A0	VALVOLA VNR BARBED D6	2	PZ	VM1066A0	CLIP A SELLA PASSAGGIO CAVI	3	PZ	VM1088A0	FASCETTA A SCATTO D7.9-D9.2 PP	1	PZ	VM1605A0	CLIP TWIST LOCK DIAM. 10,2-12,7 MM	1	PZ	VM2172A0	CLIP BLOCCAGGIO POMPA CON CIRCUITO	1	PZ
Codice	Descrizione	Qtà	UM																																										
VL1054A1	CIRCUITO LAVAGGIO POMPA INGRESSI	1	PZ																																										
VL1054B0	DISTRIBUTOR E INGRESSI LAVAGGIO ON	1	PZ																																										
VL1061A0	FILTRO RETINATO+AF FONDANTE+V NR XFT200	1	PZ																																										
VL1081A0	VALVOLA NON RITORNO BARBED D6	1	PZ																																										
VL1128A0	VALVOLA VNR BARBED D6	2	PZ																																										
VM1066A0	CLIP A SELLA PASSAGGIO CAVI	3	PZ																																										
VM1088A0	FASCETTA A SCATTO D7.9-D9.2 PP	1	PZ																																										
VM1605A0	CLIP TWIST LOCK DIAM. 10,2-12,7 MM	1	PZ																																										
VM2172A0	CLIP BLOCCAGGIO POMPA CON CIRCUITO	1	PZ																																										
VM2172A	CLIP BLOCCAGGIO POMPA CON CIRCUITO		VM2172A0	CLIP BLOCCAGGIO POMPA CON CIRCUITO																																									
RC1019A	FASCETTA ELASTICA D10 ZINCATA		KRC1019A	KIT 15 PZ. FASCETTA ELASTICA D10 ZINCATA	<table border="1"> <thead> <tr> <th>Codice</th> <th>Descrizione</th> <th>Qtà</th> <th>UM</th> </tr> </thead> <tbody> <tr> <td>RC1019A0</td> <td>FASCETTA ELASTICA D10 ZINCATA</td> <td>15</td> <td>PZ</td> </tr> </tbody> </table>	Codice	Descrizione	Qtà	UM	RC1019A0	FASCETTA ELASTICA D10 ZINCATA	15	PZ																																
Codice	Descrizione	Qtà	UM																																										
RC1019A0	FASCETTA ELASTICA D10 ZINCATA	15	PZ																																										

COMPONENTE			RICAMBIO																			
Codice	Descrizione	Immagine	Codice	Descrizione	Lista componenti																	
VL1081A	VALVOLA NON RITORNO BARBED D		KVL1128A	KIT VALVOLA VNR BARBED D6	<table border="1"> <thead> <tr> <th>Codice</th> <th>Descrizione</th> <th>Qtà</th> <th>UM</th> </tr> </thead> <tbody> <tr> <td>RC1019A0</td> <td>FASCETTA ELASTICA D10 ZINCATA</td> <td>2</td> <td>PZ</td> </tr> <tr> <td>TB2820A0</td> <td>TUBO EPDM 6X10</td> <td>0.080</td> <td>M</td> </tr> <tr> <td>VL1128A0</td> <td>VALVOLA VNR BARBED D6</td> <td>1</td> <td>PZ</td> </tr> </tbody> </table>	Codice	Descrizione	Qtà	UM	RC1019A0	FASCETTA ELASTICA D10 ZINCATA	2	PZ	TB2820A0	TUBO EPDM 6X10	0.080	M	VL1128A0	VALVOLA VNR BARBED D6	1	PZ	
			Codice	Descrizione	Qtà	UM																
			RC1019A0	FASCETTA ELASTICA D10 ZINCATA	2	PZ																
TB2820A0	TUBO EPDM 6X10	0.080	M																			
VL1128A0	VALVOLA VNR BARBED D6	1	PZ																			
KVL1102A	KIT FILTRO IN LINEA DETERGENTE CON VNR	<table border="1"> <thead> <tr> <th>Codice</th> <th>Descrizione</th> <th>Qtà</th> <th>UM</th> </tr> </thead> <tbody> <tr> <td>RC1019A0</td> <td>FASCETTA ELASTICA D10 ZINCATA</td> <td>3</td> <td>PZ</td> </tr> <tr> <td>TB2820A0</td> <td>TUBO EPDM 6X10</td> <td>0.110</td> <td>M</td> </tr> <tr> <td>VL1102A0</td> <td>FILTRO IN LINEA CON VNR BARBED 6 MM</td> <td>1</td> <td>PZ</td> </tr> <tr> <td>VL1102A1</td> <td>FILTRO IN LINEA DET. + VNR BARBED 6 MM</td> <td>1</td> <td>PZ</td> </tr> </tbody> </table>	Codice	Descrizione	Qtà	UM	RC1019A0	FASCETTA ELASTICA D10 ZINCATA	3	PZ	TB2820A0	TUBO EPDM 6X10	0.110	M	VL1102A0	FILTRO IN LINEA CON VNR BARBED 6 MM	1	PZ	VL1102A1	FILTRO IN LINEA DET. + VNR BARBED 6 MM	1	PZ
Codice	Descrizione	Qtà	UM																			
RC1019A0	FASCETTA ELASTICA D10 ZINCATA	3	PZ																			
TB2820A0	TUBO EPDM 6X10	0.110	M																			
VL1102A0	FILTRO IN LINEA CON VNR BARBED 6 MM	1	PZ																			
VL1102A1	FILTRO IN LINEA DET. + VNR BARBED 6 MM	1	PZ																			
KVL1081A	KIT 2 PZ VALVOLA NON RITORNO BARBED D6	<table border="1"> <thead> <tr> <th>Codice</th> <th>Descrizione</th> <th>Qtà</th> <th>UM</th> </tr> </thead> <tbody> <tr> <td>TB2820A0</td> <td>TUBO EPDM 6X10</td> <td>0.240</td> <td>M</td> </tr> <tr> <td>VL1081A0</td> <td>VALVOLA NON RITORNO BARBED D6</td> <td>3</td> <td>PZ</td> </tr> </tbody> </table>	Codice	Descrizione	Qtà	UM	TB2820A0	TUBO EPDM 6X10	0.240	M	VL1081A0	VALVOLA NON RITORNO BARBED D6	3	PZ								
Codice	Descrizione	Qtà	UM																			
TB2820A0	TUBO EPDM 6X10	0.240	M																			
VL1081A0	VALVOLA NON RITORNO BARBED D6	3	PZ																			
RC1242A	TERMINALE CHIUSO D10		KRC1242A	KIT 20 PZ.TERMINALE CHIUSO 110	<table border="1"> <thead> <tr> <th>Codice</th> <th>Descrizione</th> <th>Qtà</th> <th>UM</th> </tr> </thead> <tbody> <tr> <td>RC1242A0</td> <td>TERMINALE CHIUSO D10</td> <td>20</td> <td>PZ</td> </tr> </tbody> </table>	Codice	Descrizione	Qtà	UM	RC1242A0	TERMINALE CHIUSO D10	20	PZ									
Codice	Descrizione	Qtà	UM																			
RC1242A0	TERMINALE CHIUSO D10	20	PZ																			
VL1054B	DISTRIBUTORE INGRESSI LAVAGGIO ONE		KVL1054B	KIT DISTRIBUTORE INGRESSI LAVAGGIO ONE	<table border="1"> <thead> <tr> <th>Codice</th> <th>Descrizione</th> <th>Qtà</th> <th>UM</th> </tr> </thead> <tbody> <tr> <td>VL1054B0</td> <td>DISTRIBUTORE INGRESSI LAVAGGIO ONE</td> <td>1</td> <td>PZ</td> </tr> </tbody> </table>	Codice	Descrizione	Qtà	UM	VL1054B0	DISTRIBUTORE INGRESSI LAVAGGIO ONE	1	PZ									
Codice	Descrizione	Qtà	UM																			
VL1054B0	DISTRIBUTORE INGRESSI LAVAGGIO ONE	1	PZ																			

COMPONENTE			RICAMBIO																																																						
Codice	Descrizione	Immagine	Codice	Descrizione	Lista componenti																																																				
VL1053B	DISTRIBUTORE USCITA LAVAGGIO ONE		KVL1072A	KIT POMPA IMPIANTO LAVAGGIO ONE	<table border="1"> <thead> <tr> <th>Codice</th> <th>Descrizione</th> <th>Qtà</th> <th>UM</th> </tr> </thead> <tbody> <tr> <td>GN1526A0</td> <td>O-RING D.INT6.9 SP1.8</td> <td>1</td> <td>PZ</td> </tr> <tr> <td>RC1019A0</td> <td>FASCETTA ELASTICA D10 ZINCATA</td> <td>3</td> <td>PZ</td> </tr> <tr> <td>RC1242A0</td> <td>TERMINALE CHIUSO D10</td> <td>2</td> <td>PZ</td> </tr> <tr> <td>RC1408A0</td> <td>FASCETTA BIFILARE A MOLLA D10.8 TUBO ZN</td> <td>2</td> <td>PZ</td> </tr> <tr> <td>TB2820A0</td> <td>TUBO EPDM 6X10</td> <td>0.120</td> <td>M</td> </tr> <tr> <td>VI1220A1</td> <td>VITE AUTOFILETTA NTE 4.2X11 TCS+ MARUTE</td> <td>1</td> <td>PZ</td> </tr> <tr> <td>VL1019A0</td> <td>POMPA VIBRAZIONE</td> <td>1</td> <td>PZ</td> </tr> <tr> <td>VL1053B0</td> <td>DISTRIBUTORE USCITA LAVAGGIO ON</td> <td>1</td> <td>PZ</td> </tr> <tr> <td>VL1054B0</td> <td>DISTRIBUTORE INGRESSI LAVAGGIO ON</td> <td>1</td> <td>PZ</td> </tr> <tr> <td>VL1081A0</td> <td>VALVOLA NON RITORNO BARBED D6</td> <td>2</td> <td>PZ</td> </tr> <tr> <td>VL1128A0</td> <td>VALVOLA VNR BARBED D6</td> <td>1</td> <td>PZ</td> </tr> <tr> <td>VM2172A0</td> <td>CLIP BLOCCAGGIO POMPA CON CIRCUITO</td> <td>1</td> <td>PZ</td> </tr> </tbody> </table>	Codice	Descrizione	Qtà	UM	GN1526A0	O-RING D.INT6.9 SP1.8	1	PZ	RC1019A0	FASCETTA ELASTICA D10 ZINCATA	3	PZ	RC1242A0	TERMINALE CHIUSO D10	2	PZ	RC1408A0	FASCETTA BIFILARE A MOLLA D10.8 TUBO ZN	2	PZ	TB2820A0	TUBO EPDM 6X10	0.120	M	VI1220A1	VITE AUTOFILETTA NTE 4.2X11 TCS+ MARUTE	1	PZ	VL1019A0	POMPA VIBRAZIONE	1	PZ	VL1053B0	DISTRIBUTORE USCITA LAVAGGIO ON	1	PZ	VL1054B0	DISTRIBUTORE INGRESSI LAVAGGIO ON	1	PZ	VL1081A0	VALVOLA NON RITORNO BARBED D6	2	PZ	VL1128A0	VALVOLA VNR BARBED D6	1	PZ	VM2172A0	CLIP BLOCCAGGIO POMPA CON CIRCUITO	1	PZ
Codice	Descrizione	Qtà	UM																																																						
GN1526A0	O-RING D.INT6.9 SP1.8	1	PZ																																																						
RC1019A0	FASCETTA ELASTICA D10 ZINCATA	3	PZ																																																						
RC1242A0	TERMINALE CHIUSO D10	2	PZ																																																						
RC1408A0	FASCETTA BIFILARE A MOLLA D10.8 TUBO ZN	2	PZ																																																						
TB2820A0	TUBO EPDM 6X10	0.120	M																																																						
VI1220A1	VITE AUTOFILETTA NTE 4.2X11 TCS+ MARUTE	1	PZ																																																						
VL1019A0	POMPA VIBRAZIONE	1	PZ																																																						
VL1053B0	DISTRIBUTORE USCITA LAVAGGIO ON	1	PZ																																																						
VL1054B0	DISTRIBUTORE INGRESSI LAVAGGIO ON	1	PZ																																																						
VL1081A0	VALVOLA NON RITORNO BARBED D6	2	PZ																																																						
VL1128A0	VALVOLA VNR BARBED D6	1	PZ																																																						
VM2172A0	CLIP BLOCCAGGIO POMPA CON CIRCUITO	1	PZ																																																						
RC1408A	FASCETTA BIFILARE A MOLLA D10.8 TUBO ZN		KRC1408A	KIT FASCETTA BIFILARE A MOLLA D10.8 4PZ	<table border="1"> <thead> <tr> <th>Codice</th> <th>Descrizione</th> <th>Qtà</th> <th>UM</th> </tr> </thead> <tbody> <tr> <td>RC1408A0</td> <td>FASCETTA BIFILARE A MOLLA D10.8 TUBO ZN</td> <td>4</td> <td>PZ</td> </tr> </tbody> </table>	Codice	Descrizione	Qtà	UM	RC1408A0	FASCETTA BIFILARE A MOLLA D10.8 TUBO ZN	4	PZ																																												
Codice	Descrizione	Qtà	UM																																																						
RC1408A0	FASCETTA BIFILARE A MOLLA D10.8 TUBO ZN	4	PZ																																																						
EL1436A	EV H2O JG D8-PORTAGOMMA D6 CHECK VALVE		KEL1436A	KIT EV H2O JG D8-PORTAGOMMA D6 VNR	<table border="1"> <thead> <tr> <th>Codice</th> <th>Descrizione</th> <th>Qtà</th> <th>UM</th> </tr> </thead> <tbody> <tr> <td>EL1436A0</td> <td>EV H2O JG D8-PORTAGO MMA D6 CHECK VALVE</td> <td>1</td> <td>PZ</td> </tr> </tbody> </table>	Codice	Descrizione	Qtà	UM	EL1436A0	EV H2O JG D8-PORTAGO MMA D6 CHECK VALVE	1	PZ																																												
Codice	Descrizione	Qtà	UM																																																						
EL1436A0	EV H2O JG D8-PORTAGO MMA D6 CHECK VALVE	1	PZ																																																						

COMPONENTE			RICAMBIO																						
Codice	Descrizione	Immagine	Codice	Descrizione	Lista componenti																				
TB3009B	TB3132A-TUBO INGRESSO LAVAGGIO ONE		KTB1349A	KIT TB1818A - TUBO 8X4,75 PE BLU L=30	<table border="1"> <thead> <tr> <th>Codice</th> <th>Descrizione</th> <th>Qtà</th> <th>UM</th> </tr> </thead> <tbody> <tr> <td>TB1818A0</td> <td>TUBO 8X4.75 PE BLU</td> <td>30</td> <td>M</td> </tr> </tbody> </table>	Codice	Descrizione	Qtà	UM	TB1818A0	TUBO 8X4.75 PE BLU	30	M												
Codice	Descrizione	Qtà	UM																						
TB1818A0	TUBO 8X4.75 PE BLU	30	M																						
0H7819A	SUPPORTO LAVAGGIO ONE CON ELV STEAM		0H7819A0	SUPPORTO LAVAGGIO ONE CON ELV STEAM																					
VL1102A	FILTRO IN LINEA DET. + VNR BARBED 6 MM		KVL1102A	KIT FILTRO IN LINEA DETERGENTE CON VNR	<table border="1"> <thead> <tr> <th>Codice</th> <th>Descrizione</th> <th>Qtà</th> <th>UM</th> </tr> </thead> <tbody> <tr> <td>RC1019A0</td> <td>FASCETTA ELASTICA D10 ZINCATA</td> <td>3</td> <td>PZ</td> </tr> <tr> <td>TB2820A0</td> <td>TUBO EPDM 6X10</td> <td>0.110</td> <td>M</td> </tr> <tr> <td>VL1102A0</td> <td>FILTRO IN LINEA CON VNR BARBED 6 MM</td> <td>1</td> <td>PZ</td> </tr> <tr> <td>VL1102A1</td> <td>FILTRO IN LINEA DET. + VNR BARBED 6 MM</td> <td>1</td> <td>PZ</td> </tr> </tbody> </table>	Codice	Descrizione	Qtà	UM	RC1019A0	FASCETTA ELASTICA D10 ZINCATA	3	PZ	TB2820A0	TUBO EPDM 6X10	0.110	M	VL1102A0	FILTRO IN LINEA CON VNR BARBED 6 MM	1	PZ	VL1102A1	FILTRO IN LINEA DET. + VNR BARBED 6 MM	1	PZ
Codice	Descrizione	Qtà	UM																						
RC1019A0	FASCETTA ELASTICA D10 ZINCATA	3	PZ																						
TB2820A0	TUBO EPDM 6X10	0.110	M																						
VL1102A0	FILTRO IN LINEA CON VNR BARBED 6 MM	1	PZ																						
VL1102A1	FILTRO IN LINEA DET. + VNR BARBED 6 MM	1	PZ																						
TB3256A			TB3256A0																						
0E1352B	FONDO ESTERNO XEVC-2011-E		0E1352B0	FONDO ESTERNO XEVC-2011-E																					

COMPONENTE			RICAMBIO																										
Codice	Descrizione	Immagine	Codice	Descrizione	Lista componenti																								
TR1136A	TERMOSTATO SIC. UNIP. 330°C		KTR1136A	KIT TERMOSTATO SICUREZZA 330°C	<table border="1"> <thead> <tr> <th>Codice</th> <th>Descrizione</th> <th>Qtà</th> <th>UM</th> </tr> </thead> <tbody> <tr> <td>0H7030A0</td> <td>COPERCHIO INGRESSO BULBO</td> <td>1</td> <td>PZ</td> </tr> <tr> <td>GN1531A0</td> <td>GUARNIZIONE TENUTA INGRESSO BULBO</td> <td>1</td> <td>PZ</td> </tr> <tr> <td>SL1045A0</td> <td>SILICONE ANTRACITE S53 80 ML</td> <td>1</td> <td>PZ</td> </tr> <tr> <td>TR1136A0</td> <td>TERMOSTATO SIC. UNIP. 330°C</td> <td>1</td> <td>PZ</td> </tr> <tr> <td>VI1220A1</td> <td>VITE AUTOFILETTA NTE 4.2X11 TCS+ MARUTE</td> <td>3</td> <td>PZ</td> </tr> </tbody> </table>	Codice	Descrizione	Qtà	UM	0H7030A0	COPERCHIO INGRESSO BULBO	1	PZ	GN1531A0	GUARNIZIONE TENUTA INGRESSO BULBO	1	PZ	SL1045A0	SILICONE ANTRACITE S53 80 ML	1	PZ	TR1136A0	TERMOSTATO SIC. UNIP. 330°C	1	PZ	VI1220A1	VITE AUTOFILETTA NTE 4.2X11 TCS+ MARUTE	3	PZ
Codice	Descrizione	Qtà	UM																										
0H7030A0	COPERCHIO INGRESSO BULBO	1	PZ																										
GN1531A0	GUARNIZIONE TENUTA INGRESSO BULBO	1	PZ																										
SL1045A0	SILICONE ANTRACITE S53 80 ML	1	PZ																										
TR1136A0	TERMOSTATO SIC. UNIP. 330°C	1	PZ																										
VI1220A1	VITE AUTOFILETTA NTE 4.2X11 TCS+ MARUTE	3	PZ																										
VM2249A	ANGOLO FACCIATA MUFFOLA PPS		KVM2249A	KIT ANGOLO FACCIATA MUFFOL	<table border="1"> <thead> <tr> <th>Codice</th> <th>Descrizione</th> <th>Qtà</th> <th>UM</th> </tr> </thead> <tbody> <tr> <td>VM2249A0</td> <td>ANGOLO FACCIATA MUFFOLA PPS</td> <td>1</td> <td>PZ</td> </tr> </tbody> </table>	Codice	Descrizione	Qtà	UM	VM2249A0	ANGOLO FACCIATA MUFFOLA PPS	1	PZ																
Codice	Descrizione	Qtà	UM																										
VM2249A0	ANGOLO FACCIATA MUFFOLA PPS	1	PZ																										
VM1810A	TAPPO TENUTA ACQUA DX		VM1810A0	TAPPO TENUTA ACQUA DX																									
VM1811A	TAPPO TENUTA ACQUA SX		VM1811A0	TAPPO TENUTA ACQUA SX																									

COMPONENTE			RICAMBIO																										
Codice	Descrizione	Immagine	Codice	Descrizione	Lista componenti																								
VM2281A	PIASTRINA COPRI FORI		KVM2281A	KIT PIASTRINA COPRI FORI VM2281A0	<table border="1"> <thead> <tr> <th>Codice</th> <th>Descrizione</th> <th>Qtà</th> <th>UM</th> </tr> </thead> <tbody> <tr> <td>VM2281A0</td> <td>PIASTRINA COPRI FORI</td> <td>1</td> <td>PZ</td> </tr> </tbody> </table>	Codice	Descrizione	Qtà	UM	VM2281A0	PIASTRINA COPRI FORI	1	PZ																
Codice	Descrizione	Qtà	UM																										
VM2281A0	PIASTRINA COPRI FORI	1	PZ																										
VL1026A	CURVA PER TUBO DI SCARICO		KVL1026A	KIT CURVA PER TUBO DI SCARICO	<table border="1"> <thead> <tr> <th>Codice</th> <th>Descrizione</th> <th>Qtà</th> <th>UM</th> </tr> </thead> <tbody> <tr> <td>GN1400A0</td> <td>GUARNIZIONE SIFONE</td> <td>1</td> <td>PZ</td> </tr> <tr> <td>VL1026A0</td> <td>CURVA PER TUBO DI SCARICO</td> <td>1</td> <td>PZ</td> </tr> <tr> <td>VM2039A0</td> <td>ANELLO FISSAGGIO CURVA DI SCARICO</td> <td>1</td> <td>PZ</td> </tr> </tbody> </table>	Codice	Descrizione	Qtà	UM	GN1400A0	GUARNIZIONE SIFONE	1	PZ	VL1026A0	CURVA PER TUBO DI SCARICO	1	PZ	VM2039A0	ANELLO FISSAGGIO CURVA DI SCARICO	1	PZ								
Codice	Descrizione	Qtà	UM																										
GN1400A0	GUARNIZIONE SIFONE	1	PZ																										
VL1026A0	CURVA PER TUBO DI SCARICO	1	PZ																										
VM2039A0	ANELLO FISSAGGIO CURVA DI SCARICO	1	PZ																										
VM1505A	PASSAPARETE CON DIAFRAMMA		KVM1505A	KIT PASSAPARETE CON DIAFRAMMA	<table border="1"> <thead> <tr> <th>Codice</th> <th>Descrizione</th> <th>Qtà</th> <th>UM</th> </tr> </thead> <tbody> <tr> <td>VI1220A1</td> <td>VITE AUTOFILETTA NTE 4.2X11 TCS+ MARUTE</td> <td>1</td> <td>PZ</td> </tr> <tr> <td>VM1505A0</td> <td>PASSAPARETE CON DIAFRAMMA</td> <td>3</td> <td>PZ</td> </tr> <tr> <td>VM2055A0</td> <td>PASSAPARETE E CAVI ACCESSORI SUP.</td> <td>1</td> <td>PZ</td> </tr> <tr> <td>VM2056A0</td> <td>PASSAPARETE E CAVI ACCESSORI INF.</td> <td>1</td> <td>PZ</td> </tr> <tr> <td>VM2061A0</td> <td>PASSAPARETE E CAVI ACCESSORI COMPLETO</td> <td>1</td> <td>PZ</td> </tr> </tbody> </table>	Codice	Descrizione	Qtà	UM	VI1220A1	VITE AUTOFILETTA NTE 4.2X11 TCS+ MARUTE	1	PZ	VM1505A0	PASSAPARETE CON DIAFRAMMA	3	PZ	VM2055A0	PASSAPARETE E CAVI ACCESSORI SUP.	1	PZ	VM2056A0	PASSAPARETE E CAVI ACCESSORI INF.	1	PZ	VM2061A0	PASSAPARETE E CAVI ACCESSORI COMPLETO	1	PZ
Codice	Descrizione	Qtà	UM																										
VI1220A1	VITE AUTOFILETTA NTE 4.2X11 TCS+ MARUTE	1	PZ																										
VM1505A0	PASSAPARETE CON DIAFRAMMA	3	PZ																										
VM2055A0	PASSAPARETE E CAVI ACCESSORI SUP.	1	PZ																										
VM2056A0	PASSAPARETE E CAVI ACCESSORI INF.	1	PZ																										
VM2061A0	PASSAPARETE E CAVI ACCESSORI COMPLETO	1	PZ																										
VM1014A	ANELLO FISSAGGIO FORNO A PAVIMENT		KVM1014A	KIT 4 STAFFE FERMA FORNO A TERRA	<table border="1"> <thead> <tr> <th>Codice</th> <th>Descrizione</th> <th>Qtà</th> <th>UM</th> </tr> </thead> <tbody> <tr> <td>VM1014A0</td> <td>ANELLO FISSAGGIO FORNO A PAVIMENTO</td> <td>4</td> <td>PZ</td> </tr> </tbody> </table>	Codice	Descrizione	Qtà	UM	VM1014A0	ANELLO FISSAGGIO FORNO A PAVIMENTO	4	PZ																
Codice	Descrizione	Qtà	UM																										
VM1014A0	ANELLO FISSAGGIO FORNO A PAVIMENTO	4	PZ																										



COMPONENTE			RICAMBIO										
Codice	Descrizione	Immagine	Codice	Descrizione	Lista componenti								
VM2319A	SAPONETTA SOSTEGNO PORTA		KVM2319A	KIT SAPONETTA SOSTEGNO PORTA	<table border="1"><thead><tr><th>Codice</th><th>Descrizione</th><th>Qtà</th><th>UM</th></tr></thead><tbody><tr><td>VM2319A0</td><td>SAPONETTA SOSTEGNO PORTA</td><td>1</td><td>PZ</td></tr></tbody></table>	Codice	Descrizione	Qtà	UM	VM2319A0	SAPONETTA SOSTEGNO PORTA	1	PZ
Codice	Descrizione	Qtà	UM										
VM2319A0	SAPONETTA SOSTEGNO PORTA	1	PZ										

ASM1804A/0.D02 - Camera di cottura

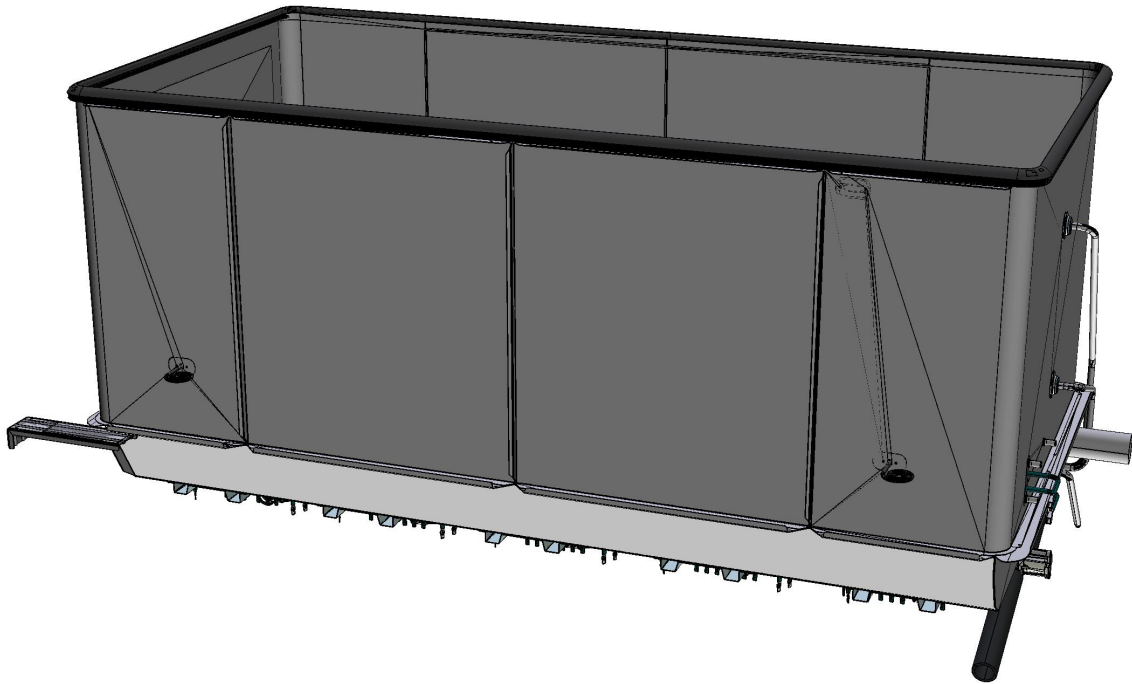

FRONTE



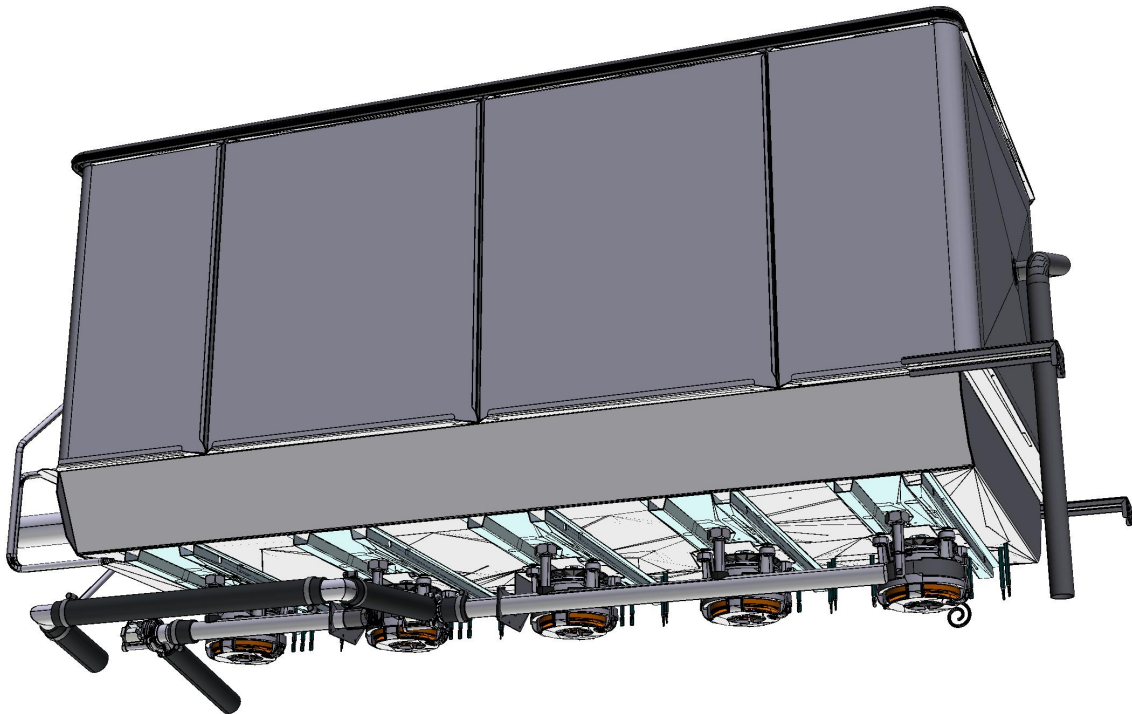

ASM1804A/0.D02 - Camera di cottura



RETRO





COMPONENTE			RICAMBIO																										
Codice	Descrizione	Immagine	Codice	Descrizione	Lista componenti																								
RS1215A	RESISTENZA FRENATA 147W 105V 1 SPIRA		KRS1215A	KIT RESISTENZA FRENATA 147W	<table border="1"> <thead> <tr> <th>Codice</th> <th>Descrizione</th> <th>Qtà</th> <th>UM</th> </tr> </thead> <tbody> <tr> <td>GN1326A1</td> <td>GUARNIZIONE RESISTENZA 71X19 G6.25</td> <td>1</td> <td>PZ</td> </tr> <tr> <td>RS1215A1</td> <td>RESISTENZA FRENATA 147W 105V 1 SPIRA</td> <td>1</td> <td>PZ</td> </tr> <tr> <td>SL1045A0</td> <td>SILICONE ANTRACITE S53 80 ML</td> <td>1</td> <td>PZ</td> </tr> <tr> <td>VI1220A1</td> <td>VITE AUTOFILETTA NTE 4.2X11 TCS+ MARUTE</td> <td>2</td> <td>PZ</td> </tr> <tr> <td>VM2147A0</td> <td>SPUGNA ESD ROSA LISCIA 410X343X15 M</td> <td>1</td> <td>PZ</td> </tr> </tbody> </table>	Codice	Descrizione	Qtà	UM	GN1326A1	GUARNIZIONE RESISTENZA 71X19 G6.25	1	PZ	RS1215A1	RESISTENZA FRENATA 147W 105V 1 SPIRA	1	PZ	SL1045A0	SILICONE ANTRACITE S53 80 ML	1	PZ	VI1220A1	VITE AUTOFILETTA NTE 4.2X11 TCS+ MARUTE	2	PZ	VM2147A0	SPUGNA ESD ROSA LISCIA 410X343X15 M	1	PZ
Codice	Descrizione	Qtà	UM																										
GN1326A1	GUARNIZIONE RESISTENZA 71X19 G6.25	1	PZ																										
RS1215A1	RESISTENZA FRENATA 147W 105V 1 SPIRA	1	PZ																										
SL1045A0	SILICONE ANTRACITE S53 80 ML	1	PZ																										
VI1220A1	VITE AUTOFILETTA NTE 4.2X11 TCS+ MARUTE	2	PZ																										
VM2147A0	SPUGNA ESD ROSA LISCIA 410X343X15 M	1	PZ																										
GN1326A	GUARNIZIONE RESISTENZA 71X19 G6.25		KRS1261A	KIT RESISTENZA FRENATA 122W	<table border="1"> <thead> <tr> <th>Codice</th> <th>Descrizione</th> <th>Qtà</th> <th>UM</th> </tr> </thead> <tbody> <tr> <td>GN1326A1</td> <td>GUARNIZIONE RESISTENZA 71X19 G6.25</td> <td>1</td> <td>PZ</td> </tr> <tr> <td>RS1261A0</td> <td>RESISTENZA MOTORE BAKERLUX\CH EFLUX</td> <td>1</td> <td>PZ</td> </tr> <tr> <td>SL1045A0</td> <td>SILICONE ANTRACITE S53 80 ML</td> <td>1</td> <td>PZ</td> </tr> <tr> <td>VI1220A1</td> <td>VITE AUTOFILETTA NTE 4.2X11 TCS+ MARUTE</td> <td>2</td> <td>PZ</td> </tr> <tr> <td>VM2147A0</td> <td>SPUGNA ESD ROSA LISCIA 410X343X15 M</td> <td>1</td> <td>PZ</td> </tr> </tbody> </table>	Codice	Descrizione	Qtà	UM	GN1326A1	GUARNIZIONE RESISTENZA 71X19 G6.25	1	PZ	RS1261A0	RESISTENZA MOTORE BAKERLUX\CH EFLUX	1	PZ	SL1045A0	SILICONE ANTRACITE S53 80 ML	1	PZ	VI1220A1	VITE AUTOFILETTA NTE 4.2X11 TCS+ MARUTE	2	PZ	VM2147A0	SPUGNA ESD ROSA LISCIA 410X343X15 M	1	PZ
Codice	Descrizione	Qtà	UM																										
GN1326A1	GUARNIZIONE RESISTENZA 71X19 G6.25	1	PZ																										
RS1261A0	RESISTENZA MOTORE BAKERLUX\CH EFLUX	1	PZ																										
SL1045A0	SILICONE ANTRACITE S53 80 ML	1	PZ																										
VI1220A1	VITE AUTOFILETTA NTE 4.2X11 TCS+ MARUTE	2	PZ																										
VM2147A0	SPUGNA ESD ROSA LISCIA 410X343X15 M	1	PZ																										
			KRS1215A	KIT RESISTENZA FRENATA 147W	<table border="1"> <thead> <tr> <th>Codice</th> <th>Descrizione</th> <th>Qtà</th> <th>UM</th> </tr> </thead> <tbody> <tr> <td>GN1326A1</td> <td>GUARNIZIONE RESISTENZA 71X19 G6.25</td> <td>1</td> <td>PZ</td> </tr> <tr> <td>RS1215A1</td> <td>RESISTENZA FRENATA 147W 105V 1 SPIRA</td> <td>1</td> <td>PZ</td> </tr> <tr> <td>SL1045A0</td> <td>SILICONE ANTRACITE S53 80 ML</td> <td>1</td> <td>PZ</td> </tr> <tr> <td>VI1220A1</td> <td>VITE AUTOFILETTA NTE 4.2X11 TCS+ MARUTE</td> <td>2</td> <td>PZ</td> </tr> <tr> <td>VM2147A0</td> <td>SPUGNA ESD ROSA LISCIA 410X343X15 M</td> <td>1</td> <td>PZ</td> </tr> </tbody> </table>	Codice	Descrizione	Qtà	UM	GN1326A1	GUARNIZIONE RESISTENZA 71X19 G6.25	1	PZ	RS1215A1	RESISTENZA FRENATA 147W 105V 1 SPIRA	1	PZ	SL1045A0	SILICONE ANTRACITE S53 80 ML	1	PZ	VI1220A1	VITE AUTOFILETTA NTE 4.2X11 TCS+ MARUTE	2	PZ	VM2147A0	SPUGNA ESD ROSA LISCIA 410X343X15 M	1	PZ
Codice	Descrizione	Qtà	UM																										
GN1326A1	GUARNIZIONE RESISTENZA 71X19 G6.25	1	PZ																										
RS1215A1	RESISTENZA FRENATA 147W 105V 1 SPIRA	1	PZ																										
SL1045A0	SILICONE ANTRACITE S53 80 ML	1	PZ																										
VI1220A1	VITE AUTOFILETTA NTE 4.2X11 TCS+ MARUTE	2	PZ																										
VM2147A0	SPUGNA ESD ROSA LISCIA 410X343X15 M	1	PZ																										

COMPONENTE			RICAMBIO																																		
Codice	Descrizione	Immagine	Codice	Descrizione	Lista componenti																																
GN1326A	GUARNIZIONE RESISTENZA 71X19 G6.25		KRS1095A	KIT RESISTENZA 1.2KW	<table border="1"> <thead> <tr> <th>Codice</th> <th>Descrizione</th> <th>Qtà</th> <th>UM</th> </tr> </thead> <tbody> <tr> <td>GN1326A1</td> <td>GUARNIZIONE RESISTENZA 71X19 G6.25</td> <td>1</td> <td>PZ</td> </tr> <tr> <td>IP1385A0</td> <td>IMBALLO POLISTIROLO ANGOLARE 110X80X2000</td> <td>1.200</td> <td>PZ</td> </tr> <tr> <td>IP1385A1</td> <td>IMB POL ANGOLARE 110X80X2000 D30</td> <td>0.500</td> <td>M</td> </tr> <tr> <td>RS1095A1</td> <td>RESISTENZA PIANA 1200W 230V</td> <td>1</td> <td>PZ</td> </tr> <tr> <td>SL1045A0</td> <td>SILICONE ANTRACITE S53 80 ML</td> <td>1</td> <td>PZ</td> </tr> <tr> <td>VI1220A1</td> <td>VITE AUTOFILETTA NTE 4.2X11 TCS+ MARUTE</td> <td>2</td> <td>PZ</td> </tr> <tr> <td>VM1059A1</td> <td>FILM TERMORETRA IBILE H800</td> <td>1.200</td> <td>M</td> </tr> </tbody> </table>	Codice	Descrizione	Qtà	UM	GN1326A1	GUARNIZIONE RESISTENZA 71X19 G6.25	1	PZ	IP1385A0	IMBALLO POLISTIROLO ANGOLARE 110X80X2000	1.200	PZ	IP1385A1	IMB POL ANGOLARE 110X80X2000 D30	0.500	M	RS1095A1	RESISTENZA PIANA 1200W 230V	1	PZ	SL1045A0	SILICONE ANTRACITE S53 80 ML	1	PZ	VI1220A1	VITE AUTOFILETTA NTE 4.2X11 TCS+ MARUTE	2	PZ	VM1059A1	FILM TERMORETRA IBILE H800	1.200	M
			Codice	Descrizione	Qtà	UM																															
			GN1326A1	GUARNIZIONE RESISTENZA 71X19 G6.25	1	PZ																															
IP1385A0	IMBALLO POLISTIROLO ANGOLARE 110X80X2000	1.200	PZ																																		
IP1385A1	IMB POL ANGOLARE 110X80X2000 D30	0.500	M																																		
RS1095A1	RESISTENZA PIANA 1200W 230V	1	PZ																																		
SL1045A0	SILICONE ANTRACITE S53 80 ML	1	PZ																																		
VI1220A1	VITE AUTOFILETTA NTE 4.2X11 TCS+ MARUTE	2	PZ																																		
VM1059A1	FILM TERMORETRA IBILE H800	1.200	M																																		
KRS1012A	KIT RESISTENZA 1365W 120V	<table border="1"> <thead> <tr> <th>Codice</th> <th>Descrizione</th> <th>Qtà</th> <th>UM</th> </tr> </thead> <tbody> <tr> <td>GN1326A1</td> <td>GUARNIZIONE RESISTENZA 71X19 G6.25</td> <td>1</td> <td>PZ</td> </tr> <tr> <td>RS1012A0</td> <td>RESISTENZA CIRCOLARE 1365W 120V</td> <td>1</td> <td>PZ</td> </tr> <tr> <td>VI1220A1</td> <td>VITE AUTOFILETTA NTE 4.2X11 TCS+ MARUTE</td> <td>5</td> <td>PZ</td> </tr> <tr> <td>VM1794A0</td> <td>FASCETTA 250X4.8 PA66 NERA</td> <td>2</td> <td>PZ</td> </tr> <tr> <td>VM2103A0</td> <td>PIASTRINA FERMAFASCE TTA</td> <td>2</td> <td>PZ</td> </tr> </tbody> </table>	Codice	Descrizione	Qtà	UM	GN1326A1	GUARNIZIONE RESISTENZA 71X19 G6.25	1	PZ	RS1012A0	RESISTENZA CIRCOLARE 1365W 120V	1	PZ	VI1220A1	VITE AUTOFILETTA NTE 4.2X11 TCS+ MARUTE	5	PZ	VM1794A0	FASCETTA 250X4.8 PA66 NERA	2	PZ	VM2103A0	PIASTRINA FERMAFASCE TTA	2	PZ											
Codice	Descrizione	Qtà	UM																																		
GN1326A1	GUARNIZIONE RESISTENZA 71X19 G6.25	1	PZ																																		
RS1012A0	RESISTENZA CIRCOLARE 1365W 120V	1	PZ																																		
VI1220A1	VITE AUTOFILETTA NTE 4.2X11 TCS+ MARUTE	5	PZ																																		
VM1794A0	FASCETTA 250X4.8 PA66 NERA	2	PZ																																		
VM2103A0	PIASTRINA FERMAFASCE TTA	2	PZ																																		
KRS1011A	KIT RESISTENZA ROBERTA/LISA	<table border="1"> <thead> <tr> <th>Codice</th> <th>Descrizione</th> <th>Qtà</th> <th>UM</th> </tr> </thead> <tbody> <tr> <td>GN1326A1</td> <td>GUARNIZIONE RESISTENZA 71X19 G6.25</td> <td>1</td> <td>PZ</td> </tr> <tr> <td>RS1011A0</td> <td>RESISTENZA CIRCOLARE 2560W 220-230</td> <td>1</td> <td>PZ</td> </tr> <tr> <td>SL1045A0</td> <td>SILICONE ANTRACITE S53 80 ML</td> <td>1</td> <td>PZ</td> </tr> </tbody> </table>	Codice	Descrizione	Qtà	UM	GN1326A1	GUARNIZIONE RESISTENZA 71X19 G6.25	1	PZ	RS1011A0	RESISTENZA CIRCOLARE 2560W 220-230	1	PZ	SL1045A0	SILICONE ANTRACITE S53 80 ML	1	PZ																			
Codice	Descrizione	Qtà	UM																																		
GN1326A1	GUARNIZIONE RESISTENZA 71X19 G6.25	1	PZ																																		
RS1011A0	RESISTENZA CIRCOLARE 2560W 220-230	1	PZ																																		
SL1045A0	SILICONE ANTRACITE S53 80 ML	1	PZ																																		

COMPONENTE			RICAMBIO																							
Codice	Descrizione	Immagine	Codice	Descrizione	Lista componenti																					
GN1326A	GUARNIZIONE RESISTENZA 71X19 G6.25		KRS1011A	KIT RESISTENZA ROBERTA/LISA	<table border="1"> <thead> <tr> <th>Codice</th> <th>Descrizione</th> <th>Qtà</th> <th>UM</th> </tr> </thead> <tbody> <tr> <td>VI1220A1</td> <td>VITE AUTOFILETTA NTE 4.2X11 TCS+ MARUTE</td> <td>5</td> <td>PZ</td> </tr> <tr> <td>VM1794A0</td> <td>FASCETTA 250X4.8 PA66 NERA</td> <td>2</td> <td>PZ</td> </tr> <tr> <td>VM2103A0</td> <td>PIASTRINA FERMAFASCE TTA</td> <td>2</td> <td>PZ</td> </tr> </tbody> </table>	Codice	Descrizione	Qtà	UM	VI1220A1	VITE AUTOFILETTA NTE 4.2X11 TCS+ MARUTE	5	PZ	VM1794A0	FASCETTA 250X4.8 PA66 NERA	2	PZ	VM2103A0	PIASTRINA FERMAFASCE TTA	2	PZ					
			Codice	Descrizione	Qtà	UM																				
			VI1220A1	VITE AUTOFILETTA NTE 4.2X11 TCS+ MARUTE	5	PZ																				
			VM1794A0	FASCETTA 250X4.8 PA66 NERA	2	PZ																				
VM2103A0	PIASTRINA FERMAFASCE TTA	2	PZ																							
KRS0090A	KIT RESISTENZA 1.26KW	<table border="1"> <thead> <tr> <th>Codice</th> <th>Descrizione</th> <th>Qtà</th> <th>UM</th> </tr> </thead> <tbody> <tr> <td>GN1326A1</td> <td>GUARNIZIONE RESISTENZA 71X19 G6.25</td> <td>1</td> <td>PZ</td> </tr> <tr> <td>RS0090A0</td> <td>RESISTENZA CIRCOLARE 1260W 220-230</td> <td>1</td> <td>PZ</td> </tr> <tr> <td>VI1220A1</td> <td>VITE AUTOFILETTA NTE 4.2X11 TCS+ MARUTE</td> <td>3</td> <td>PZ</td> </tr> <tr> <td>VM1794A0</td> <td>FASCETTA 250X4.8 PA66 NERA</td> <td>2</td> <td>PZ</td> </tr> <tr> <td>VM2103A0</td> <td>PIASTRINA FERMAFASCE TTA</td> <td>2</td> <td>PZ</td> </tr> </tbody> </table>	Codice	Descrizione	Qtà	UM	GN1326A1	GUARNIZIONE RESISTENZA 71X19 G6.25	1	PZ	RS0090A0	RESISTENZA CIRCOLARE 1260W 220-230	1	PZ	VI1220A1	VITE AUTOFILETTA NTE 4.2X11 TCS+ MARUTE	3	PZ	VM1794A0	FASCETTA 250X4.8 PA66 NERA	2	PZ	VM2103A0	PIASTRINA FERMAFASCE TTA	2	PZ
Codice	Descrizione	Qtà	UM																							
GN1326A1	GUARNIZIONE RESISTENZA 71X19 G6.25	1	PZ																							
RS0090A0	RESISTENZA CIRCOLARE 1260W 220-230	1	PZ																							
VI1220A1	VITE AUTOFILETTA NTE 4.2X11 TCS+ MARUTE	3	PZ																							
VM1794A0	FASCETTA 250X4.8 PA66 NERA	2	PZ																							
VM2103A0	PIASTRINA FERMAFASCE TTA	2	PZ																							
KRS0050A	KIT RESISTENZA 0.5KW	<table border="1"> <thead> <tr> <th>Codice</th> <th>Descrizione</th> <th>Qtà</th> <th>UM</th> </tr> </thead> <tbody> <tr> <td>GN1326A1</td> <td>GUARNIZIONE RESISTENZA 71X19 G6.25</td> <td>1</td> <td>PZ</td> </tr> <tr> <td>IP1075A1</td> <td>IMB POL 70X150X765 D=10 CON PRETAGLIO</td> <td>1</td> <td>PZ</td> </tr> <tr> <td>IP1080A1</td> <td>IMB POL 280X255X10 D=10</td> <td>1</td> <td>PZ</td> </tr> <tr> <td>RS0050A0</td> <td>RESISTENZA PIANA 500W 220-230V</td> <td>1</td> <td>PZ</td> </tr> <tr> <td>VI1220A1</td> <td>VITE AUTOFILETTA NTE 4.2X11 TCS+ MARUTE</td> <td>2</td> <td>PZ</td> </tr> </tbody> </table>	Codice	Descrizione	Qtà	UM	GN1326A1	GUARNIZIONE RESISTENZA 71X19 G6.25	1	PZ	IP1075A1	IMB POL 70X150X765 D=10 CON PRETAGLIO	1	PZ	IP1080A1	IMB POL 280X255X10 D=10	1	PZ	RS0050A0	RESISTENZA PIANA 500W 220-230V	1	PZ	VI1220A1	VITE AUTOFILETTA NTE 4.2X11 TCS+ MARUTE	2	PZ
Codice	Descrizione	Qtà	UM																							
GN1326A1	GUARNIZIONE RESISTENZA 71X19 G6.25	1	PZ																							
IP1075A1	IMB POL 70X150X765 D=10 CON PRETAGLIO	1	PZ																							
IP1080A1	IMB POL 280X255X10 D=10	1	PZ																							
RS0050A0	RESISTENZA PIANA 500W 220-230V	1	PZ																							
VI1220A1	VITE AUTOFILETTA NTE 4.2X11 TCS+ MARUTE	2	PZ																							
KRS0011A	KIT RESISTENZA 1.465KW RS0011A	<table border="1"> <thead> <tr> <th>Codice</th> <th>Descrizione</th> <th>Qtà</th> <th>UM</th> </tr> </thead> <tbody> <tr> <td>GN1326A1</td> <td>GUARNIZIONE RESISTENZA 71X19 G6.25</td> <td>1</td> <td>PZ</td> </tr> </tbody> </table>	Codice	Descrizione	Qtà	UM	GN1326A1	GUARNIZIONE RESISTENZA 71X19 G6.25	1	PZ																
Codice	Descrizione	Qtà	UM																							
GN1326A1	GUARNIZIONE RESISTENZA 71X19 G6.25	1	PZ																							



COMPONENTE			RICAMBIO																										
Codice	Descrizione	Immagine	Codice	Descrizione	Lista componenti																								
GN1326A	GUARNIZIONE RESISTENZA 71X19 G6.25		KRS0011A	KIT RESISTENZA 1.465KW RS0011A	<table border="1"> <thead> <tr> <th>Codice</th> <th>Descrizione</th> <th>Qtà</th> <th>UM</th> </tr> </thead> <tbody> <tr> <td>RS0011A0</td> <td>RESISTENZA CIRCOLARE 1465W 220-230</td> <td>1</td> <td>PZ</td> </tr> <tr> <td>VI1220A1</td> <td>VITE AUTOFILETTA NTE 4.2X11 TCS+ MARUTE</td> <td>3</td> <td>PZ</td> </tr> <tr> <td>VM1794A0</td> <td>FASCETTA 250X4.8 PA66 NERA</td> <td>2</td> <td>PZ</td> </tr> <tr> <td>VM2103A0</td> <td>PIASTRINA FERMAFASCE TTA</td> <td>2</td> <td>PZ</td> </tr> </tbody> </table>	Codice	Descrizione	Qtà	UM	RS0011A0	RESISTENZA CIRCOLARE 1465W 220-230	1	PZ	VI1220A1	VITE AUTOFILETTA NTE 4.2X11 TCS+ MARUTE	3	PZ	VM1794A0	FASCETTA 250X4.8 PA66 NERA	2	PZ	VM2103A0	PIASTRINA FERMAFASCE TTA	2	PZ				
			Codice	Descrizione	Qtà	UM																							
			RS0011A0	RESISTENZA CIRCOLARE 1465W 220-230	1	PZ																							
VI1220A1	VITE AUTOFILETTA NTE 4.2X11 TCS+ MARUTE	3	PZ																										
VM1794A0	FASCETTA 250X4.8 PA66 NERA	2	PZ																										
VM2103A0	PIASTRINA FERMAFASCE TTA	2	PZ																										
KRS0010A	KIT RESISTENZA RS0010A	<table border="1"> <thead> <tr> <th>Codice</th> <th>Descrizione</th> <th>Qtà</th> <th>UM</th> </tr> </thead> <tbody> <tr> <td>GN1326A1</td> <td>GUARNIZIONE RESISTENZA 71X19 G6.25</td> <td>1</td> <td>PZ</td> </tr> <tr> <td>IP1075A1</td> <td>IMB POL 70X150X765 D=10 CON PRETAGLIO</td> <td>1</td> <td>PZ</td> </tr> <tr> <td>IP1080A1</td> <td>IMB POL 280X255X10 D=10</td> <td>5</td> <td>PZ</td> </tr> <tr> <td>RS0010A0</td> <td>RESISTENZA CIRCOLARE 2560W 220-230</td> <td>1</td> <td>PZ</td> </tr> <tr> <td>VI1220A1</td> <td>VITE AUTOFILETTA NTE 4.2X11 TCS+ MARUTE</td> <td>3</td> <td>PZ</td> </tr> </tbody> </table>	Codice	Descrizione	Qtà	UM	GN1326A1	GUARNIZIONE RESISTENZA 71X19 G6.25	1	PZ	IP1075A1	IMB POL 70X150X765 D=10 CON PRETAGLIO	1	PZ	IP1080A1	IMB POL 280X255X10 D=10	5	PZ	RS0010A0	RESISTENZA CIRCOLARE 2560W 220-230	1	PZ	VI1220A1	VITE AUTOFILETTA NTE 4.2X11 TCS+ MARUTE	3	PZ			
Codice	Descrizione	Qtà	UM																										
GN1326A1	GUARNIZIONE RESISTENZA 71X19 G6.25	1	PZ																										
IP1075A1	IMB POL 70X150X765 D=10 CON PRETAGLIO	1	PZ																										
IP1080A1	IMB POL 280X255X10 D=10	5	PZ																										
RS0010A0	RESISTENZA CIRCOLARE 2560W 220-230	1	PZ																										
VI1220A1	VITE AUTOFILETTA NTE 4.2X11 TCS+ MARUTE	3	PZ																										
KGN1326A	KIT 5 PZ GUARNIZIONE RESISTENZA	<table border="1"> <thead> <tr> <th>Codice</th> <th>Descrizione</th> <th>Qtà</th> <th>UM</th> </tr> </thead> <tbody> <tr> <td>GN1326A1</td> <td>GUARNIZIONE RESISTENZA 71X19 G6.25</td> <td>5</td> <td>PZ</td> </tr> </tbody> </table>	Codice	Descrizione	Qtà	UM	GN1326A1	GUARNIZIONE RESISTENZA 71X19 G6.25	5	PZ																			
Codice	Descrizione	Qtà	UM																										
GN1326A1	GUARNIZIONE RESISTENZA 71X19 G6.25	5	PZ																										
GN1326A	GUARNIZIONE RESISTENZA 71X19 G6.25		KRS1261A	GNT1326A1 KIT RESISTENZA FRENATA 122W	<table border="1"> <thead> <tr> <th>Codice</th> <th>Descrizione</th> <th>Qtà</th> <th>UM</th> </tr> </thead> <tbody> <tr> <td>GN1326A1</td> <td>GUARNIZIONE RESISTENZA 71X19 G6.25</td> <td>1</td> <td>PZ</td> </tr> <tr> <td>RS1261A0</td> <td>RESISTENZA MOTORE BAKERLUX\CH EFLUX</td> <td>1</td> <td>PZ</td> </tr> <tr> <td>SL1045A0</td> <td>SILICONE ANTRACITE S53 80 ML</td> <td>1</td> <td>PZ</td> </tr> <tr> <td>VI1220A1</td> <td>VITE AUTOFILETTA NTE 4.2X11 TCS+ MARUTE</td> <td>2</td> <td>PZ</td> </tr> <tr> <td>VM2147A0</td> <td>SPUGNA ESD ROSA LISCIA 410X343X15 M</td> <td>1</td> <td>PZ</td> </tr> </tbody> </table>	Codice	Descrizione	Qtà	UM	GN1326A1	GUARNIZIONE RESISTENZA 71X19 G6.25	1	PZ	RS1261A0	RESISTENZA MOTORE BAKERLUX\CH EFLUX	1	PZ	SL1045A0	SILICONE ANTRACITE S53 80 ML	1	PZ	VI1220A1	VITE AUTOFILETTA NTE 4.2X11 TCS+ MARUTE	2	PZ	VM2147A0	SPUGNA ESD ROSA LISCIA 410X343X15 M	1	PZ
Codice	Descrizione	Qtà	UM																										
GN1326A1	GUARNIZIONE RESISTENZA 71X19 G6.25	1	PZ																										
RS1261A0	RESISTENZA MOTORE BAKERLUX\CH EFLUX	1	PZ																										
SL1045A0	SILICONE ANTRACITE S53 80 ML	1	PZ																										
VI1220A1	VITE AUTOFILETTA NTE 4.2X11 TCS+ MARUTE	2	PZ																										
VM2147A0	SPUGNA ESD ROSA LISCIA 410X343X15 M	1	PZ																										

COMPONENTE			RICAMBIO																															
Codice	Descrizione	Immagine	Codice	Descrizione	Lista componenti																													
GN1326A	GUARNIZIONE RESISTENZA 71X19 G6.25		KRS1215A	KIT RESISTENZA FRENATA 147W	<table border="1"> <thead> <tr> <th>Codice</th> <th>Descrizione</th> <th>Qtà</th> <th>UM</th> </tr> </thead> <tbody> <tr> <td>GN1326A1</td> <td>GUARNIZIONE RESISTENZA 71X19 G6.25</td> <td>1</td> <td>PZ</td> </tr> <tr> <td>RS1215A1</td> <td>RESISTENZA FRENATA 147W 105V 1 SPIRA</td> <td>1</td> <td>PZ</td> </tr> <tr> <td>SL1045A0</td> <td>SILICONE ANTRACITE S53 80 ML</td> <td>1</td> <td>PZ</td> </tr> <tr> <td>VI1220A1</td> <td>VITE AUTOFILETTA NTE 4.2X11 TCS+ MARUTE</td> <td>2</td> <td>PZ</td> </tr> <tr> <td>VM2147A0</td> <td>SPUGNA ESD ROSA LISCIA 410X343X15 M</td> <td>1</td> <td>PZ</td> </tr> </tbody> </table>	Codice	Descrizione	Qtà	UM	GN1326A1	GUARNIZIONE RESISTENZA 71X19 G6.25	1	PZ	RS1215A1	RESISTENZA FRENATA 147W 105V 1 SPIRA	1	PZ	SL1045A0	SILICONE ANTRACITE S53 80 ML	1	PZ	VI1220A1	VITE AUTOFILETTA NTE 4.2X11 TCS+ MARUTE	2	PZ	VM2147A0	SPUGNA ESD ROSA LISCIA 410X343X15 M	1	PZ					
			Codice	Descrizione	Qtà	UM																												
			GN1326A1	GUARNIZIONE RESISTENZA 71X19 G6.25	1	PZ																												
RS1215A1	RESISTENZA FRENATA 147W 105V 1 SPIRA	1	PZ																															
SL1045A0	SILICONE ANTRACITE S53 80 ML	1	PZ																															
VI1220A1	VITE AUTOFILETTA NTE 4.2X11 TCS+ MARUTE	2	PZ																															
VM2147A0	SPUGNA ESD ROSA LISCIA 410X343X15 M	1	PZ																															
KRS1095A	KIT RESISTENZA 1.2KW	<table border="1"> <thead> <tr> <th>Codice</th> <th>Descrizione</th> <th>Qtà</th> <th>UM</th> </tr> </thead> <tbody> <tr> <td>GN1326A1</td> <td>GUARNIZIONE RESISTENZA 71X19 G6.25</td> <td>1</td> <td>PZ</td> </tr> <tr> <td>IP1385A0</td> <td>IMBALLO POLISTIROLO ANGOLARE 110X80X2000</td> <td>1.200</td> <td>PZ</td> </tr> <tr> <td>IP1385A1</td> <td>IMB POL ANGOLARE 110X80X2000 D30</td> <td>0.500</td> <td>M</td> </tr> <tr> <td>RS1095A1</td> <td>RESISTENZA PIANA 1200W 230V</td> <td>1</td> <td>PZ</td> </tr> <tr> <td>SL1045A0</td> <td>SILICONE ANTRACITE S53 80 ML</td> <td>1</td> <td>PZ</td> </tr> <tr> <td>VI1220A1</td> <td>VITE AUTOFILETTA NTE 4.2X11 TCS+ MARUTE</td> <td>2</td> <td>PZ</td> </tr> <tr> <td>VM1059A1</td> <td>FILM TERMORETRA IBILE H800</td> <td>1.200</td> <td>M</td> </tr> </tbody> </table>	Codice	Descrizione	Qtà	UM	GN1326A1	GUARNIZIONE RESISTENZA 71X19 G6.25	1	PZ	IP1385A0	IMBALLO POLISTIROLO ANGOLARE 110X80X2000	1.200	PZ	IP1385A1	IMB POL ANGOLARE 110X80X2000 D30	0.500	M	RS1095A1	RESISTENZA PIANA 1200W 230V	1	PZ	SL1045A0	SILICONE ANTRACITE S53 80 ML	1	PZ	VI1220A1	VITE AUTOFILETTA NTE 4.2X11 TCS+ MARUTE	2	PZ	VM1059A1	FILM TERMORETRA IBILE H800	1.200	M
Codice	Descrizione	Qtà	UM																															
GN1326A1	GUARNIZIONE RESISTENZA 71X19 G6.25	1	PZ																															
IP1385A0	IMBALLO POLISTIROLO ANGOLARE 110X80X2000	1.200	PZ																															
IP1385A1	IMB POL ANGOLARE 110X80X2000 D30	0.500	M																															
RS1095A1	RESISTENZA PIANA 1200W 230V	1	PZ																															
SL1045A0	SILICONE ANTRACITE S53 80 ML	1	PZ																															
VI1220A1	VITE AUTOFILETTA NTE 4.2X11 TCS+ MARUTE	2	PZ																															
VM1059A1	FILM TERMORETRA IBILE H800	1.200	M																															
KRS1012A	KIT RESISTENZA 1365W 120V	<table border="1"> <thead> <tr> <th>Codice</th> <th>Descrizione</th> <th>Qtà</th> <th>UM</th> </tr> </thead> <tbody> <tr> <td>GN1326A1</td> <td>GUARNIZIONE RESISTENZA 71X19 G6.25</td> <td>1</td> <td>PZ</td> </tr> <tr> <td>RS1012A0</td> <td>RESISTENZA CIRCOLARE 1365W 120V</td> <td>1</td> <td>PZ</td> </tr> <tr> <td>VI1220A1</td> <td>VITE AUTOFILETTA NTE 4.2X11 TCS+ MARUTE</td> <td>5</td> <td>PZ</td> </tr> </tbody> </table>	Codice	Descrizione	Qtà	UM	GN1326A1	GUARNIZIONE RESISTENZA 71X19 G6.25	1	PZ	RS1012A0	RESISTENZA CIRCOLARE 1365W 120V	1	PZ	VI1220A1	VITE AUTOFILETTA NTE 4.2X11 TCS+ MARUTE	5	PZ																
Codice	Descrizione	Qtà	UM																															
GN1326A1	GUARNIZIONE RESISTENZA 71X19 G6.25	1	PZ																															
RS1012A0	RESISTENZA CIRCOLARE 1365W 120V	1	PZ																															
VI1220A1	VITE AUTOFILETTA NTE 4.2X11 TCS+ MARUTE	5	PZ																															



COMPONENTE			RICAMBIO																											
Codice	Descrizione	Immagine	Codice	Descrizione	Lista componenti																									
GN1326A	GUARNIZIONE RESISTENZA 71X19 G6.25		KRS1012A	KIT RESISTENZA 1365W 120V	<table border="1"> <thead> <tr> <th>Codice</th> <th>Descrizione</th> <th>Qtà</th> <th>UM</th> </tr> </thead> <tbody> <tr> <td>VM1794A0</td> <td>FASCETTA 250X4.8 PA66 NERA</td> <td>2</td> <td>PZ</td> </tr> <tr> <td>VM2103A0</td> <td>PIASTRINA FERMAFASCE TTA</td> <td>2</td> <td>PZ</td> </tr> </tbody> </table>	Codice	Descrizione	Qtà	UM	VM1794A0	FASCETTA 250X4.8 PA66 NERA	2	PZ	VM2103A0	PIASTRINA FERMAFASCE TTA	2	PZ													
			Codice	Descrizione	Qtà	UM																								
			VM1794A0	FASCETTA 250X4.8 PA66 NERA	2	PZ																								
			VM2103A0	PIASTRINA FERMAFASCE TTA	2	PZ																								
KRS1011A	KIT RESISTENZA ROBERTA/LISA	<table border="1"> <thead> <tr> <th>Codice</th> <th>Descrizione</th> <th>Qtà</th> <th>UM</th> </tr> </thead> <tbody> <tr> <td>GN1326A1</td> <td>GUARNIZIONE RESISTENZA 71X19 G6.25</td> <td>1</td> <td>PZ</td> </tr> <tr> <td>RS1011A0</td> <td>RESISTENZA CIRCOLARE 2560W 220-230</td> <td>1</td> <td>PZ</td> </tr> <tr> <td>SL1045A0</td> <td>SILICONE ANTRACITE S53 80 ML</td> <td>1</td> <td>PZ</td> </tr> <tr> <td>VI1220A1</td> <td>VITE AUTOFILETTA NTE 4.2X11 TCS+ MARUTE</td> <td>5</td> <td>PZ</td> </tr> <tr> <td>VM1794A0</td> <td>FASCETTA 250X4.8 PA66 NERA</td> <td>2</td> <td>PZ</td> </tr> <tr> <td>VM2103A0</td> <td>PIASTRINA FERMAFASCE TTA</td> <td>2</td> <td>PZ</td> </tr> </tbody> </table>	Codice	Descrizione	Qtà	UM	GN1326A1	GUARNIZIONE RESISTENZA 71X19 G6.25	1	PZ	RS1011A0	RESISTENZA CIRCOLARE 2560W 220-230	1	PZ	SL1045A0	SILICONE ANTRACITE S53 80 ML	1	PZ	VI1220A1	VITE AUTOFILETTA NTE 4.2X11 TCS+ MARUTE	5	PZ	VM1794A0	FASCETTA 250X4.8 PA66 NERA	2	PZ	VM2103A0	PIASTRINA FERMAFASCE TTA	2	PZ
Codice	Descrizione	Qtà	UM																											
GN1326A1	GUARNIZIONE RESISTENZA 71X19 G6.25	1	PZ																											
RS1011A0	RESISTENZA CIRCOLARE 2560W 220-230	1	PZ																											
SL1045A0	SILICONE ANTRACITE S53 80 ML	1	PZ																											
VI1220A1	VITE AUTOFILETTA NTE 4.2X11 TCS+ MARUTE	5	PZ																											
VM1794A0	FASCETTA 250X4.8 PA66 NERA	2	PZ																											
VM2103A0	PIASTRINA FERMAFASCE TTA	2	PZ																											
KRS0090A	KIT RESISTENZA 1.26KW	<table border="1"> <thead> <tr> <th>Codice</th> <th>Descrizione</th> <th>Qtà</th> <th>UM</th> </tr> </thead> <tbody> <tr> <td>GN1326A1</td> <td>GUARNIZIONE RESISTENZA 71X19 G6.25</td> <td>1</td> <td>PZ</td> </tr> <tr> <td>RS0090A0</td> <td>RESISTENZA CIRCOLARE 1260W 220-230</td> <td>1</td> <td>PZ</td> </tr> <tr> <td>VI1220A1</td> <td>VITE AUTOFILETTA NTE 4.2X11 TCS+ MARUTE</td> <td>3</td> <td>PZ</td> </tr> <tr> <td>VM1794A0</td> <td>FASCETTA 250X4.8 PA66 NERA</td> <td>2</td> <td>PZ</td> </tr> <tr> <td>VM2103A0</td> <td>PIASTRINA FERMAFASCE TTA</td> <td>2</td> <td>PZ</td> </tr> </tbody> </table>	Codice	Descrizione	Qtà	UM	GN1326A1	GUARNIZIONE RESISTENZA 71X19 G6.25	1	PZ	RS0090A0	RESISTENZA CIRCOLARE 1260W 220-230	1	PZ	VI1220A1	VITE AUTOFILETTA NTE 4.2X11 TCS+ MARUTE	3	PZ	VM1794A0	FASCETTA 250X4.8 PA66 NERA	2	PZ	VM2103A0	PIASTRINA FERMAFASCE TTA	2	PZ				
Codice	Descrizione	Qtà	UM																											
GN1326A1	GUARNIZIONE RESISTENZA 71X19 G6.25	1	PZ																											
RS0090A0	RESISTENZA CIRCOLARE 1260W 220-230	1	PZ																											
VI1220A1	VITE AUTOFILETTA NTE 4.2X11 TCS+ MARUTE	3	PZ																											
VM1794A0	FASCETTA 250X4.8 PA66 NERA	2	PZ																											
VM2103A0	PIASTRINA FERMAFASCE TTA	2	PZ																											
KRS0050A	KIT RESISTENZA 0.5KW	<table border="1"> <thead> <tr> <th>Codice</th> <th>Descrizione</th> <th>Qtà</th> <th>UM</th> </tr> </thead> <tbody> <tr> <td>GN1326A1</td> <td>GUARNIZIONE RESISTENZA 71X19 G6.25</td> <td>1</td> <td>PZ</td> </tr> <tr> <td>IP1075A1</td> <td>IMB POL 70X150X765 D=10 CON PRETAGLIO</td> <td>1</td> <td>PZ</td> </tr> </tbody> </table>	Codice	Descrizione	Qtà	UM	GN1326A1	GUARNIZIONE RESISTENZA 71X19 G6.25	1	PZ	IP1075A1	IMB POL 70X150X765 D=10 CON PRETAGLIO	1	PZ																
Codice	Descrizione	Qtà	UM																											
GN1326A1	GUARNIZIONE RESISTENZA 71X19 G6.25	1	PZ																											
IP1075A1	IMB POL 70X150X765 D=10 CON PRETAGLIO	1	PZ																											



COMPONENTE			RICAMBIO																							
Codice	Descrizione	Immagine	Codice	Descrizione	Lista componenti																					
GN1326A	GUARNIZIONE RESISTENZA 71X19 G6.25		KRS0050A	KIT RESISTENZA 0.5KW	<table border="1"> <thead> <tr> <th>Codice</th> <th>Descrizione</th> <th>Qtà</th> <th>UM</th> </tr> </thead> <tbody> <tr> <td>IP1080A1</td> <td>IMB POL 280X255X10 D=10</td> <td>1</td> <td>PZ</td> </tr> <tr> <td>RS0050A0</td> <td>RESISTENZA PIANA 500W 220-230V</td> <td>1</td> <td>PZ</td> </tr> <tr> <td>VI1220A1</td> <td>VITE AUTOFILETTA NTE 4.2X11 TCS+ MARUTE</td> <td>2</td> <td>PZ</td> </tr> </tbody> </table>	Codice	Descrizione	Qtà	UM	IP1080A1	IMB POL 280X255X10 D=10	1	PZ	RS0050A0	RESISTENZA PIANA 500W 220-230V	1	PZ	VI1220A1	VITE AUTOFILETTA NTE 4.2X11 TCS+ MARUTE	2	PZ					
			Codice	Descrizione	Qtà	UM																				
			IP1080A1	IMB POL 280X255X10 D=10	1	PZ																				
			RS0050A0	RESISTENZA PIANA 500W 220-230V	1	PZ																				
VI1220A1	VITE AUTOFILETTA NTE 4.2X11 TCS+ MARUTE	2	PZ																							
KRS0011A	KIT RESISTENZA 1.465KW RS0011A	<table border="1"> <thead> <tr> <th>Codice</th> <th>Descrizione</th> <th>Qtà</th> <th>UM</th> </tr> </thead> <tbody> <tr> <td>GN1326A1</td> <td>GUARNIZIONE RESISTENZA 71X19 G6.25</td> <td>1</td> <td>PZ</td> </tr> <tr> <td>RS0011A0</td> <td>RESISTENZA CIRCOLARE 1465W 220-230</td> <td>1</td> <td>PZ</td> </tr> <tr> <td>VI1220A1</td> <td>VITE AUTOFILETTA NTE 4.2X11 TCS+ MARUTE</td> <td>3</td> <td>PZ</td> </tr> <tr> <td>VM1794A0</td> <td>FASCETTA 250X4.8 PA66 NERA</td> <td>2</td> <td>PZ</td> </tr> <tr> <td>VM2103A0</td> <td>PIASTRINA FERMAFASCE TTA</td> <td>2</td> <td>PZ</td> </tr> </tbody> </table>	Codice	Descrizione	Qtà	UM	GN1326A1	GUARNIZIONE RESISTENZA 71X19 G6.25	1	PZ	RS0011A0	RESISTENZA CIRCOLARE 1465W 220-230	1	PZ	VI1220A1	VITE AUTOFILETTA NTE 4.2X11 TCS+ MARUTE	3	PZ	VM1794A0	FASCETTA 250X4.8 PA66 NERA	2	PZ	VM2103A0	PIASTRINA FERMAFASCE TTA	2	PZ
Codice	Descrizione	Qtà	UM																							
GN1326A1	GUARNIZIONE RESISTENZA 71X19 G6.25	1	PZ																							
RS0011A0	RESISTENZA CIRCOLARE 1465W 220-230	1	PZ																							
VI1220A1	VITE AUTOFILETTA NTE 4.2X11 TCS+ MARUTE	3	PZ																							
VM1794A0	FASCETTA 250X4.8 PA66 NERA	2	PZ																							
VM2103A0	PIASTRINA FERMAFASCE TTA	2	PZ																							
KRS0010A	KIT RESISTENZA RS0010A	<table border="1"> <thead> <tr> <th>Codice</th> <th>Descrizione</th> <th>Qtà</th> <th>UM</th> </tr> </thead> <tbody> <tr> <td>GN1326A1</td> <td>GUARNIZIONE RESISTENZA 71X19 G6.25</td> <td>1</td> <td>PZ</td> </tr> <tr> <td>IP1075A1</td> <td>IMB POL 70X150X765 D=10 CON PRETAGLIO</td> <td>1</td> <td>PZ</td> </tr> <tr> <td>IP1080A1</td> <td>IMB POL 280X255X10 D=10</td> <td>5</td> <td>PZ</td> </tr> <tr> <td>RS0010A0</td> <td>RESISTENZA CIRCOLARE 2560W 220-230</td> <td>1</td> <td>PZ</td> </tr> <tr> <td>VI1220A1</td> <td>VITE AUTOFILETTA NTE 4.2X11 TCS+ MARUTE</td> <td>3</td> <td>PZ</td> </tr> </tbody> </table>	Codice	Descrizione	Qtà	UM	GN1326A1	GUARNIZIONE RESISTENZA 71X19 G6.25	1	PZ	IP1075A1	IMB POL 70X150X765 D=10 CON PRETAGLIO	1	PZ	IP1080A1	IMB POL 280X255X10 D=10	5	PZ	RS0010A0	RESISTENZA CIRCOLARE 2560W 220-230	1	PZ	VI1220A1	VITE AUTOFILETTA NTE 4.2X11 TCS+ MARUTE	3	PZ
Codice	Descrizione	Qtà	UM																							
GN1326A1	GUARNIZIONE RESISTENZA 71X19 G6.25	1	PZ																							
IP1075A1	IMB POL 70X150X765 D=10 CON PRETAGLIO	1	PZ																							
IP1080A1	IMB POL 280X255X10 D=10	5	PZ																							
RS0010A0	RESISTENZA CIRCOLARE 2560W 220-230	1	PZ																							
VI1220A1	VITE AUTOFILETTA NTE 4.2X11 TCS+ MARUTE	3	PZ																							
KG1326A	KIT 5 PZ GUARNIZIONE RESISTENZA	<table border="1"> <thead> <tr> <th>Codice</th> <th>Descrizione</th> <th>Qtà</th> <th>UM</th> </tr> </thead> <tbody> <tr> <td>GN1326A1</td> <td>GUARNIZIONE RESISTENZA 71X19 G6.25</td> <td>5</td> <td>PZ</td> </tr> </tbody> </table>	Codice	Descrizione	Qtà	UM	GN1326A1	GUARNIZIONE RESISTENZA 71X19 G6.25	5	PZ																
Codice	Descrizione	Qtà	UM																							
GN1326A1	GUARNIZIONE RESISTENZA 71X19 G6.25	5	PZ																							

GN1326A1

COMPONENTE			RICAMBIO																										
Codice	Descrizione	Immagine	Codice	Descrizione	Lista componenti																								
RS1274A	RESISTENZA PIANA 100W 60V 1 SPIRA		KRS1274A	KIT RESISTENZA DI FRENATA 100W	<table border="1"> <thead> <tr> <th>Codice</th> <th>Descrizione</th> <th>Qtà</th> <th>UM</th> </tr> </thead> <tbody> <tr> <td>GN1326A1</td> <td>GUARNIZIONE RESISTENZA 71X19 G6.25</td> <td>1</td> <td>PZ</td> </tr> <tr> <td>RS1274A0</td> <td>RESISTENZA PIANA 100W 60V 1 SPIRA</td> <td>1</td> <td>PZ</td> </tr> <tr> <td>SL1045A0</td> <td>SILICONE ANTRACITE S53 80 ML</td> <td>1</td> <td>PZ</td> </tr> <tr> <td>VI1220A1</td> <td>VITE AUTOFILETTA NTE 4.2X11 TCS+ MARUTE</td> <td>2</td> <td>PZ</td> </tr> </tbody> </table>	Codice	Descrizione	Qtà	UM	GN1326A1	GUARNIZIONE RESISTENZA 71X19 G6.25	1	PZ	RS1274A0	RESISTENZA PIANA 100W 60V 1 SPIRA	1	PZ	SL1045A0	SILICONE ANTRACITE S53 80 ML	1	PZ	VI1220A1	VITE AUTOFILETTA NTE 4.2X11 TCS+ MARUTE	2	PZ				
Codice	Descrizione	Qtà	UM																										
GN1326A1	GUARNIZIONE RESISTENZA 71X19 G6.25	1	PZ																										
RS1274A0	RESISTENZA PIANA 100W 60V 1 SPIRA	1	PZ																										
SL1045A0	SILICONE ANTRACITE S53 80 ML	1	PZ																										
VI1220A1	VITE AUTOFILETTA NTE 4.2X11 TCS+ MARUTE	2	PZ																										
GN1285A	GUARNIZIONE SONDA DI TEMPERATURA NTC		KTR1106A	KIT SONDA TEMP. CAMERA L2000 S.5-5	<table border="1"> <thead> <tr> <th>Codice</th> <th>Descrizione</th> <th>Qtà</th> <th>UM</th> </tr> </thead> <tbody> <tr> <td>GN1285A0</td> <td>GUARNIZIONE SONDA DI TEMPERATUR A NTC</td> <td>1</td> <td>PZ</td> </tr> <tr> <td>SL1045A0</td> <td>SILICONE ANTRACITE S53 80 ML</td> <td>1</td> <td>PZ</td> </tr> <tr> <td>TR1106A3</td> <td>SONDA TEMPERATUR A PT100 L2000</td> <td>1</td> <td>PZ</td> </tr> <tr> <td>VI1220A1</td> <td>VITE AUTOFILETTA NTE 4.2X11 TCS+ MARUTE</td> <td>2</td> <td>PZ</td> </tr> <tr> <td>VM1465A0</td> <td>COPERCHIO SONDA TEMPERATUR A CHEFTOP</td> <td>1</td> <td>PZ</td> </tr> </tbody> </table>	Codice	Descrizione	Qtà	UM	GN1285A0	GUARNIZIONE SONDA DI TEMPERATUR A NTC	1	PZ	SL1045A0	SILICONE ANTRACITE S53 80 ML	1	PZ	TR1106A3	SONDA TEMPERATUR A PT100 L2000	1	PZ	VI1220A1	VITE AUTOFILETTA NTE 4.2X11 TCS+ MARUTE	2	PZ	VM1465A0	COPERCHIO SONDA TEMPERATUR A CHEFTOP	1	PZ
Codice	Descrizione	Qtà	UM																										
GN1285A0	GUARNIZIONE SONDA DI TEMPERATUR A NTC	1	PZ																										
SL1045A0	SILICONE ANTRACITE S53 80 ML	1	PZ																										
TR1106A3	SONDA TEMPERATUR A PT100 L2000	1	PZ																										
VI1220A1	VITE AUTOFILETTA NTE 4.2X11 TCS+ MARUTE	2	PZ																										
VM1465A0	COPERCHIO SONDA TEMPERATUR A CHEFTOP	1	PZ																										
			KTR1105A	KIT SONDA TEMPERATURA PT100 L1000	<table border="1"> <thead> <tr> <th>Codice</th> <th>Descrizione</th> <th>Qtà</th> <th>UM</th> </tr> </thead> <tbody> <tr> <td>GN1120A0</td> <td>GUARNIZIONE SONDA DI TEMPERATUR A NTC</td> <td>1</td> <td>PZ</td> </tr> <tr> <td>GN1285A0</td> <td>GUARNIZIONE SONDA DI TEMPERATUR A NTC</td> <td>1</td> <td>PZ</td> </tr> <tr> <td>SL1045A0</td> <td>SILICONE ANTRACITE S53 80 ML</td> <td>1</td> <td>PZ</td> </tr> <tr> <td>TR1105A3</td> <td>SONDA TEMPERATUR A PT100 L1000</td> <td>1</td> <td>PZ</td> </tr> <tr> <td>TR1105A4</td> <td>SONDA TEMPERATUR A PT100 L1000</td> <td>1</td> <td>PZ</td> </tr> </tbody> </table>	Codice	Descrizione	Qtà	UM	GN1120A0	GUARNIZIONE SONDA DI TEMPERATUR A NTC	1	PZ	GN1285A0	GUARNIZIONE SONDA DI TEMPERATUR A NTC	1	PZ	SL1045A0	SILICONE ANTRACITE S53 80 ML	1	PZ	TR1105A3	SONDA TEMPERATUR A PT100 L1000	1	PZ	TR1105A4	SONDA TEMPERATUR A PT100 L1000	1	PZ
Codice	Descrizione	Qtà	UM																										
GN1120A0	GUARNIZIONE SONDA DI TEMPERATUR A NTC	1	PZ																										
GN1285A0	GUARNIZIONE SONDA DI TEMPERATUR A NTC	1	PZ																										
SL1045A0	SILICONE ANTRACITE S53 80 ML	1	PZ																										
TR1105A3	SONDA TEMPERATUR A PT100 L1000	1	PZ																										
TR1105A4	SONDA TEMPERATUR A PT100 L1000	1	PZ																										

COMPONENTE			RICAMBIO																											
Codice	Descrizione	Immagine	Codice	Descrizione	Lista componenti																									
GN1285A	GUARNIZIONE SONDA DI TEMPERATURA NTC		KTR1105A	KIT SONDA TEMPERATURA PT100 L1000	<table border="1"> <thead> <tr> <th>Codice</th> <th>Descrizione</th> <th>Qtà</th> <th>UM</th> </tr> </thead> <tbody> <tr> <td>VI1220A1</td> <td>VITE AUTOFIILETTA NTE 4.2X11 TCS+ MARUTE</td> <td>2</td> <td>PZ</td> </tr> <tr> <td>VM1465A0</td> <td>COPERCHIO SONDA TEMPERATUR A CHEFTOP</td> <td>1</td> <td>PZ</td> </tr> </tbody> </table>	Codice	Descrizione	Qtà	UM	VI1220A1	VITE AUTOFIILETTA NTE 4.2X11 TCS+ MARUTE	2	PZ	VM1465A0	COPERCHIO SONDA TEMPERATUR A CHEFTOP	1	PZ													
			Codice	Descrizione	Qtà	UM																								
			VI1220A1	VITE AUTOFIILETTA NTE 4.2X11 TCS+ MARUTE	2	PZ																								
VM1465A0	COPERCHIO SONDA TEMPERATUR A CHEFTOP	1	PZ																											
KTR1096A	KIT SONDA TEMPERATURA NTC 150 L=1500	<table border="1"> <thead> <tr> <th>Codice</th> <th>Descrizione</th> <th>Qtà</th> <th>UM</th> </tr> </thead> <tbody> <tr> <td>GN1120A0</td> <td>GUARNIZIONE SONDA DI TEMPERATUR A NTC</td> <td>1</td> <td>PZ</td> </tr> <tr> <td>GN1285A0</td> <td>GUARNIZIONE SONDA DI TEMPERATUR A NTC</td> <td>2</td> <td>PZ</td> </tr> <tr> <td>SL1045A0</td> <td>SILICONE ANTRACITE S53 80 ML</td> <td>1</td> <td>PZ</td> </tr> <tr> <td>TR1096A0</td> <td>SONDA TEMPERATUR A NTC 150 L=1500</td> <td>1</td> <td>PZ</td> </tr> <tr> <td>VI1220A1</td> <td>VITE AUTOFIILETTA NTE 4.2X11 TCS+ MARUTE</td> <td>2</td> <td>PZ</td> </tr> <tr> <td>VM1465A0</td> <td>COPERCHIO SONDA TEMPERATUR A CHEFTOP</td> <td>1</td> <td>PZ</td> </tr> </tbody> </table>	Codice	Descrizione	Qtà	UM	GN1120A0	GUARNIZIONE SONDA DI TEMPERATUR A NTC	1	PZ	GN1285A0	GUARNIZIONE SONDA DI TEMPERATUR A NTC	2	PZ	SL1045A0	SILICONE ANTRACITE S53 80 ML	1	PZ	TR1096A0	SONDA TEMPERATUR A NTC 150 L=1500	1	PZ	VI1220A1	VITE AUTOFIILETTA NTE 4.2X11 TCS+ MARUTE	2	PZ	VM1465A0	COPERCHIO SONDA TEMPERATUR A CHEFTOP	1	PZ
Codice	Descrizione	Qtà	UM																											
GN1120A0	GUARNIZIONE SONDA DI TEMPERATUR A NTC	1	PZ																											
GN1285A0	GUARNIZIONE SONDA DI TEMPERATUR A NTC	2	PZ																											
SL1045A0	SILICONE ANTRACITE S53 80 ML	1	PZ																											
TR1096A0	SONDA TEMPERATUR A NTC 150 L=1500	1	PZ																											
VI1220A1	VITE AUTOFIILETTA NTE 4.2X11 TCS+ MARUTE	2	PZ																											
VM1465A0	COPERCHIO SONDA TEMPERATUR A CHEFTOP	1	PZ																											
KTR1095A	KIT SONDA TEMPERATURA NTC 150 L=1050	<table border="1"> <thead> <tr> <th>Codice</th> <th>Descrizione</th> <th>Qtà</th> <th>UM</th> </tr> </thead> <tbody> <tr> <td>GN1120A0</td> <td>GUARNIZIONE SONDA DI TEMPERATUR A NTC</td> <td>1</td> <td>PZ</td> </tr> <tr> <td>GN1285A0</td> <td>GUARNIZIONE SONDA DI TEMPERATUR A NTC</td> <td>1</td> <td>PZ</td> </tr> <tr> <td>SL1045A0</td> <td>SILICONE ANTRACITE S53 80 ML</td> <td>1</td> <td>PZ</td> </tr> <tr> <td>TR1095A0</td> <td>SONDA TEMPERATUR A NTC 150 L=1050</td> <td>1</td> <td>PZ</td> </tr> <tr> <td>VI1220A1</td> <td>VITE AUTOFIILETTA NTE 4.2X11 TCS+ MARUTE</td> <td>2</td> <td>PZ</td> </tr> <tr> <td>VM1465A0</td> <td>COPERCHIO SONDA TEMPERATUR A CHEFTOP</td> <td>1</td> <td>PZ</td> </tr> </tbody> </table>	Codice	Descrizione	Qtà	UM	GN1120A0	GUARNIZIONE SONDA DI TEMPERATUR A NTC	1	PZ	GN1285A0	GUARNIZIONE SONDA DI TEMPERATUR A NTC	1	PZ	SL1045A0	SILICONE ANTRACITE S53 80 ML	1	PZ	TR1095A0	SONDA TEMPERATUR A NTC 150 L=1050	1	PZ	VI1220A1	VITE AUTOFIILETTA NTE 4.2X11 TCS+ MARUTE	2	PZ	VM1465A0	COPERCHIO SONDA TEMPERATUR A CHEFTOP	1	PZ
Codice	Descrizione	Qtà	UM																											
GN1120A0	GUARNIZIONE SONDA DI TEMPERATUR A NTC	1	PZ																											
GN1285A0	GUARNIZIONE SONDA DI TEMPERATUR A NTC	1	PZ																											
SL1045A0	SILICONE ANTRACITE S53 80 ML	1	PZ																											
TR1095A0	SONDA TEMPERATUR A NTC 150 L=1050	1	PZ																											
VI1220A1	VITE AUTOFIILETTA NTE 4.2X11 TCS+ MARUTE	2	PZ																											
VM1465A0	COPERCHIO SONDA TEMPERATUR A CHEFTOP	1	PZ																											

COMPONENTE			RICAMBIO																														
Codice	Descrizione	Immagine	Codice	Descrizione	Lista componenti																												
GN1285A	GUARNIZIONE SONDA DI TEMPERATURA NTC		KTR1002A	KIT SONDA TEMPERATURA UL PT100 L1000	<table border="1"> <thead> <tr> <th>Codice</th> <th>Descrizione</th> <th>Qtà</th> <th>UM</th> </tr> </thead> <tbody> <tr> <td>GN1285A0</td> <td>GUARNIZIONE SONDA DI TEMPERATUR A NTC</td> <td>2</td> <td>PZ</td> </tr> <tr> <td>SL1045A0</td> <td>SILICONE ANTRACITE S53 80 ML</td> <td>1</td> <td>PZ</td> </tr> <tr> <td>TR1002A0</td> <td>SONDA TEMPERATUR A UL PT100 L1000</td> <td>1</td> <td>PZ</td> </tr> <tr> <td>VI1220A1</td> <td>VITE AUTOFILETTA NTE 4.2X11 TCS+ MARUTE</td> <td>2</td> <td>PZ</td> </tr> <tr> <td>VM1465A0</td> <td>COPERCHIO SONDA TEMPERATUR A CHEFTOP</td> <td>1</td> <td>PZ</td> </tr> </tbody> </table>	Codice	Descrizione	Qtà	UM	GN1285A0	GUARNIZIONE SONDA DI TEMPERATUR A NTC	2	PZ	SL1045A0	SILICONE ANTRACITE S53 80 ML	1	PZ	TR1002A0	SONDA TEMPERATUR A UL PT100 L1000	1	PZ	VI1220A1	VITE AUTOFILETTA NTE 4.2X11 TCS+ MARUTE	2	PZ	VM1465A0	COPERCHIO SONDA TEMPERATUR A CHEFTOP	1	PZ				
					Codice	Descrizione	Qtà	UM																									
GN1285A0	GUARNIZIONE SONDA DI TEMPERATUR A NTC	2	PZ																														
SL1045A0	SILICONE ANTRACITE S53 80 ML	1	PZ																														
TR1002A0	SONDA TEMPERATUR A UL PT100 L1000	1	PZ																														
VI1220A1	VITE AUTOFILETTA NTE 4.2X11 TCS+ MARUTE	2	PZ																														
VM1465A0	COPERCHIO SONDA TEMPERATUR A CHEFTOP	1	PZ																														
<table border="1"> <thead> <tr> <th>Codice</th> <th>Descrizione</th> <th>Qtà</th> <th>UM</th> </tr> </thead> <tbody> <tr> <td>GN1285A0</td> <td>GUARNIZIONE SONDA DI TEMPERATUR A NTC</td> <td>1</td> <td>PZ</td> </tr> <tr> <td>SL1045A0</td> <td>SILICONE ANTRACITE S53 80 ML</td> <td>1</td> <td>PZ</td> </tr> <tr> <td>TR1106B0</td> <td>SONDA TEMPERATUR A PT100 L 200</td> <td>1</td> <td>PZ</td> </tr> <tr> <td>VI1220A1</td> <td>VITE AUTOFILETTA NTE 4.2X11 TCS+ MARUTE</td> <td>2</td> <td>PZ</td> </tr> <tr> <td>VM1464A0</td> <td>COPERCHIO SONDA TEMPERATUR A CT BT CON PA</td> <td>1</td> <td>PZ</td> </tr> <tr> <td>VM1465A0</td> <td>COPERCHIO SONDA TEMPERATUR A CHEFTOP</td> <td>1</td> <td>PZ</td> </tr> </tbody> </table>	Codice	Descrizione	Qtà	UM	GN1285A0	GUARNIZIONE SONDA DI TEMPERATUR A NTC	1	PZ	SL1045A0	SILICONE ANTRACITE S53 80 ML	1	PZ	TR1106B0	SONDA TEMPERATUR A PT100 L 200	1	PZ	VI1220A1	VITE AUTOFILETTA NTE 4.2X11 TCS+ MARUTE	2	PZ	VM1464A0	COPERCHIO SONDA TEMPERATUR A CT BT CON PA	1	PZ	VM1465A0	COPERCHIO SONDA TEMPERATUR A CHEFTOP	1	PZ					
Codice	Descrizione	Qtà	UM																														
GN1285A0	GUARNIZIONE SONDA DI TEMPERATUR A NTC	1	PZ																														
SL1045A0	SILICONE ANTRACITE S53 80 ML	1	PZ																														
TR1106B0	SONDA TEMPERATUR A PT100 L 200	1	PZ																														
VI1220A1	VITE AUTOFILETTA NTE 4.2X11 TCS+ MARUTE	2	PZ																														
VM1464A0	COPERCHIO SONDA TEMPERATUR A CT BT CON PA	1	PZ																														
VM1465A0	COPERCHIO SONDA TEMPERATUR A CHEFTOP	1	PZ																														
TR1106A	SONDA TEMPERATURA PT100 L2000		KTR1106B	KIT SONDA TEMP. CAMERA L2000 MIND.MAPS	<table border="1"> <thead> <tr> <th>Codice</th> <th>Descrizione</th> <th>Qtà</th> <th>UM</th> </tr> </thead> <tbody> <tr> <td>GN1285A0</td> <td>GUARNIZIONE SONDA DI TEMPERATUR A NTC</td> <td>1</td> <td>PZ</td> </tr> <tr> <td>SL1045A0</td> <td>SILICONE ANTRACITE S53 80 ML</td> <td>1</td> <td>PZ</td> </tr> <tr> <td>TR1106B0</td> <td>SONDA TEMPERATUR A PT100 L 200</td> <td>1</td> <td>PZ</td> </tr> <tr> <td>VI1220A1</td> <td>VITE AUTOFILETTA NTE 4.2X11 TCS+ MARUTE</td> <td>2</td> <td>PZ</td> </tr> <tr> <td>VM1464A0</td> <td>COPERCHIO SONDA TEMPERATUR A CT BT CON PA</td> <td>1</td> <td>PZ</td> </tr> <tr> <td>VM1465A0</td> <td>COPERCHIO SONDA TEMPERATUR A CHEFTOP</td> <td>1</td> <td>PZ</td> </tr> </tbody> </table>	Codice	Descrizione	Qtà	UM	GN1285A0	GUARNIZIONE SONDA DI TEMPERATUR A NTC	1	PZ	SL1045A0	SILICONE ANTRACITE S53 80 ML	1	PZ	TR1106B0	SONDA TEMPERATUR A PT100 L 200	1	PZ	VI1220A1	VITE AUTOFILETTA NTE 4.2X11 TCS+ MARUTE	2	PZ	VM1464A0	COPERCHIO SONDA TEMPERATUR A CT BT CON PA	1	PZ	VM1465A0	COPERCHIO SONDA TEMPERATUR A CHEFTOP	1	PZ
			Codice	Descrizione	Qtà	UM																											
GN1285A0	GUARNIZIONE SONDA DI TEMPERATUR A NTC	1	PZ																														
SL1045A0	SILICONE ANTRACITE S53 80 ML	1	PZ																														
TR1106B0	SONDA TEMPERATUR A PT100 L 200	1	PZ																														
VI1220A1	VITE AUTOFILETTA NTE 4.2X11 TCS+ MARUTE	2	PZ																														
VM1464A0	COPERCHIO SONDA TEMPERATUR A CT BT CON PA	1	PZ																														
VM1465A0	COPERCHIO SONDA TEMPERATUR A CHEFTOP	1	PZ																														
<table border="1"> <thead> <tr> <th>Codice</th> <th>Descrizione</th> <th>Qtà</th> <th>UM</th> </tr> </thead> <tbody> <tr> <td>GN1285A0</td> <td>GUARNIZIONE SONDA DI TEMPERATUR A NTC</td> <td>1</td> <td>PZ</td> </tr> <tr> <td>SL1045A0</td> <td>SILICONE ANTRACITE S53 80 ML</td> <td>1</td> <td>PZ</td> </tr> </tbody> </table>	Codice	Descrizione	Qtà	UM	GN1285A0	GUARNIZIONE SONDA DI TEMPERATUR A NTC	1	PZ	SL1045A0	SILICONE ANTRACITE S53 80 ML	1	PZ																					
Codice	Descrizione	Qtà	UM																														
GN1285A0	GUARNIZIONE SONDA DI TEMPERATUR A NTC	1	PZ																														
SL1045A0	SILICONE ANTRACITE S53 80 ML	1	PZ																														
			KTR1106A	KIT SONDA TEMP. CAMERA L2000 S.5-5	<table border="1"> <thead> <tr> <th>Codice</th> <th>Descrizione</th> <th>Qtà</th> <th>UM</th> </tr> </thead> <tbody> <tr> <td>GN1285A0</td> <td>GUARNIZIONE SONDA DI TEMPERATUR A NTC</td> <td>1</td> <td>PZ</td> </tr> <tr> <td>SL1045A0</td> <td>SILICONE ANTRACITE S53 80 ML</td> <td>1</td> <td>PZ</td> </tr> </tbody> </table>	Codice	Descrizione	Qtà	UM	GN1285A0	GUARNIZIONE SONDA DI TEMPERATUR A NTC	1	PZ	SL1045A0	SILICONE ANTRACITE S53 80 ML	1	PZ																
Codice	Descrizione	Qtà	UM																														
GN1285A0	GUARNIZIONE SONDA DI TEMPERATUR A NTC	1	PZ																														
SL1045A0	SILICONE ANTRACITE S53 80 ML	1	PZ																														

COMPONENTE			RICAMBIO																														
Codice	Descrizione	Immagine	Codice	Descrizione	Lista componenti																												
TR1106A	SONDA TEMPERATURA PT100 L2000		KTR1106A	KIT SONDA TEMP. CAMERA L2000 S.5-5	<table border="1"> <thead> <tr> <th>Codice</th> <th>Descrizione</th> <th>Qtà</th> <th>UM</th> </tr> </thead> <tbody> <tr> <td>TR1106A3</td> <td>SONDA TEMPERATUR A PT100 L2000</td> <td>1</td> <td>PZ</td> </tr> <tr> <td>VI1220A1</td> <td>VITE AUTOFILETTA NTE 4.2X11 TCS+ MARUTE</td> <td>2</td> <td>PZ</td> </tr> <tr> <td>VM1465A0</td> <td>COPERCHIO SONDA TEMPERATUR A CHEFTOP</td> <td>1</td> <td>PZ</td> </tr> </tbody> </table>	Codice	Descrizione	Qtà	UM	TR1106A3	SONDA TEMPERATUR A PT100 L2000	1	PZ	VI1220A1	VITE AUTOFILETTA NTE 4.2X11 TCS+ MARUTE	2	PZ	VM1465A0	COPERCHIO SONDA TEMPERATUR A CHEFTOP	1	PZ												
Codice	Descrizione	Qtà	UM																														
TR1106A3	SONDA TEMPERATUR A PT100 L2000	1	PZ																														
VI1220A1	VITE AUTOFILETTA NTE 4.2X11 TCS+ MARUTE	2	PZ																														
VM1465A0	COPERCHIO SONDA TEMPERATUR A CHEFTOP	1	PZ																														
VM1464A	COPERCHIO SONDA TEMPERATURA CT BT CON PA		KVM1464A	KIT COPERCHIO SONDA TEMP CT BT VM1464A0	<table border="1"> <thead> <tr> <th>Codice</th> <th>Descrizione</th> <th>Qtà</th> <th>UM</th> </tr> </thead> <tbody> <tr> <td>VM1464A0</td> <td>COPERCHIO SONDA TEMPERATUR A CT BT CON PA</td> <td>1</td> <td>PZ</td> </tr> </tbody> </table>	Codice	Descrizione	Qtà	UM	VM1464A0	COPERCHIO SONDA TEMPERATUR A CT BT CON PA	1	PZ																				
Codice	Descrizione	Qtà	UM																														
VM1464A0	COPERCHIO SONDA TEMPERATUR A CT BT CON PA	1	PZ																														
TR1003A	SONDA TEMPERATURA UL PT100 L2000 USA		KTR1003B	KIT SONDA TEMP CAMERA L2000 MINDMAPS USA	<table border="1"> <thead> <tr> <th>Codice</th> <th>Descrizione</th> <th>Qtà</th> <th>UM</th> </tr> </thead> <tbody> <tr> <td>GN1285A0</td> <td>GUARNIZIONE SONDA DI TEMPERATUR A NTC</td> <td>1</td> <td>PZ</td> </tr> <tr> <td>SL1045A0</td> <td>SILICONE ANTRACITE S53 80 ML</td> <td>1</td> <td>PZ</td> </tr> <tr> <td>TR1003B0</td> <td>SONDA TEMPERATUR A UL PT100 L 2000 USA</td> <td>1</td> <td>PZ</td> </tr> <tr> <td>VI1220A1</td> <td>VITE AUTOFILETTA NTE 4.2X11 TCS+ MARUTE</td> <td>2</td> <td>PZ</td> </tr> <tr> <td>VM1464A0</td> <td>COPERCHIO SONDA TEMPERATUR A CT BT CON PA</td> <td>1</td> <td>PZ</td> </tr> <tr> <td>VM1465A0</td> <td>COPERCHIO SONDA TEMPERATUR A CHEFTOP</td> <td>1</td> <td>PZ</td> </tr> </tbody> </table>	Codice	Descrizione	Qtà	UM	GN1285A0	GUARNIZIONE SONDA DI TEMPERATUR A NTC	1	PZ	SL1045A0	SILICONE ANTRACITE S53 80 ML	1	PZ	TR1003B0	SONDA TEMPERATUR A UL PT100 L 2000 USA	1	PZ	VI1220A1	VITE AUTOFILETTA NTE 4.2X11 TCS+ MARUTE	2	PZ	VM1464A0	COPERCHIO SONDA TEMPERATUR A CT BT CON PA	1	PZ	VM1465A0	COPERCHIO SONDA TEMPERATUR A CHEFTOP	1	PZ
Codice	Descrizione	Qtà	UM																														
GN1285A0	GUARNIZIONE SONDA DI TEMPERATUR A NTC	1	PZ																														
SL1045A0	SILICONE ANTRACITE S53 80 ML	1	PZ																														
TR1003B0	SONDA TEMPERATUR A UL PT100 L 2000 USA	1	PZ																														
VI1220A1	VITE AUTOFILETTA NTE 4.2X11 TCS+ MARUTE	2	PZ																														
VM1464A0	COPERCHIO SONDA TEMPERATUR A CT BT CON PA	1	PZ																														
VM1465A0	COPERCHIO SONDA TEMPERATUR A CHEFTOP	1	PZ																														
			KTR1003A	KIT SONDA TEMP CAMERA L2000 S 5-5E USA	<table border="1"> <thead> <tr> <th>Codice</th> <th>Descrizione</th> <th>Qtà</th> <th>UM</th> </tr> </thead> <tbody> <tr> <td>GN1285A0</td> <td>GUARNIZIONE SONDA DI TEMPERATUR A NTC</td> <td>1</td> <td>PZ</td> </tr> </tbody> </table>	Codice	Descrizione	Qtà	UM	GN1285A0	GUARNIZIONE SONDA DI TEMPERATUR A NTC	1	PZ																				
Codice	Descrizione	Qtà	UM																														
GN1285A0	GUARNIZIONE SONDA DI TEMPERATUR A NTC	1	PZ																														



COMPONENTE			RICAMBIO																										
Codice	Descrizione	Immagine	Codice	Descrizione	Lista componenti																								
TR1003A	SONDA TEMPERATURA UL PT100 L2000 USA		KTR1003A	KIT SONDA TEMP CAMERA L2000 S 5-5E USA	<table border="1"> <thead> <tr> <th>Codice</th> <th>Descrizione</th> <th>Qtà</th> <th>UM</th> </tr> </thead> <tbody> <tr> <td>SL1045A0</td> <td>SILICONE ANTRACITE S53 80 ML</td> <td>1</td> <td>PZ</td> </tr> <tr> <td>TR1003A0</td> <td>SONDA TEMPERATUR A UL PT100 L2000 USA</td> <td>1</td> <td>PZ</td> </tr> <tr> <td>VI1220A1</td> <td>VITE AUTOFILETTA NTE 4.2X11 TCS+ MARUTE</td> <td>2</td> <td>PZ</td> </tr> <tr> <td>VM1465A0</td> <td>COPERCHIO SONDA TEMPERATUR A CHEFTOP</td> <td>1</td> <td>PZ</td> </tr> </tbody> </table>	Codice	Descrizione	Qtà	UM	SL1045A0	SILICONE ANTRACITE S53 80 ML	1	PZ	TR1003A0	SONDA TEMPERATUR A UL PT100 L2000 USA	1	PZ	VI1220A1	VITE AUTOFILETTA NTE 4.2X11 TCS+ MARUTE	2	PZ	VM1465A0	COPERCHIO SONDA TEMPERATUR A CHEFTOP	1	PZ				
Codice	Descrizione	Qtà	UM																										
SL1045A0	SILICONE ANTRACITE S53 80 ML	1	PZ																										
TR1003A0	SONDA TEMPERATUR A UL PT100 L2000 USA	1	PZ																										
VI1220A1	VITE AUTOFILETTA NTE 4.2X11 TCS+ MARUTE	2	PZ																										
VM1465A0	COPERCHIO SONDA TEMPERATUR A CHEFTOP	1	PZ																										
GN1531A	GUARNIZIONE TENUTA INGRESSO BULBO		KTR1136A	KIT TERMOSTATO SICUREZZA 330°C	<table border="1"> <thead> <tr> <th>Codice</th> <th>Descrizione</th> <th>Qtà</th> <th>UM</th> </tr> </thead> <tbody> <tr> <td>0H7030A0</td> <td>COPERCHIO INGRESSO BULBO</td> <td>1</td> <td>PZ</td> </tr> <tr> <td>GN1531A0</td> <td>GUARNIZIONE TENUTA INGRESSO BULBO</td> <td>1</td> <td>PZ</td> </tr> <tr> <td>SL1045A0</td> <td>SILICONE ANTRACITE S53 80 ML</td> <td>1</td> <td>PZ</td> </tr> <tr> <td>TR1136A0</td> <td>TERMOSTATO SIC. UNIP. 330°C</td> <td>1</td> <td>PZ</td> </tr> <tr> <td>VI1220A1</td> <td>VITE AUTOFILETTA NTE 4.2X11 TCS+ MARUTE</td> <td>3</td> <td>PZ</td> </tr> </tbody> </table>	Codice	Descrizione	Qtà	UM	0H7030A0	COPERCHIO INGRESSO BULBO	1	PZ	GN1531A0	GUARNIZIONE TENUTA INGRESSO BULBO	1	PZ	SL1045A0	SILICONE ANTRACITE S53 80 ML	1	PZ	TR1136A0	TERMOSTATO SIC. UNIP. 330°C	1	PZ	VI1220A1	VITE AUTOFILETTA NTE 4.2X11 TCS+ MARUTE	3	PZ
Codice	Descrizione	Qtà	UM																										
0H7030A0	COPERCHIO INGRESSO BULBO	1	PZ																										
GN1531A0	GUARNIZIONE TENUTA INGRESSO BULBO	1	PZ																										
SL1045A0	SILICONE ANTRACITE S53 80 ML	1	PZ																										
TR1136A0	TERMOSTATO SIC. UNIP. 330°C	1	PZ																										
VI1220A1	VITE AUTOFILETTA NTE 4.2X11 TCS+ MARUTE	3	PZ																										
0H7030A	COPERCHIO INGRESSO BULBO		K0H7030A	KIT COPERCHIO INGRESSO BULBO 1PZ	<table border="1"> <thead> <tr> <th>Codice</th> <th>Descrizione</th> <th>Qtà</th> <th>UM</th> </tr> </thead> <tbody> <tr> <td>0H7030A0</td> <td>COPERCHIO INGRESSO BULBO</td> <td>1</td> <td>PZ</td> </tr> </tbody> </table>	Codice	Descrizione	Qtà	UM	0H7030A0	COPERCHIO INGRESSO BULBO	1	PZ																
Codice	Descrizione	Qtà	UM																										
0H7030A0	COPERCHIO INGRESSO BULBO	1	PZ																										
0H2551A	TAPPO PER TUBO DI SCARICO LIQUIDI INOX C		0H2551A0	TAPPO PER TUBO DI SCARICO LIQUIDI INOX C																									

COMPONENTE			RICAMBIO														
<i>Codice</i>	<i>Descrizione</i>	<i>Immagine</i>	<i>Codice</i>	<i>Descrizione</i>	<i>Lista componenti</i>												
0H7320A	SUPPORTO TUBO VENTURI MM		0H7320A0	SUPPORTO TUBO VENTURI MM													
VM1820A	NOTTOLINO M6 CROMATO FISS. SUPPORTI		KVM1820A	KIT 10 NOTTOLINI S.	<table border="1"> <thead> <tr> <th>Codice</th> <th>Descrizione</th> <th>Qtà</th> <th>UM</th> </tr> </thead> <tbody> <tr> <td>VM1820A0</td> <td>NOTTOLINO M6 CROMATO FISS. SUPPORTI</td> <td>10</td> <td>PZ</td> </tr> </tbody> </table>	Codice	Descrizione	Qtà	UM	VM1820A0	NOTTOLINO M6 CROMATO FISS. SUPPORTI	10	PZ				
Codice	Descrizione	Qtà	UM														
VM1820A0	NOTTOLINO M6 CROMATO FISS. SUPPORTI	10	PZ														
0G1577A	CARTER COMPLETO XEVC-2011-E																
TB2917A	ASM TUBO UMIDITA 5 VIE XEVC-2011-E		TB2917A0	ASM TUBO UMIDITA 5 VIE XEVC-2011-E													
VM2251A	DISTRIBUTORE UMIDITA SUPERIOR		KVM2251A	KIT DISTRIBUTORI UMIDITA'	<table border="1"> <thead> <tr> <th>Codice</th> <th>Descrizione</th> <th>Qtà</th> <th>UM</th> </tr> </thead> <tbody> <tr> <td>VM2251A0</td> <td>DISTRIBUTORE UMIDITA SUPERIORE</td> <td>1</td> <td>PZ</td> </tr> <tr> <td>VM2252A0</td> <td>DISTRIBUTORE UMIDITA INFERIORE</td> <td>1</td> <td>PZ</td> </tr> </tbody> </table>	Codice	Descrizione	Qtà	UM	VM2251A0	DISTRIBUTORE UMIDITA SUPERIORE	1	PZ	VM2252A0	DISTRIBUTORE UMIDITA INFERIORE	1	PZ
Codice	Descrizione	Qtà	UM														
VM2251A0	DISTRIBUTORE UMIDITA SUPERIORE	1	PZ														
VM2252A0	DISTRIBUTORE UMIDITA INFERIORE	1	PZ														

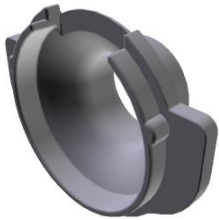

COMPONENTE			RICAMBIO														
Codice	Descrizione	Immagine	Codice	Descrizione	Lista componenti												
VM2252A	DISTRIBUTORE UMIDITA INFERIORE		KVM2252A	KIT DISTRIBUTORE UMIDITA' INFERIOR	<table border="1"> <thead> <tr> <th>Codice</th> <th>Descrizione</th> <th>Qtà</th> <th>UM</th> </tr> </thead> <tbody> <tr> <td>VM2252A0</td> <td>DISTRIBUTOR E UMIDITA INFERIORE</td> <td>1</td> <td>PZ</td> </tr> </tbody> </table>	Codice	Descrizione	Qtà	UM	VM2252A0	DISTRIBUTOR E UMIDITA INFERIORE	1	PZ				
			Codice	Descrizione	Qtà	UM											
VM2252A0	DISTRIBUTOR E UMIDITA INFERIORE	1	PZ														
KVM2251A	KIT DISTRIBUTORI UMIDITA'	<table border="1"> <thead> <tr> <th>Codice</th> <th>Descrizione</th> <th>Qtà</th> <th>UM</th> </tr> </thead> <tbody> <tr> <td>VM2251A0</td> <td>DISTRIBUTOR E UMIDITA SUPERIORE</td> <td>1</td> <td>PZ</td> </tr> <tr> <td>VM2252A0</td> <td>DISTRIBUTOR E UMIDITA INFERIORE</td> <td>1</td> <td>PZ</td> </tr> </tbody> </table>	Codice	Descrizione	Qtà	UM	VM2251A0	DISTRIBUTOR E UMIDITA SUPERIORE	1	PZ	VM2252A0	DISTRIBUTOR E UMIDITA INFERIORE	1	PZ			
Codice	Descrizione	Qtà	UM														
VM2251A0	DISTRIBUTOR E UMIDITA SUPERIORE	1	PZ														
VM2252A0	DISTRIBUTOR E UMIDITA INFERIORE	1	PZ														
VM2251A	DISTRIBUTORE UMIDITA SUPERIOR		KVM2251A	KIT DISTRIBUTORI UMIDITA'	<table border="1"> <thead> <tr> <th>Codice</th> <th>Descrizione</th> <th>Qtà</th> <th>UM</th> </tr> </thead> <tbody> <tr> <td>VM2251A0</td> <td>DISTRIBUTOR E UMIDITA SUPERIORE</td> <td>1</td> <td>PZ</td> </tr> <tr> <td>VM2252A0</td> <td>DISTRIBUTOR E UMIDITA INFERIORE</td> <td>1</td> <td>PZ</td> </tr> </tbody> </table>	Codice	Descrizione	Qtà	UM	VM2251A0	DISTRIBUTOR E UMIDITA SUPERIORE	1	PZ	VM2252A0	DISTRIBUTOR E UMIDITA INFERIORE	1	PZ
Codice	Descrizione	Qtà	UM														
VM2251A0	DISTRIBUTOR E UMIDITA SUPERIORE	1	PZ														
VM2252A0	DISTRIBUTOR E UMIDITA INFERIORE	1	PZ														
VM2252A	DISTRIBUTORE UMIDITA INFERIORE		KVM2252A	KIT DISTRIBUTORE UMIDITA' INFERIOR	<table border="1"> <thead> <tr> <th>Codice</th> <th>Descrizione</th> <th>Qtà</th> <th>UM</th> </tr> </thead> <tbody> <tr> <td>VM2252A0</td> <td>DISTRIBUTOR E UMIDITA INFERIORE</td> <td>1</td> <td>PZ</td> </tr> </tbody> </table>	Codice	Descrizione	Qtà	UM	VM2252A0	DISTRIBUTOR E UMIDITA INFERIORE	1	PZ				
			Codice	Descrizione	Qtà	UM											
VM2252A0	DISTRIBUTOR E UMIDITA INFERIORE	1	PZ														
KVM2251A	KIT DISTRIBUTORI UMIDITA'	<table border="1"> <thead> <tr> <th>Codice</th> <th>Descrizione</th> <th>Qtà</th> <th>UM</th> </tr> </thead> <tbody> <tr> <td>VM2251A0</td> <td>DISTRIBUTOR E UMIDITA SUPERIORE</td> <td>1</td> <td>PZ</td> </tr> <tr> <td>VM2252A0</td> <td>DISTRIBUTOR E UMIDITA INFERIORE</td> <td>1</td> <td>PZ</td> </tr> </tbody> </table>	Codice	Descrizione	Qtà	UM	VM2251A0	DISTRIBUTOR E UMIDITA SUPERIORE	1	PZ	VM2252A0	DISTRIBUTOR E UMIDITA INFERIORE	1	PZ			
Codice	Descrizione	Qtà	UM														
VM2251A0	DISTRIBUTOR E UMIDITA SUPERIORE	1	PZ														
VM2252A0	DISTRIBUTOR E UMIDITA INFERIORE	1	PZ														
TB2918A	ASM TUBO UMIDITA 4 VIE XEVC-2011-E		TB2918A0	ASM TUBO UMIDITA 4 VIE XEVC-2011-E													

COMPONENTE			RICAMBIO														
Codice	Descrizione	Immagine	Codice	Descrizione	Lista componenti												
VM2251A	DISTRIBUTORE UMIDITA SUPERIOR		KVM2251A	KIT DISTRIBUTORI UMIDITA'	<table border="1"> <thead> <tr> <th>Codice</th> <th>Descrizione</th> <th>Qtà</th> <th>UM</th> </tr> </thead> <tbody> <tr> <td>VM2251A0</td> <td>DISTRIBUTOR E UMIDITA SUPERIORE</td> <td>1</td> <td>PZ</td> </tr> <tr> <td>VM2252A0</td> <td>DISTRIBUTOR E UMIDITA INFERIORE</td> <td>1</td> <td>PZ</td> </tr> </tbody> </table>	Codice	Descrizione	Qtà	UM	VM2251A0	DISTRIBUTOR E UMIDITA SUPERIORE	1	PZ	VM2252A0	DISTRIBUTOR E UMIDITA INFERIORE	1	PZ
Codice	Descrizione	Qtà	UM														
VM2251A0	DISTRIBUTOR E UMIDITA SUPERIORE	1	PZ														
VM2252A0	DISTRIBUTOR E UMIDITA INFERIORE	1	PZ														
VM2252A	DISTRIBUTORE UMIDITA INFERIORE		KVM2252A	KIT DISTRIBUTORE UMIDITA' INFERIOR	<table border="1"> <thead> <tr> <th>Codice</th> <th>Descrizione</th> <th>Qtà</th> <th>UM</th> </tr> </thead> <tbody> <tr> <td>VM2252A0</td> <td>DISTRIBUTOR E UMIDITA INFERIORE</td> <td>1</td> <td>PZ</td> </tr> </tbody> </table>	Codice	Descrizione	Qtà	UM	VM2252A0	DISTRIBUTOR E UMIDITA INFERIORE	1	PZ				
Codice	Descrizione	Qtà	UM														
VM2252A0	DISTRIBUTOR E UMIDITA INFERIORE	1	PZ														
			KVM2251A	KIT DISTRIBUTORI UMIDITA'	<table border="1"> <thead> <tr> <th>Codice</th> <th>Descrizione</th> <th>Qtà</th> <th>UM</th> </tr> </thead> <tbody> <tr> <td>VM2251A0</td> <td>DISTRIBUTOR E UMIDITA SUPERIORE</td> <td>1</td> <td>PZ</td> </tr> <tr> <td>VM2252A0</td> <td>DISTRIBUTOR E UMIDITA INFERIORE</td> <td>1</td> <td>PZ</td> </tr> </tbody> </table>	Codice	Descrizione	Qtà	UM	VM2251A0	DISTRIBUTOR E UMIDITA SUPERIORE	1	PZ	VM2252A0	DISTRIBUTOR E UMIDITA INFERIORE	1	PZ
Codice	Descrizione	Qtà	UM														
VM2251A0	DISTRIBUTOR E UMIDITA SUPERIORE	1	PZ														
VM2252A0	DISTRIBUTOR E UMIDITA INFERIORE	1	PZ														
TB2919A	ASM TUBO UMIDITA 3 VIE XEVC-2011-E		TB2919A0	ASM TUBO UMIDITA 3 VIE XEVC-2011-E													
VM2251A	DISTRIBUTORE UMIDITA SUPERIOR		KVM2251A	KIT DISTRIBUTORI UMIDITA'	<table border="1"> <thead> <tr> <th>Codice</th> <th>Descrizione</th> <th>Qtà</th> <th>UM</th> </tr> </thead> <tbody> <tr> <td>VM2251A0</td> <td>DISTRIBUTOR E UMIDITA SUPERIORE</td> <td>1</td> <td>PZ</td> </tr> <tr> <td>VM2252A0</td> <td>DISTRIBUTOR E UMIDITA INFERIORE</td> <td>1</td> <td>PZ</td> </tr> </tbody> </table>	Codice	Descrizione	Qtà	UM	VM2251A0	DISTRIBUTOR E UMIDITA SUPERIORE	1	PZ	VM2252A0	DISTRIBUTOR E UMIDITA INFERIORE	1	PZ
Codice	Descrizione	Qtà	UM														
VM2251A0	DISTRIBUTOR E UMIDITA SUPERIORE	1	PZ														
VM2252A0	DISTRIBUTOR E UMIDITA INFERIORE	1	PZ														
VM2252A	DISTRIBUTORE UMIDITA INFERIORE		KVM2252A	KIT DISTRIBUTORE UMIDITA' INFERIOR	<table border="1"> <thead> <tr> <th>Codice</th> <th>Descrizione</th> <th>Qtà</th> <th>UM</th> </tr> </thead> <tbody> <tr> <td>VM2252A0</td> <td>DISTRIBUTOR E UMIDITA INFERIORE</td> <td>1</td> <td>PZ</td> </tr> </tbody> </table>	Codice	Descrizione	Qtà	UM	VM2252A0	DISTRIBUTOR E UMIDITA INFERIORE	1	PZ				
Codice	Descrizione	Qtà	UM														
VM2252A0	DISTRIBUTOR E UMIDITA INFERIORE	1	PZ														
			KVM2251A	KIT DISTRIBUTORI UMIDITA'	<table border="1"> <thead> <tr> <th>Codice</th> <th>Descrizione</th> <th>Qtà</th> <th>UM</th> </tr> </thead> <tbody> <tr> <td>VM2251A0</td> <td>DISTRIBUTOR E UMIDITA SUPERIORE</td> <td>1</td> <td>PZ</td> </tr> <tr> <td>VM2252A0</td> <td>DISTRIBUTOR E UMIDITA INFERIORE</td> <td>1</td> <td>PZ</td> </tr> </tbody> </table>	Codice	Descrizione	Qtà	UM	VM2251A0	DISTRIBUTOR E UMIDITA SUPERIORE	1	PZ	VM2252A0	DISTRIBUTOR E UMIDITA INFERIORE	1	PZ
Codice	Descrizione	Qtà	UM														
VM2251A0	DISTRIBUTOR E UMIDITA SUPERIORE	1	PZ														
VM2252A0	DISTRIBUTOR E UMIDITA INFERIORE	1	PZ														



COMPONENTE			RICAMBIO														
Codice	Descrizione	Immagine	Codice	Descrizione	Lista componenti												
TB2920A	ASM TUBO UMIDITA 2 VIE XEVC-2011-E		TB2920A0	ASM TUBO UMIDITA 2 VIE XEVC-2011-E													
TB2921A	TUBO UMIDITA INFERIORE XEVC-2011-E		TB2921A0	TUBO UMIDITA INFERIORE XEVC-2011-E													
VM2332A	BOCCOLA TUBI UMIDITA		KVM2332A	KIT BOCCOLA TUBI UMIDITA VM2332A0	<table border="1"> <thead> <tr> <th>Codice</th> <th>Descrizione</th> <th>Qta</th> <th>UM</th> </tr> </thead> <tbody> <tr> <td>VM2332A0</td> <td>BOCCOLA TUBI UMIDITA</td> <td>1</td> <td>PZ</td> </tr> </tbody> </table>	Codice	Descrizione	Qta	UM	VM2332A0	BOCCOLA TUBI UMIDITA	1	PZ				
Codice	Descrizione	Qta	UM														
VM2332A0	BOCCOLA TUBI UMIDITA	1	PZ														
VM2350A	SUPPORTO SONDA AL CUORE		KVM2350A	KIT SUPPORTO SONDA AL CUORE 1PZ	<table border="1"> <thead> <tr> <th>Codice</th> <th>Descrizione</th> <th>Qta</th> <th>UM</th> </tr> </thead> <tbody> <tr> <td>VI1220A1</td> <td>VITE AUTOFILETTA NTE 4.2X11 TCS+ MARUTE</td> <td>2</td> <td>PZ</td> </tr> <tr> <td>VM2350A0</td> <td>SUPPORTO SONDA AL CUORE</td> <td>1</td> <td>PZ</td> </tr> </tbody> </table>	Codice	Descrizione	Qta	UM	VI1220A1	VITE AUTOFILETTA NTE 4.2X11 TCS+ MARUTE	2	PZ	VM2350A0	SUPPORTO SONDA AL CUORE	1	PZ
Codice	Descrizione	Qta	UM														
VI1220A1	VITE AUTOFILETTA NTE 4.2X11 TCS+ MARUTE	2	PZ														
VM2350A0	SUPPORTO SONDA AL CUORE	1	PZ														
GN1085A	GUARNIZIONE RESISTENZA 141X24 G6.25		KG1085A	KIT GUARNIZIONE RESISTENZA GN1085A2	<table border="1"> <thead> <tr> <th>Codice</th> <th>Descrizione</th> <th>Qta</th> <th>UM</th> </tr> </thead> <tbody> <tr> <td>GN1085A2</td> <td>GUARNIZIONE RESISTENZA 141X24 G6.25</td> <td>1</td> <td>PZ</td> </tr> </tbody> </table>	Codice	Descrizione	Qta	UM	GN1085A2	GUARNIZIONE RESISTENZA 141X24 G6.25	1	PZ				
Codice	Descrizione	Qta	UM														
GN1085A2	GUARNIZIONE RESISTENZA 141X24 G6.25	1	PZ														



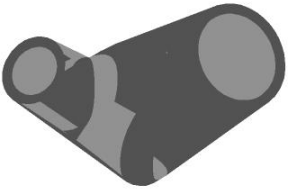

COMPONENTE			RICAMBIO																																										
Codice	Descrizione	Immagine	Codice	Descrizione	Lista componenti																																								
RS1205A	RES. CIRCOLARE 5.6KW 230V D230 6 SPIRE		KRS1205A	KIT RESISTENZA CIRCOLARE 5.6KW 6 SPIRE	<table border="1"> <thead> <tr> <th>Codice</th> <th>Descrizione</th> <th>Qtà</th> <th>UM</th> </tr> </thead> <tbody> <tr> <td>GN1085A2</td> <td>GUARNIZIONE RESISTENZA 141X24 G6.25</td> <td>1</td> <td>PZ</td> </tr> <tr> <td>RS1205A1</td> <td>RES. CIRCOLARE 5.6KW 230V D230 6 SPIRE</td> <td>1</td> <td>PZ</td> </tr> <tr> <td>SL1045A0</td> <td>SILICONE ANTRACITE S53 80 ML</td> <td>1</td> <td>PZ</td> </tr> <tr> <td>VI1032A0</td> <td>VITE M4X16 TCB+ INOX</td> <td>1</td> <td>PZ</td> </tr> <tr> <td>VI1075A0</td> <td>DADO M4 H=4 INOX UNI5587</td> <td>1</td> <td>PZ</td> </tr> <tr> <td>VI1220A1</td> <td>VITE AUTOFILETTA NTE 4.2X11 TCS+ MARUTE</td> <td>6</td> <td>PZ</td> </tr> <tr> <td>VI1511A0</td> <td>RONDELLA PIANA 4.2X12X1 INOX</td> <td>1</td> <td>PZ</td> </tr> <tr> <td>VM1794A0</td> <td>FASCETTA 250X4.8 PA66 NERA</td> <td>2</td> <td>PZ</td> </tr> <tr> <td>VM2103A0</td> <td>PIASTRINA FERMAFASCE TTA</td> <td>2</td> <td>PZ</td> </tr> </tbody> </table>	Codice	Descrizione	Qtà	UM	GN1085A2	GUARNIZIONE RESISTENZA 141X24 G6.25	1	PZ	RS1205A1	RES. CIRCOLARE 5.6KW 230V D230 6 SPIRE	1	PZ	SL1045A0	SILICONE ANTRACITE S53 80 ML	1	PZ	VI1032A0	VITE M4X16 TCB+ INOX	1	PZ	VI1075A0	DADO M4 H=4 INOX UNI5587	1	PZ	VI1220A1	VITE AUTOFILETTA NTE 4.2X11 TCS+ MARUTE	6	PZ	VI1511A0	RONDELLA PIANA 4.2X12X1 INOX	1	PZ	VM1794A0	FASCETTA 250X4.8 PA66 NERA	2	PZ	VM2103A0	PIASTRINA FERMAFASCE TTA	2	PZ
Codice	Descrizione	Qtà	UM																																										
GN1085A2	GUARNIZIONE RESISTENZA 141X24 G6.25	1	PZ																																										
RS1205A1	RES. CIRCOLARE 5.6KW 230V D230 6 SPIRE	1	PZ																																										
SL1045A0	SILICONE ANTRACITE S53 80 ML	1	PZ																																										
VI1032A0	VITE M4X16 TCB+ INOX	1	PZ																																										
VI1075A0	DADO M4 H=4 INOX UNI5587	1	PZ																																										
VI1220A1	VITE AUTOFILETTA NTE 4.2X11 TCS+ MARUTE	6	PZ																																										
VI1511A0	RONDELLA PIANA 4.2X12X1 INOX	1	PZ																																										
VM1794A0	FASCETTA 250X4.8 PA66 NERA	2	PZ																																										
VM2103A0	PIASTRINA FERMAFASCE TTA	2	PZ																																										
SN1016A	SONDA CUORE 100MM MONOPUNTO L2750		KSN1016A	KIT SONDA CUORE 100MM MONOPUNTO L2730	<table border="1"> <thead> <tr> <th>Codice</th> <th>Descrizione</th> <th>Qtà</th> <th>UM</th> </tr> </thead> <tbody> <tr> <td>0H7374A0</td> <td>LAMIERINO TAGLIO CAVO SONDA CUOR</td> <td>2</td> <td>PZ</td> </tr> <tr> <td>SN1016A0</td> <td>SONDA CUORE 100MM MONOPUNTO L2730</td> <td>1</td> <td>PZ</td> </tr> <tr> <td>SN1016A1</td> <td>SONDA CUORE 100MM MONOPUNTO L2750</td> <td>1</td> <td>PZ</td> </tr> </tbody> </table>	Codice	Descrizione	Qtà	UM	0H7374A0	LAMIERINO TAGLIO CAVO SONDA CUOR	2	PZ	SN1016A0	SONDA CUORE 100MM MONOPUNTO L2730	1	PZ	SN1016A1	SONDA CUORE 100MM MONOPUNTO L2750	1	PZ																								
Codice	Descrizione	Qtà	UM																																										
0H7374A0	LAMIERINO TAGLIO CAVO SONDA CUOR	2	PZ																																										
SN1016A0	SONDA CUORE 100MM MONOPUNTO L2730	1	PZ																																										
SN1016A1	SONDA CUORE 100MM MONOPUNTO L2750	1	PZ																																										
0H2730A	STAFFA ZINCATA SOSTEGNO MUFFOLA																																												

COMPONENTE			RICAMBIO										
Codice	Descrizione	Immagine	Codice	Descrizione	Lista componenti								
GN1544A	GUARNIZIONE INGRESSO ARIA		GN1544A0	GUARNIZIONE INGRESSO ARIA									
RC1055A	FASCETTA STRINGI TUBO Ø25-40 H12 INOX		KRC1055A	KIT 10 PZ FASCETTA STRINGI TUBO RC1055A0	<table border="1"> <thead> <tr> <th>Codice</th> <th>Descrizione</th> <th>Qtà</th> <th>UM</th> </tr> </thead> <tbody> <tr> <td>RC1055A0</td> <td>FASCETTA STRINGI TUBO Ø25-40 H12 INOX</td> <td>10</td> <td>PZ</td> </tr> </tbody> </table>	Codice	Descrizione	Qtà	UM	RC1055A0	FASCETTA STRINGI TUBO Ø25-40 H12 INOX	10	PZ
Codice	Descrizione	Qtà	UM										
RC1055A0	FASCETTA STRINGI TUBO Ø25-40 H12 INOX	10	PZ										
TB3020A	TB1520A-TUBO NERO EPDM L=275		TB3020A0	TB1520A-TUBO NERO EPDM L=275									
TB3021A	TB1520A-TUBO NERO EPDM L=448		TB3021A0	TB1520A-TUBO NERO EPDM L=448									
TB3022A	TB1520A-TUBO NERO EPDM L=140		TB3022A0	TB1520A-TUBO NERO EPDM L=140									

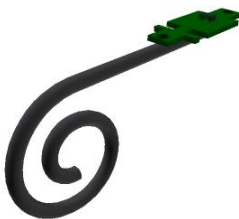
COMPONENTE			RICAMBIO																																																		
Codice	Descrizione	Immagine	Codice	Descrizione	Lista componenti																																																
TB3023A	TB1520A-TUBO NERO EPDM L=230		TB3023A0	TB1520A-TUBO NERO EPDM L=230																																																	
VM2377A	ASM VENTURI 220V 50/60 HZ		KVM2377A	KIT ASSIEME ATTUATORE VENTURI MM	<table border="1"> <thead> <tr> <th>Codice</th> <th>Descrizione</th> <th>Qtà</th> <th>UM</th> </tr> </thead> <tbody> <tr> <td>GN1556A0</td> <td>GUARNIZIONE VENTURI MM</td> <td>1</td> <td>PZ</td> </tr> <tr> <td>RC1378A0</td> <td>FASCETTA STRINGI TUBO ZINCATA</td> <td>3</td> <td>PZ</td> </tr> <tr> <td>TB1520A0</td> <td>TUBO D.INT=30 SP=4 GOMMA EPDM NERO</td> <td>0.170</td> <td>M</td> </tr> <tr> <td>VE1135A0</td> <td>ATTUATORE VENTURI 220V 50/60 HZ SERIE 2</td> <td>1</td> <td>PZ</td> </tr> <tr> <td>VI1032A0</td> <td>VITE M4X16 TCB+ INOX</td> <td>1</td> <td>PZ</td> </tr> <tr> <td>VI1220A1</td> <td>VITE AUTOFILETTA NTE 4.2X11 TCS+ MARUTE</td> <td>6</td> <td>PZ</td> </tr> <tr> <td>VM2345A0</td> <td>CORPO SUPERIORE VENTURI MM</td> <td>1</td> <td>PZ</td> </tr> <tr> <td>VM2346A0</td> <td>CORPO INFERIORE VENTURI MM</td> <td>1</td> <td>PZ</td> </tr> <tr> <td>VM2347A0</td> <td>COPERCHIETT O VENTURI MIND.MAPS</td> <td>1</td> <td>PZ</td> </tr> <tr> <td>VM2348A0</td> <td>DISTANZIALE PIATTELLO VENTURI</td> <td>1</td> <td>PZ</td> </tr> <tr> <td>VM2349A0</td> <td>BOCCOLA INFERIORE VENTURI</td> <td>1</td> <td>PZ</td> </tr> </tbody> </table>	Codice	Descrizione	Qtà	UM	GN1556A0	GUARNIZIONE VENTURI MM	1	PZ	RC1378A0	FASCETTA STRINGI TUBO ZINCATA	3	PZ	TB1520A0	TUBO D.INT=30 SP=4 GOMMA EPDM NERO	0.170	M	VE1135A0	ATTUATORE VENTURI 220V 50/60 HZ SERIE 2	1	PZ	VI1032A0	VITE M4X16 TCB+ INOX	1	PZ	VI1220A1	VITE AUTOFILETTA NTE 4.2X11 TCS+ MARUTE	6	PZ	VM2345A0	CORPO SUPERIORE VENTURI MM	1	PZ	VM2346A0	CORPO INFERIORE VENTURI MM	1	PZ	VM2347A0	COPERCHIETT O VENTURI MIND.MAPS	1	PZ	VM2348A0	DISTANZIALE PIATTELLO VENTURI	1	PZ	VM2349A0	BOCCOLA INFERIORE VENTURI	1	PZ
Codice	Descrizione	Qtà	UM																																																		
GN1556A0	GUARNIZIONE VENTURI MM	1	PZ																																																		
RC1378A0	FASCETTA STRINGI TUBO ZINCATA	3	PZ																																																		
TB1520A0	TUBO D.INT=30 SP=4 GOMMA EPDM NERO	0.170	M																																																		
VE1135A0	ATTUATORE VENTURI 220V 50/60 HZ SERIE 2	1	PZ																																																		
VI1032A0	VITE M4X16 TCB+ INOX	1	PZ																																																		
VI1220A1	VITE AUTOFILETTA NTE 4.2X11 TCS+ MARUTE	6	PZ																																																		
VM2345A0	CORPO SUPERIORE VENTURI MM	1	PZ																																																		
VM2346A0	CORPO INFERIORE VENTURI MM	1	PZ																																																		
VM2347A0	COPERCHIETT O VENTURI MIND.MAPS	1	PZ																																																		
VM2348A0	DISTANZIALE PIATTELLO VENTURI	1	PZ																																																		
VM2349A0	BOCCOLA INFERIORE VENTURI	1	PZ																																																		
GN1584A	RACCORDO ANGOLARE D30-D16		KG1584A	KIT RACCORDO ANGOLARE D30-D16	<table border="1"> <thead> <tr> <th>Codice</th> <th>Descrizione</th> <th>Qtà</th> <th>UM</th> </tr> </thead> <tbody> <tr> <td>GN1584A0</td> <td>RACCORDO ANGOLARE D30-D16</td> <td>1</td> <td>PZ</td> </tr> </tbody> </table>	Codice	Descrizione	Qtà	UM	GN1584A0	RACCORDO ANGOLARE D30-D16	1	PZ																																								
Codice	Descrizione	Qtà	UM																																																		
GN1584A0	RACCORDO ANGOLARE D30-D16	1	PZ																																																		

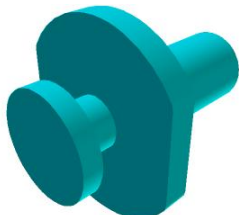

COMPONENTE			RICAMBIO																																																																									
Codice	Descrizione	Immagine	Codice	Descrizione	Lista componenti																																																																							
TB1956A	TB1520A-TUBO GRIGIO SILICONE L=0,04M		KVE1135A	KIT RICAMBIO VENTURI FORNI SERIE 5/E	<table border="1"> <thead> <tr> <th>Codice</th> <th>Descrizione</th> <th>Qtà</th> <th>UM</th> </tr> </thead> <tbody> <tr> <td>GN1310A0</td> <td>GUARNIZIONE PIATTELLO VENTURI SILICONE</td> <td>1</td> <td>PZ</td> </tr> <tr> <td>GN1556A0</td> <td>GUARNIZIONE VENTURI MM</td> <td>1</td> <td>PZ</td> </tr> <tr> <td>RC1378A0</td> <td>FASCETTA STRINGI TUBO ZINCATA</td> <td>2</td> <td>PZ</td> </tr> <tr> <td>TB1520A0</td> <td>TUBO D.INT=30 SP=4 GOMMA EPDM NERO</td> <td>0.050</td> <td>M</td> </tr> <tr> <td>VE1135A0</td> <td>ATTUATORE VENTURI 220V 50/60 HZ SERIE 2</td> <td>1</td> <td>PZ</td> </tr> <tr> <td>VI1032A0</td> <td>VITE M4X16 TCB+ INOX</td> <td>1</td> <td>PZ</td> </tr> <tr> <td>VI1511A0</td> <td>RONDELLA PIANA 4.2X12X1 INOX</td> <td>2</td> <td>PZ</td> </tr> <tr> <td>VI1850A0</td> <td>VITE M4X6 TCB+ NICHELATA</td> <td>2</td> <td>PZ</td> </tr> <tr> <td>VI1865A0</td> <td>VITE AUTOFIL. 5X10 TCB+</td> <td>3</td> <td>PZ</td> </tr> <tr> <td>VM1565B0</td> <td>PORTA BOBINA INFERIORE VENTURI CT B</td> <td>1</td> <td>PZ</td> </tr> <tr> <td>VM1566A0</td> <td>PORTA BOBINA SUPERIORE VENTURI</td> <td>1</td> <td>PZ</td> </tr> <tr> <td>VM1567A0</td> <td>BOCCOLA INFERIORE VENTURI</td> <td>1</td> <td>PZ</td> </tr> <tr> <td>VM1568A0</td> <td>DISTANZIALE PIATTELLO VENTURI</td> <td>1</td> <td>PZ</td> </tr> </tbody> </table>	Codice	Descrizione	Qtà	UM	GN1310A0	GUARNIZIONE PIATTELLO VENTURI SILICONE	1	PZ	GN1556A0	GUARNIZIONE VENTURI MM	1	PZ	RC1378A0	FASCETTA STRINGI TUBO ZINCATA	2	PZ	TB1520A0	TUBO D.INT=30 SP=4 GOMMA EPDM NERO	0.050	M	VE1135A0	ATTUATORE VENTURI 220V 50/60 HZ SERIE 2	1	PZ	VI1032A0	VITE M4X16 TCB+ INOX	1	PZ	VI1511A0	RONDELLA PIANA 4.2X12X1 INOX	2	PZ	VI1850A0	VITE M4X6 TCB+ NICHELATA	2	PZ	VI1865A0	VITE AUTOFIL. 5X10 TCB+	3	PZ	VM1565B0	PORTA BOBINA INFERIORE VENTURI CT B	1	PZ	VM1566A0	PORTA BOBINA SUPERIORE VENTURI	1	PZ	VM1567A0	BOCCOLA INFERIORE VENTURI	1	PZ	VM1568A0	DISTANZIALE PIATTELLO VENTURI	1	PZ	KTB1002A	KIT TUBO EPDM NERO 60MT TB1520	<table border="1"> <thead> <tr> <th>Codice</th> <th>Descrizione</th> <th>Qtà</th> <th>UM</th> </tr> </thead> <tbody> <tr> <td>IL1206C0</td> <td>PALETTA LEGNO 968X1053 H126 XBC</td> <td>1</td> <td>PZ</td> </tr> <tr> <td>TB1520A0</td> <td>TUBO D.INT=30 SP=4 GOMMA EPDM NERO</td> <td>60</td> <td>M</td> </tr> </tbody> </table>	Codice	Descrizione	Qtà	UM	IL1206C0	PALETTA LEGNO 968X1053 H126 XBC	1	PZ	TB1520A0	TUBO D.INT=30 SP=4 GOMMA EPDM NERO	60	M
			Codice	Descrizione	Qtà	UM																																																																						
GN1310A0	GUARNIZIONE PIATTELLO VENTURI SILICONE	1	PZ																																																																									
GN1556A0	GUARNIZIONE VENTURI MM	1	PZ																																																																									
RC1378A0	FASCETTA STRINGI TUBO ZINCATA	2	PZ																																																																									
TB1520A0	TUBO D.INT=30 SP=4 GOMMA EPDM NERO	0.050	M																																																																									
VE1135A0	ATTUATORE VENTURI 220V 50/60 HZ SERIE 2	1	PZ																																																																									
VI1032A0	VITE M4X16 TCB+ INOX	1	PZ																																																																									
VI1511A0	RONDELLA PIANA 4.2X12X1 INOX	2	PZ																																																																									
VI1850A0	VITE M4X6 TCB+ NICHELATA	2	PZ																																																																									
VI1865A0	VITE AUTOFIL. 5X10 TCB+	3	PZ																																																																									
VM1565B0	PORTA BOBINA INFERIORE VENTURI CT B	1	PZ																																																																									
VM1566A0	PORTA BOBINA SUPERIORE VENTURI	1	PZ																																																																									
VM1567A0	BOCCOLA INFERIORE VENTURI	1	PZ																																																																									
VM1568A0	DISTANZIALE PIATTELLO VENTURI	1	PZ																																																																									
Codice	Descrizione	Qtà	UM																																																																									
IL1206C0	PALETTA LEGNO 968X1053 H126 XBC	1	PZ																																																																									
TB1520A0	TUBO D.INT=30 SP=4 GOMMA EPDM NERO	60	M																																																																									

COMPONENTE			RICAMBIO																						
Codice	Descrizione	Immagine	Codice	Descrizione	Lista componenti																				
TB1956A	TB1520A-TUBO GRIGIO SILICONE L=0,04M		KTB1001A	KIT TUBO EPDM NERO 10MT TB1520	<table border="1"> <thead> <tr> <th>Codice</th> <th>Descrizione</th> <th>Qtà</th> <th>UM</th> </tr> </thead> <tbody> <tr> <td>TB1520A0</td> <td>TUBO D.INT=30 SP=4 GOMMA EPDM NERO</td> <td>10</td> <td>M</td> </tr> <tr> <td>VM1794A0</td> <td>FASCETTA 250X4.8 PA66 NERA</td> <td>3</td> <td>PZ</td> </tr> </tbody> </table>	Codice	Descrizione	Qtà	UM	TB1520A0	TUBO D.INT=30 SP=4 GOMMA EPDM NERO	10	M	VM1794A0	FASCETTA 250X4.8 PA66 NERA	3	PZ								
			Codice	Descrizione	Qtà	UM																			
TB1520A0	TUBO D.INT=30 SP=4 GOMMA EPDM NERO	10	M																						
VM1794A0	FASCETTA 250X4.8 PA66 NERA	3	PZ																						
KTB1000A	KIT TUBO EPDM NERO 2MT TB1520A	<table border="1"> <thead> <tr> <th>Codice</th> <th>Descrizione</th> <th>Qtà</th> <th>UM</th> </tr> </thead> <tbody> <tr> <td>RC1055A0</td> <td>FASCETTA STRINGI TUBO Ø25-40 H12 INOX</td> <td>2</td> <td>PZ</td> </tr> <tr> <td>TB1520A0</td> <td>TUBO D.INT=30 SP=4 GOMMA EPDM NERO</td> <td>2</td> <td>M</td> </tr> <tr> <td>VM1059A1</td> <td>FILM TERMORETRA IBILE H800</td> <td>0.500</td> <td>M</td> </tr> </tbody> </table>	Codice	Descrizione	Qtà	UM	RC1055A0	FASCETTA STRINGI TUBO Ø25-40 H12 INOX	2	PZ	TB1520A0	TUBO D.INT=30 SP=4 GOMMA EPDM NERO	2	M	VM1059A1	FILM TERMORETRA IBILE H800	0.500	M							
Codice	Descrizione	Qtà	UM																						
RC1055A0	FASCETTA STRINGI TUBO Ø25-40 H12 INOX	2	PZ																						
TB1520A0	TUBO D.INT=30 SP=4 GOMMA EPDM NERO	2	M																						
VM1059A1	FILM TERMORETRA IBILE H800	0.500	M																						
RC1042A	FASCETTA BIFILARE A MOLLA D21.5-22.6 TUB		RC1042A0	FASCETTA BIFILARE A MOLLA D21.5-22.6 TUB																					
PE1710B	SENSORE GIRI E VERSO ROTAZIONE MOTORE		KPE1710B	KIT SENSORE NUMERO GIRI MOTORE	<table border="1"> <thead> <tr> <th>Codice</th> <th>Descrizione</th> <th>Qtà</th> <th>UM</th> </tr> </thead> <tbody> <tr> <td>PE1710B0</td> <td>SENSORE GIRI E VERSO ROTAZIONE MOTORE</td> <td>1</td> <td>PZ</td> </tr> <tr> <td>VE1550A0</td> <td>MAGNETE NEODIMIO 5X3 MM</td> <td>1</td> <td>PZ</td> </tr> <tr> <td>VI1966A0</td> <td>VITE M4X14 TSP+ZN</td> <td>1</td> <td>PZ</td> </tr> <tr> <td>VM1635A0</td> <td>DISCO SUPPORTO MAGNETE</td> <td>1</td> <td>PZ</td> </tr> </tbody> </table>	Codice	Descrizione	Qtà	UM	PE1710B0	SENSORE GIRI E VERSO ROTAZIONE MOTORE	1	PZ	VE1550A0	MAGNETE NEODIMIO 5X3 MM	1	PZ	VI1966A0	VITE M4X14 TSP+ZN	1	PZ	VM1635A0	DISCO SUPPORTO MAGNETE	1	PZ
			Codice	Descrizione	Qtà	UM																			
			PE1710B0	SENSORE GIRI E VERSO ROTAZIONE MOTORE	1	PZ																			
			VE1550A0	MAGNETE NEODIMIO 5X3 MM	1	PZ																			
VI1966A0	VITE M4X14 TSP+ZN	1	PZ																						
VM1635A0	DISCO SUPPORTO MAGNETE	1	PZ																						

COMPONENTE			RICAMBIO																														
Codice	Descrizione	Immagine	Codice	Descrizione	Lista componenti																												
VE1550A	MAGNETE NEODIMIO 5X3 MM		VE1550A0	MAGNETE NEODIMIO 5X3 MM																													
GN1588A	GUARNIZIONE RESISTENZA 78X28 G6.25		GN1588A0	GUARNIZIONE RESISTENZA 78X28 G6.25																													
VM2416A	PERNO GUIDA BLOCCA SMOKER		VM2416A0	PERNO GUIDA BLOCCA SMOKER																													
0H6739A	STAFFA SOSTEGNO MUFFOLA CT BT		0H6739A0	STAFFA SOSTEGNO MUFFOLA CT BT																													
MT1012A	MOTORE SIMMETRICO 330W 230V ALBERO D12		KMT1012A	KIT MOTORE 330W 230V ALBERO D12	<table border="1"> <thead> <tr> <th>Codice</th> <th>Descrizione</th> <th>Qtà</th> <th>UM</th> </tr> </thead> <tbody> <tr> <td>GN1140A2</td> <td>GUARNIZIONE PORTAMOTO RE STAMPAT</td> <td>1</td> <td>PZ</td> </tr> <tr> <td>MT1012A0</td> <td>MOTORE SIMMETRICO 330W 230V ALBERO D12</td> <td>1</td> <td>PZ</td> </tr> <tr> <td>VI1077A1</td> <td>VITE M6X12 TE INOX</td> <td>1</td> <td>PZ</td> </tr> <tr> <td>VI1521A0</td> <td>RONDELLA PIANA 6X12X1 INOX</td> <td>1</td> <td>PZ</td> </tr> <tr> <td>VM1794A0</td> <td>FASCETTA 250X4.8 PA66 NERA</td> <td>4</td> <td>PZ</td> </tr> <tr> <td>VM2103A0</td> <td>PIASTRINA FERMAFASCE TTA</td> <td>4</td> <td>PZ</td> </tr> </tbody> </table>	Codice	Descrizione	Qtà	UM	GN1140A2	GUARNIZIONE PORTAMOTO RE STAMPAT	1	PZ	MT1012A0	MOTORE SIMMETRICO 330W 230V ALBERO D12	1	PZ	VI1077A1	VITE M6X12 TE INOX	1	PZ	VI1521A0	RONDELLA PIANA 6X12X1 INOX	1	PZ	VM1794A0	FASCETTA 250X4.8 PA66 NERA	4	PZ	VM2103A0	PIASTRINA FERMAFASCE TTA	4	PZ
Codice	Descrizione	Qtà	UM																														
GN1140A2	GUARNIZIONE PORTAMOTO RE STAMPAT	1	PZ																														
MT1012A0	MOTORE SIMMETRICO 330W 230V ALBERO D12	1	PZ																														
VI1077A1	VITE M6X12 TE INOX	1	PZ																														
VI1521A0	RONDELLA PIANA 6X12X1 INOX	1	PZ																														
VM1794A0	FASCETTA 250X4.8 PA66 NERA	4	PZ																														
VM2103A0	PIASTRINA FERMAFASCE TTA	4	PZ																														

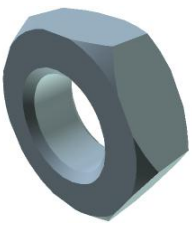
COMPONENTE			RICAMBIO																						
Codice	Descrizione	Immagine	Codice	Descrizione	Lista componenti																				
0H7170A	PREMI LANA DI VETRO MOTORE M		0H7170A0	PREMI LANA DI VETRO MOTORE M																					
GN1140A	GUARNIZIONE PORTAMOTORE STAMPATO		KGN1140A	KIT 5 PZ.GUARNIZIONE PORTAMOTORE	<table border="1"> <thead> <tr> <th>Codice</th> <th>Descrizione</th> <th>Qtà</th> <th>UM</th> </tr> </thead> <tbody> <tr> <td>GN1140A2</td> <td>GUARNIZIONE PORTAMOTO RE STAMPAT</td> <td>5</td> <td>PZ</td> </tr> </tbody> </table>	Codice	Descrizione	Qtà	UM	GN1140A2	GUARNIZIONE PORTAMOTO RE STAMPAT	5	PZ												
Codice	Descrizione	Qtà	UM																						
GN1140A2	GUARNIZIONE PORTAMOTO RE STAMPAT	5	PZ																						
0H4305A	DISCO TENUTA ALBERO MOTORE INOX STP		K0H4305A	KIT DISCO TENUTA 0H4305A	<table border="1"> <thead> <tr> <th>Codice</th> <th>Descrizione</th> <th>Qtà</th> <th>UM</th> </tr> </thead> <tbody> <tr> <td>0H4305A1</td> <td>DISCO TENUTA ALBERO MOTORE INOX STP</td> <td>1</td> <td>PZ</td> </tr> <tr> <td>GN1140A2</td> <td>GUARNIZIONE PORTAMOTO RE STAMPAT</td> <td>1</td> <td>PZ</td> </tr> <tr> <td>SL1045A0</td> <td>SILICONE ANTRACITE S53 80 ML</td> <td>1</td> <td>PZ</td> </tr> <tr> <td>VI1220A1</td> <td>VITE AUTOFILETTA NTE 4.2X11 TCS+ MARUTE</td> <td>3</td> <td>PZ</td> </tr> </tbody> </table>	Codice	Descrizione	Qtà	UM	0H4305A1	DISCO TENUTA ALBERO MOTORE INOX STP	1	PZ	GN1140A2	GUARNIZIONE PORTAMOTO RE STAMPAT	1	PZ	SL1045A0	SILICONE ANTRACITE S53 80 ML	1	PZ	VI1220A1	VITE AUTOFILETTA NTE 4.2X11 TCS+ MARUTE	3	PZ
Codice	Descrizione	Qtà	UM																						
0H4305A1	DISCO TENUTA ALBERO MOTORE INOX STP	1	PZ																						
GN1140A2	GUARNIZIONE PORTAMOTO RE STAMPAT	1	PZ																						
SL1045A0	SILICONE ANTRACITE S53 80 ML	1	PZ																						
VI1220A1	VITE AUTOFILETTA NTE 4.2X11 TCS+ MARUTE	3	PZ																						
VN1170B	VENTOLA D195 H80 8 PALE DADO M8 + ANELLO		KVN1170B	KIT VENTOLA D195 H80 8 PALE DADO M8+ANEL	<table border="1"> <thead> <tr> <th>Codice</th> <th>Descrizione</th> <th>Qtà</th> <th>UM</th> </tr> </thead> <tbody> <tr> <td>VI1077A1</td> <td>VITE M6X12 TE INOX</td> <td>1</td> <td>PZ</td> </tr> <tr> <td>VI1521A0</td> <td>RONDELLA PIANA 6X12X1 INOX</td> <td>1</td> <td>PZ</td> </tr> <tr> <td>VN1170B0</td> <td>VENTOLA D195 H80 8 PALE DADO M8 + ANELLO</td> <td>1</td> <td>PZ</td> </tr> </tbody> </table>	Codice	Descrizione	Qtà	UM	VI1077A1	VITE M6X12 TE INOX	1	PZ	VI1521A0	RONDELLA PIANA 6X12X1 INOX	1	PZ	VN1170B0	VENTOLA D195 H80 8 PALE DADO M8 + ANELLO	1	PZ				
Codice	Descrizione	Qtà	UM																						
VI1077A1	VITE M6X12 TE INOX	1	PZ																						
VI1521A0	RONDELLA PIANA 6X12X1 INOX	1	PZ																						
VN1170B0	VENTOLA D195 H80 8 PALE DADO M8 + ANELLO	1	PZ																						

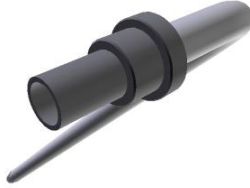
COMPONENTE			RICAMBIO																																														
Codice	Descrizione	Immagine	Codice	Descrizione	Lista componenti																																												
GN1555A	GUARNIZIONE PORTA XEVC-2011		KGN1555B KGN1555A	KIT GUARNIZIONE PORTA 16EU/2011/2021 KIT GUARNIZIONE PORTA 16EU/2011/2021	<table border="1"> <thead> <tr> <th>Codice</th> <th>Descrizione</th> <th>Qtà</th> <th>UM</th> </tr> </thead> <tbody> <tr> <td>0H1604A0</td> <td>PIASTRINA COPRIFORI FERMAVETRO BIG</td> <td>2</td> <td>PZ</td> </tr> <tr> <td>GN1006A1</td> <td>GUARNIZIONE FACCIATA PORTA BANDIERA</td> <td>4.190</td> <td>M</td> </tr> <tr> <td>GN1008A0</td> <td>GUARNIZIONE INTERNA PER GIUNZIONE GN1006</td> <td>0.030</td> <td>M</td> </tr> <tr> <td>SL1025A0</td> <td>TUBETTO SIL.90ML DOW CORNING 734 CLEAR</td> <td>0.010</td> <td>PZ</td> </tr> <tr> <td>VM2277A0</td> <td>SPINA KIT GUARNIZIONE PORTA</td> <td>1</td> <td>PZ</td> </tr> </tbody> </table> <table border="1"> <thead> <tr> <th>Codice</th> <th>Descrizione</th> <th>Qtà</th> <th>UM</th> </tr> </thead> <tbody> <tr> <td>GN1006A1</td> <td>GUARNIZIONE FACCIATA PORTA BANDIERA</td> <td>4.090</td> <td>M</td> </tr> <tr> <td>GN1008A0</td> <td>GUARNIZIONE INTERNA PER GIUNZIONE GN1006</td> <td>0.030</td> <td>M</td> </tr> <tr> <td>SL1025A0</td> <td>TUBETTO SIL.90ML DOW CORNING 734 CLEAR</td> <td>0.012</td> <td>PZ</td> </tr> <tr> <td>VM2277A0</td> <td>SPINA KIT GUARNIZIONE PORTA</td> <td>1</td> <td>PZ</td> </tr> </tbody> </table>	Codice	Descrizione	Qtà	UM	0H1604A0	PIASTRINA COPRIFORI FERMAVETRO BIG	2	PZ	GN1006A1	GUARNIZIONE FACCIATA PORTA BANDIERA	4.190	M	GN1008A0	GUARNIZIONE INTERNA PER GIUNZIONE GN1006	0.030	M	SL1025A0	TUBETTO SIL.90ML DOW CORNING 734 CLEAR	0.010	PZ	VM2277A0	SPINA KIT GUARNIZIONE PORTA	1	PZ	Codice	Descrizione	Qtà	UM	GN1006A1	GUARNIZIONE FACCIATA PORTA BANDIERA	4.090	M	GN1008A0	GUARNIZIONE INTERNA PER GIUNZIONE GN1006	0.030	M	SL1025A0	TUBETTO SIL.90ML DOW CORNING 734 CLEAR	0.012	PZ	VM2277A0	SPINA KIT GUARNIZIONE PORTA	1	PZ
			Codice	Descrizione	Qtà	UM																																											
0H1604A0	PIASTRINA COPRIFORI FERMAVETRO BIG	2	PZ																																														
GN1006A1	GUARNIZIONE FACCIATA PORTA BANDIERA	4.190	M																																														
GN1008A0	GUARNIZIONE INTERNA PER GIUNZIONE GN1006	0.030	M																																														
SL1025A0	TUBETTO SIL.90ML DOW CORNING 734 CLEAR	0.010	PZ																																														
VM2277A0	SPINA KIT GUARNIZIONE PORTA	1	PZ																																														
Codice	Descrizione	Qtà	UM																																														
GN1006A1	GUARNIZIONE FACCIATA PORTA BANDIERA	4.090	M																																														
GN1008A0	GUARNIZIONE INTERNA PER GIUNZIONE GN1006	0.030	M																																														
SL1025A0	TUBETTO SIL.90ML DOW CORNING 734 CLEAR	0.012	PZ																																														
VM2277A0	SPINA KIT GUARNIZIONE PORTA	1	PZ																																														
RC1170A	DADO M14 H=8 CH=22 INOX		KRC1170A	KIT 10 DADI M14 H8 CH22 INOX	<table border="1"> <thead> <tr> <th>Codice</th> <th>Descrizione</th> <th>Qtà</th> <th>UM</th> </tr> </thead> <tbody> <tr> <td>RC1170A1</td> <td>DADO M14 H=8 CH=22 INOX</td> <td>10</td> <td>PZ</td> </tr> </tbody> </table>	Codice	Descrizione	Qtà	UM	RC1170A1	DADO M14 H=8 CH=22 INOX	10	PZ																																				
Codice	Descrizione	Qtà	UM																																														
RC1170A1	DADO M14 H=8 CH=22 INOX	10	PZ																																														

COMPONENTE			RICAMBIO																																										
Codice	Descrizione	Immagine	Codice	Descrizione	Lista componenti																																								
TB2937B	TUBO EST UMIDITA' D10 CON RACCORDO XEBC		TB2937B0	TUBO EST UMIDITA' D10 CON RACCORDO XEBC																																									
VL1037A	GIRANTE LAVAGGIO		KVL1037A	KIT RICAMBIO GIRANTE LAVAGGIO	<table border="1"> <thead> <tr> <th>Codice</th> <th>Descrizione</th> <th>Qtà</th> <th>UM</th> </tr> </thead> <tbody> <tr> <td>GN1416B0</td> <td>BRONZINA GIRANTE LAVAGGIO</td> <td>1</td> <td>PZ</td> </tr> <tr> <td>TF1065B0</td> <td>PERNO ROTAZIONE GIRANTE LAVAGGIO</td> <td>1</td> <td>PZ</td> </tr> <tr> <td>TF1066A1</td> <td>BOCCOLA GIRANTE LAVAGGIO</td> <td>1</td> <td>PZ</td> </tr> <tr> <td>UG1005B1</td> <td>UGELLO ACQUA GETTO LARGO GIRANTE</td> <td>1</td> <td>PZ</td> </tr> <tr> <td>UG1006B3</td> <td>UGELLO ACQUA GETTO LUNGO GIRANTE</td> <td>1</td> <td>PZ</td> </tr> <tr> <td>VI1220A1</td> <td>VITE AUTOFILETTA NTE 4.2X11 TCS+ MARUTE</td> <td>6</td> <td>PZ</td> </tr> <tr> <td>VM1955C0</td> <td>CORPO GIRANTE LAVAGGIO</td> <td>1</td> <td>PZ</td> </tr> <tr> <td>VM1985C1</td> <td>COPERCHIO GIRANTE LAVAGGIO</td> <td>1</td> <td>PZ</td> </tr> <tr> <td>VM1986A0</td> <td>TAPPO UGELL</td> <td>1</td> <td>PZ</td> </tr> </tbody> </table>	Codice	Descrizione	Qtà	UM	GN1416B0	BRONZINA GIRANTE LAVAGGIO	1	PZ	TF1065B0	PERNO ROTAZIONE GIRANTE LAVAGGIO	1	PZ	TF1066A1	BOCCOLA GIRANTE LAVAGGIO	1	PZ	UG1005B1	UGELLO ACQUA GETTO LARGO GIRANTE	1	PZ	UG1006B3	UGELLO ACQUA GETTO LUNGO GIRANTE	1	PZ	VI1220A1	VITE AUTOFILETTA NTE 4.2X11 TCS+ MARUTE	6	PZ	VM1955C0	CORPO GIRANTE LAVAGGIO	1	PZ	VM1985C1	COPERCHIO GIRANTE LAVAGGIO	1	PZ	VM1986A0	TAPPO UGELL	1	PZ
Codice	Descrizione	Qtà	UM																																										
GN1416B0	BRONZINA GIRANTE LAVAGGIO	1	PZ																																										
TF1065B0	PERNO ROTAZIONE GIRANTE LAVAGGIO	1	PZ																																										
TF1066A1	BOCCOLA GIRANTE LAVAGGIO	1	PZ																																										
UG1005B1	UGELLO ACQUA GETTO LARGO GIRANTE	1	PZ																																										
UG1006B3	UGELLO ACQUA GETTO LUNGO GIRANTE	1	PZ																																										
VI1220A1	VITE AUTOFILETTA NTE 4.2X11 TCS+ MARUTE	6	PZ																																										
VM1955C0	CORPO GIRANTE LAVAGGIO	1	PZ																																										
VM1985C1	COPERCHIO GIRANTE LAVAGGIO	1	PZ																																										
VM1986A0	TAPPO UGELL	1	PZ																																										
VL1037A	GIRANTE LAVAGGIO		KVL1037A	KIT RICAMBIO GIRANTE LAVAGGIO	<table border="1"> <thead> <tr> <th>Codice</th> <th>Descrizione</th> <th>Qtà</th> <th>UM</th> </tr> </thead> <tbody> <tr> <td>GN1416B0</td> <td>BRONZINA GIRANTE LAVAGGIO</td> <td>1</td> <td>PZ</td> </tr> <tr> <td>TF1065B0</td> <td>PERNO ROTAZIONE GIRANTE LAVAGGIO</td> <td>1</td> <td>PZ</td> </tr> <tr> <td>TF1066A1</td> <td>BOCCOLA GIRANTE LAVAGGIO</td> <td>1</td> <td>PZ</td> </tr> </tbody> </table>	Codice	Descrizione	Qtà	UM	GN1416B0	BRONZINA GIRANTE LAVAGGIO	1	PZ	TF1065B0	PERNO ROTAZIONE GIRANTE LAVAGGIO	1	PZ	TF1066A1	BOCCOLA GIRANTE LAVAGGIO	1	PZ																								
Codice	Descrizione	Qtà	UM																																										
GN1416B0	BRONZINA GIRANTE LAVAGGIO	1	PZ																																										
TF1065B0	PERNO ROTAZIONE GIRANTE LAVAGGIO	1	PZ																																										
TF1066A1	BOCCOLA GIRANTE LAVAGGIO	1	PZ																																										

COMPONENTE			RICAMBIO																														
Codice	Descrizione	Immagine	Codice	Descrizione	Lista componenti																												
VL1037A	GIRANTE LAVAGGIO		KVL1037A	KIT RICAMBIO GIRANTE LAVAGGIO	<table border="1"> <thead> <tr> <th>Codice</th> <th>Descrizione</th> <th>Qtà</th> <th>UM</th> </tr> </thead> <tbody> <tr> <td>UG1005B1</td> <td>UGELLO ACQUA GETTO LARGO GIRANTE</td> <td>1</td> <td>PZ</td> </tr> <tr> <td>UG1006B3</td> <td>UGELLO ACQUA GETTO LUNGO GIRANTE</td> <td>1</td> <td>PZ</td> </tr> <tr> <td>VI1220A1</td> <td>VITE AUTOFILETTA NTE 4.2X11 TCS+ MARUTE</td> <td>6</td> <td>PZ</td> </tr> <tr> <td>VM1955C0</td> <td>CORPO GIRANTE LAVAGGIO</td> <td>1</td> <td>PZ</td> </tr> <tr> <td>VM1985C1</td> <td>COPERCHIO GIRANTE LAVAGGIO</td> <td>1</td> <td>PZ</td> </tr> <tr> <td>VM1986A0</td> <td>TAPPO UGELL</td> <td>1</td> <td>PZ</td> </tr> </tbody> </table>	Codice	Descrizione	Qtà	UM	UG1005B1	UGELLO ACQUA GETTO LARGO GIRANTE	1	PZ	UG1006B3	UGELLO ACQUA GETTO LUNGO GIRANTE	1	PZ	VI1220A1	VITE AUTOFILETTA NTE 4.2X11 TCS+ MARUTE	6	PZ	VM1955C0	CORPO GIRANTE LAVAGGIO	1	PZ	VM1985C1	COPERCHIO GIRANTE LAVAGGIO	1	PZ	VM1986A0	TAPPO UGELL	1	PZ
Codice	Descrizione	Qtà	UM																														
UG1005B1	UGELLO ACQUA GETTO LARGO GIRANTE	1	PZ																														
UG1006B3	UGELLO ACQUA GETTO LUNGO GIRANTE	1	PZ																														
VI1220A1	VITE AUTOFILETTA NTE 4.2X11 TCS+ MARUTE	6	PZ																														
VM1955C0	CORPO GIRANTE LAVAGGIO	1	PZ																														
VM1985C1	COPERCHIO GIRANTE LAVAGGIO	1	PZ																														
VM1986A0	TAPPO UGELL	1	PZ																														