



# Spare Parts for Ovens & Combi Ovens



Spare parts suitable for

# UNOX

# 2018

Find the complete and up-to-date range of products in our GEV Webshop



## heating elements

## heating elements for ovens



<b>GEV No.</b>	417566	<b>Ref. No.</b>	RS1261A0
<b>description</b>	heating element 122W 105V heating circuits 1 L 85mm W 31mm flange length 70mm flange width 22mm hole distance 56mm hole $\varnothing$ 5mm tube $\varnothing$ 6.25mm connection male faston 6.3mm connection length 87mm rectangular flange dry heating element		
<b>For models:</b>	XB693, XB695, XB893, XB895, XV593		



<b>GEV No.</b>	417565	<b>Ref. No.</b>	KRS1261A
<b>description</b>	heating element 122W 105V heating circuits 1 L 85mm W 31mm flange length 70mm flange width 22mm hole distance 56mm hole $\varnothing$ 5mm tube $\varnothing$ 6.25mm connection male faston 6.3mm connection length 87mm rectangular flange dry heating element with gasket and silicone		



<b>GEV No.</b>	417549	<b>Ref. No.</b>	RS1215A0
<b>description</b>	heating element 147W 105V heating circuits 1 L 88mm W 30.5mm flange length 78mm flange width 28mm hole distance 55mm tube $\varnothing$ 6.3mm connection male faston 6.3mm connection length 85mm		
<b>For models:</b>	XBC1005, XBC605, XBC805, XBC815G, XVC1005P, XVC1015G, XVC105, XVC205, XVC305, XVC315G, XVC505, XVC515G, XVC705, XVC715G, XVC905P		



<b>GEV No.</b>	417548	<b>Ref. No.</b>	KRS1215A
<b>description</b>	heating element 147W 105V heating circuits 1 L 88mm W 30.5mm flange length 78mm flange width 28mm hole distance 55mm tube $\varnothing$ 6.3mm connection male faston 6.3mm connection length 85mm with gasket and silicone		

## heating elements for convection



<b>GEV No.</b>	420192	<b>Ref. No.</b>	RS090
<b>description</b>	heating element 1260W 230V heating circuits 1 ID $\varnothing$ 178mm ED $\varnothing$ 190mm L 244mm H 31mm L1 47mm W1 31mm H1 6mm H2 25mm flange length 70mm flange width 22mm hole distance 56mm connection male faston 6.3mm tube $\varnothing$ 6.3mm convection heating element hole $\varnothing$ 5mm flange connection		
<b>For models:</b>	XF030, XF030-TG, XF040, XF050, XF065		



<b>GEV No.</b>	417608	<b>Ref. No.</b>	KRS0090A KRS011
<b>description</b>	heating element 1260W 230V heating circuits 1 ID $\varnothing$ 178mm ED $\varnothing$ 190mm L 244mm H 31mm L1 47mm W1 31mm H1 6mm H2 25mm flange length 70mm flange width 22mm hole distance 56mm connection male faston 6.3mm tube $\varnothing$ 6.3mm convection heating element hole $\varnothing$ 5mm flange connection with gasket and silicone		

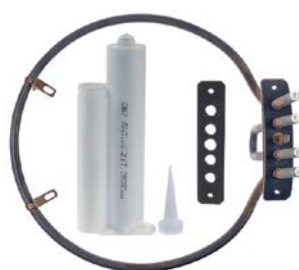



<b>GEV No.</b>	417558	<b>Ref. No.</b>	KRS1240A
<b>description</b>	heating element 147/1300W 105/230V heating circuits 2 ID $\varnothing$ 218mm ED $\varnothing$ 236mm L 240mm H 15mm W1 70mm H1 5mm flange length 110mm flange width 22mm hole distance 18mm connection male faston 6.3mm with gasket and silicone		





<b>GEV No.</b>	417563	<b>Ref. No.</b>	RS1240A0
<b>description</b>	heating element 147/1300W 105/230V heating circuits 2 ID $\varnothing$ 220mm ED $\varnothing$ 236mm L 242mm H 96mm W1 74mm H1 5mm H2 26mm flange length 110mm flange width 22mm hole distance 94mm connection male faston 6.3mm		
<b>For models:</b>	XVC2015G		





			
1			
<b>GEV No.</b>	417561	<b>Ref. No.</b>	KRS002 KRS0023A RS023A
<b>description</b>	heating element 2560W 230V heating circuits 1 ID ø 220mm ED ø 235mm L 255mm H 45mm L1 20mm W1 30mm H1 8mm H2 30mm flange length 99mm flange width 21mm hole distance 86mm connection male faston 6.3mm connection length 60mm tube ø 6.3mm convection heating element hole ø 5mm rectangular flange with gasket and silicone		

			
1			
<b>GEV No.</b>	417562	<b>Ref. No.</b>	RS0023A0
<b>description</b>	heating element 2560W 230V heating circuits 1 ID ø 220mm ED ø 235mm L 265mm H 45mm L1 30mm W1 30mm H1 8mm H2 32mm flange length 100mm flange width 22mm hole distance 86mm connection male faston 6.3mm connection length 60mm tube ø 6.3mm convection heating element hole ø 5mm rectangular flange		

			
1			
<b>GEV No.</b>	418746	<b>Ref. No.</b>	KRS020 KRS1130A RS1130A0
<b>description</b>	heating element 2900W 230V heating circuits 1 ID ø 220mm ED ø 235mm L 268mm H 40mm L1 35mm W1 30mm H1 11mm H2 32mm flange length 99mm flange width 21mm hole distance 86mm connection male faston 6.3mm connection length 60mm tube ø 6.3mm convection heating element hole ø 5mm rectangular flange		
<b>For models:</b>	XF023, XF100, XF103, XF110, XF113, XF115, XF119, XF130, XF133, XF135		

			
1			
<b>GEV No.</b>	418745	<b>Ref. No.</b>	KRS016 KRS1090A RS1090A0 RS1090A1
<b>description</b>	heating element 2900W 230V heating circuits 1 ID ø 220mm ED ø 235mm L 268mm H 75mm L1 35mm W1 30mm H1 11mm H2 32mm flange length 99mm flange width 21mm hole distance 86mm connection male faston 6.3mm connection length 60mm tube ø 6.3mm convection heating element hole ø 5mm rectangular flange		
<b>For models:</b>	XF183, XF185, XF190, XF193, XF195, XVC054, XVC104		
<b>accessories for</b>	418745		
		<b>GEV No.</b>	550986
		<b>Ref. No.</b>	GN1280 GN1327A0 GN224
	gasket L 100mm W 22mm 7 holes graphite thickness 1mm for heating element		

			
1			
<b>GEV No.</b>	419142	<b>Ref. No.</b>	KRS003 KRS1026 KRS1026 + GN 1280 KRS1026A RS026 RS026A RS026B
<b>description</b>	heating element 3100W 230V heating circuits 1 ID ø 220mm ED ø 235mm H 45mm L1 25mm W1 25mm H1 8mm H2 30mm flange length 99mm flange width 21mm hole distance 86mm connection male faston 6.3mm connection length 60mm tube ø 6.3mm convection heating element hole ø 5mm rectangular flange		
<b>For models:</b>	XF090P		
<b>accessories for</b>	419142		
		<b>GEV No.</b>	550986
		<b>Ref. No.</b>	GN1280 GN1327A0 GN224
	gasket L 100mm W 22mm 7 holes graphite thickness 1mm for heating element		

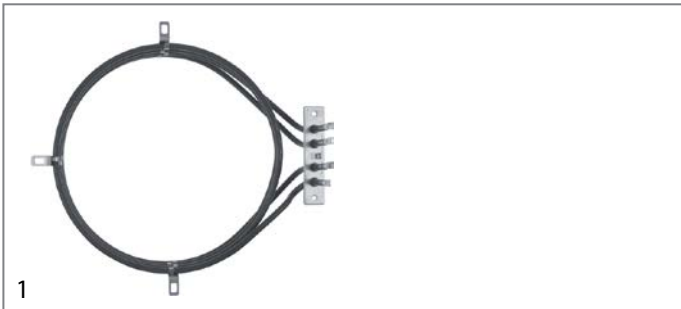

<b>GEV No.</b>	419111	<b>Ref. No.</b>	RS076 RS076A RS076B RS1040A0
<b>description</b>	heating element 4250W 230V heating circuits 2 ID ø 220mm ED ø 235mm L 265mm H 50mm L1 25mm W1 53mm H1 5mm H2 45mm flange length 100mm flange width 22mm hole distance 87mm connection male faston 6.3mm tube ø 6.3mm		
<b>For models:</b>	XB403, XB403G, XB603, XB603G, XBT160, XF188, XV301, XV301E, XV401E		
<b>accessories for</b>	419111		
	<b>GEV No.</b>	550986	<b>Ref. No.</b> GN1280 GN1327A0 GN224
gasket L 100mm W 22mm 7 holes graphite thickness 1mm for heating element			

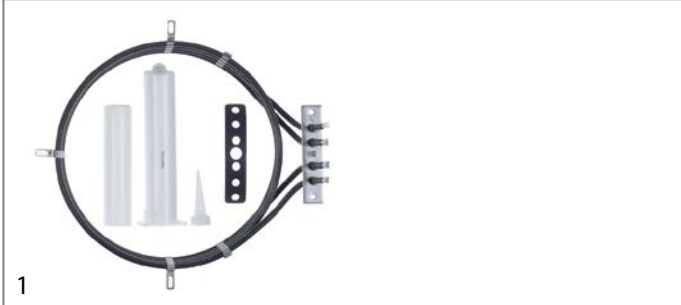

<b>GEV No.</b>	418906	<b>Ref. No.</b>	KRS012 KRS1040A
<b>description</b>	heating element 4250W 230V heating circuits 2 ID ø 220mm ED ø 235mm L 265mm H 50mm L1 25mm W1 53mm H1 5mm H2 45mm flange length 100mm flange width 22mm hole distance 87mm connection male faston 6.3mm tube ø 6.3mm with gasket and silicone		



<b>GEV No.</b>	420417	<b>Ref. No.</b>	RS1115A0
<b>description</b>	heating element 4350W 230V heating circuits 2 ID ø 224mm ED ø 235mm L 270mm H 65mm L1 25mm W1 60mm H1 12mm H2 55mm flange length 100mm flange width 22mm hole distance 86mm connection male faston 6.3mm connection length 60mm tube ø 6.3mm convection heating element hole ø 5mm rectangular flange		

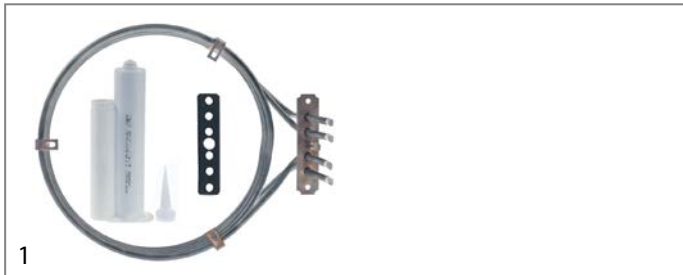

<b>GEV No.</b>	420416	<b>Ref. No.</b>	KRS1115A
<b>description</b>	heating element 4350W 230V heating circuits 2 ID ø 224mm ED ø 235mm L 270mm H 65mm L1 25mm W1 60mm H1 12mm H2 55mm flange length 100mm flange width 22mm hole distance 86mm connection male faston 6.3mm connection length 60mm tube ø 6.3mm convection heating element hole ø 5mm rectangular flange with gasket and silicone		

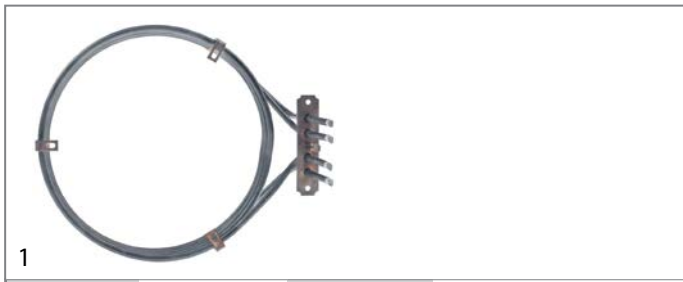

<b>GEV No.</b>	420414	<b>Ref. No.</b>	RS085A
<b>description</b>	heating element 4400W 225V heating circuits 2 ID ø 224mm ED ø 235mm L 270mm H 55mm L1 25mm W1 60mm H1 12mm H2 45mm flange length 100mm flange width 22mm hole distance 86mm connection male faston 6.3mm connection length 60mm tube ø 6.3mm convection heating element hole ø 5mm rectangular flange		

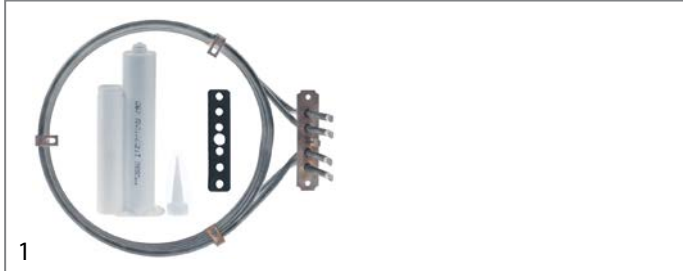

<b>GEV No.</b>	420399	<b>Ref. No.</b>	KRS0085A KRS010
<b>description</b>	heating element 4400W 225V heating circuits 2 ID ø 224mm ED ø 235mm L 270mm H 65mm L1 25mm W1 60mm H1 12mm H2 55mm flange length 100mm flange width 22mm hole distance 86mm connection male faston 6.3mm connection length 60mm tube ø 6.3mm convection heating element hole ø 5mm rectangular flange with gasket and silicone		

1

<b>GEV No.</b>	417551	<b>Ref. No.</b>	RS1225A
<b>description</b>	heating element 4700W 230V heating circuits 3 ID ø 224mm ED ø 235mm L 270mm H 97mm L1 15mm W1 103mm H1 15mm H2 85mm flange length 148mm flange width 31mm hole distance 17mm connection male faston 6.3mm connection length 85mm tube ø 6.3mm convection heating element hole ø 4.5mm rectangular flange		
<b>For models:</b>	XBC405E, XBC605E, XBC805E, XVC055E, XVC105E, XVC105EP, XVC205E, XVC505E, XVC505EP		
<b>accessories for</b>	417551		
	<b>GEV No.</b>	531259	<b>Ref. No.</b> GN1085A0 KGN1085A
	gasket L 141mm W 22mm D1 ø 8mm D2 ø 9mm 9 holes graphite thickness 1mm suitable for UNOX		



1

<b>GEV No.</b>	417557	<b>Ref. No.</b>	RS1150A0
<b>description</b>	heating element 4900W 230V heating circuits 2 ID ø 224mm ED ø 235mm L 270mm H 75mm L1 30mm W1 60mm H1 12mm H2 60mm flange length 100mm flange width 22mm hole distance 86mm connection male faston 6.3mm connection length 65mm tube ø 6.3mm convection heating element hole ø 5mm rectangular flange		
<b>For models:</b>	XB693, XB695, XB893, XB895, XBC404, XBC604, XBC804, XF043, XV593, XVC204, XVC304, XVC504, XVC704		





1

<b>GEV No.</b>	417550	<b>Ref. No.</b>	KRS1225A
<b>description</b>	heating element 4700W 230V heating circuits 3 ID ø 224mm ED ø 235mm L 270mm H 97mm L1 15mm W1 103mm H1 15mm H2 85mm flange length 148mm flange width 31mm hole distance 17mm connection male faston 6.3mm connection length 85mm tube ø 6.3mm convection heating element hole ø 4.5mm rectangular flange with gasket and silicone		



1

<b>GEV No.</b>	419144	<b>Ref. No.</b>	RS1000A0 RS1050A0
<b>description</b>	heating element 5000W 230V heating circuits 2 ID ø 223mm ED ø 236mm L 265mm H 65mm L1 25mm W1 55/25mm H1 6mm H2 59mm flange length 100mm flange width 22mm hole distance 86mm connection male faston 6.3mm tube ø 6.5mm hole ø 5mm		
<b>For models:</b>	XB803, XB803G, XBT146, XV203G, XV303G, XV703G, XVT203G		
<b>accessories for</b>	419144		
	<b>GEV No.</b>	550986	<b>Ref. No.</b> GN1280 GN1327A0 GN224
	gasket L 100mm W 22mm 7 holes graphite thickness 1mm for heating element		





1

<b>GEV No.</b>	417556	<b>Ref. No.</b>	KRS032 KRS1150A
<b>description</b>	heating element 4900W 230V heating circuits 2 ID ø 224mm ED ø 235mm L 270mm H 70mm L1 30mm W1 60mm H1 12mm H2 60mm flange length 100mm flange width 22mm hole distance 86mm connection male faston 6.3mm connection length 85mm tube ø 6.3mm convection heating element hole ø 5mm rectangular flange with gasket and silicone		



1

<b>GEV No.</b>	419017	<b>Ref. No.</b>	KRS013 KRS1050A
<b>description</b>	heating element 5000W 230V heating circuits 2 ID ø 223mm ED ø 236mm L 265mm H 65mm L1 25mm W1 55/25mm H1 6mm H2 59mm flange length 100mm flange width 22mm hole distance 86mm connection male faston 6.3mm tube ø 6.5mm hole ø 5mm with gasket and silicone		
<b>spare parts for</b>	419017		
	<b>GEV No.</b>	550986	<b>Ref. No.</b> GN1280 GN1327A0 GN224
	gasket L 100mm W 22mm 7 holes graphite thickness 1mm for heating element		



1

<b>GEV No.</b>	417553	<b>Ref. No.</b>	RS1205A0
<b>description</b>	heating element 5600W 230V heating circuits 3 ID $\varnothing$ 224mm ED $\varnothing$ 235mm L 270mm H 97mm L1 15mm W1 103mm H1 15mm H2 85mm flange length 148mm flange width 31mm hole distance 17mm connection male faston 6.3mm connection length 85mm tube $\varnothing$ 6.3mm convection heating element hole $\varnothing$ 4.5mm rectangular flange		
<b>For models:</b>	XBC1005, XVC1005P, XVC305, XVC705, XVC905P		



1

<b>GEV No.</b>	417552	<b>Ref. No.</b>	KRS1205A
<b>description</b>	heating element 5600W 230V heating circuits 3 ID $\varnothing$ 224mm ED $\varnothing$ 235mm L 270mm H 97mm L1 15mm W1 103mm H1 15mm H2 85mm flange length 148mm flange width 31mm hole distance 17mm connection male faston 6.3mm connection length 85mm tube $\varnothing$ 6.3mm convection heating element hole $\varnothing$ 4.5mm rectangular flange with gasket and silicone		



1

<b>GEV No.</b>	417560	<b>Ref. No.</b>	KRS1180A
<b>description</b>	heating element 9000W 230V heating circuits 3 ID $\varnothing$ 220mm ED $\varnothing$ 238mm L 282mm H 100mm L1 30mm W1 104mm H1 10mm H2 85mm flange length 147mm flange width 31mm hole distance 62mm connection male faston 6.3mm connection length 85mm tube $\varnothing$ 8.5mm convection heating element hole $\varnothing$ 4.5mm rectangular flange with gasket and silicone		



1

<b>GEV No.</b>	417564	<b>Ref. No.</b>	RS1180A0
<b>description</b>	heating element 9000W 230V heating circuits 3 ID $\varnothing$ 220mm ED $\varnothing$ 238mm L 282mm H 100mm L1 30mm W1 104mm H1 10mm H2 85mm flange length 147mm flange width 31mm hole distance 63mm connection male faston 6.3mm connection length 85mm tube $\varnothing$ 8.5mm convection heating element hole $\varnothing$ 4.5mm rectangular flange		
<b>For models:</b>	XVC1004P, XVC1204P		



1

<b>GEV No.</b>	417555	<b>Ref. No.</b>	KRS1020A RS1020A0
<b>description</b>	heating element 9000W 230V heating circuits 3 ID $\varnothing$ 240mm ED $\varnothing$ 257mm L 300mm H 100mm L1 38mm W1 104mm H1 8.5mm H2 85mm flange length 142mm flange width 25mm hole distance 126mm connection male faston 6.3mm connection length 85mm tube $\varnothing$ 8.5mm convection heating element hole $\varnothing$ 6.2mm rectangular flange INCOLOY-800		
<b>For models:</b>	XV1003G		



1

<b>GEV No.</b>	417547	<b>Ref. No.</b>	KRS1100A RS1100A0
<b>description</b>	heating element 90W 110V heating circuits 1 L 155mm W 31mm flange length 70mm flange width 22mm hole distance 56mm connection length 32mm connection male faston 6.3mm tube $\varnothing$ 6.35mm hole $\varnothing$ 5mm rectangular flange dry heating element		
<b>For models:</b>	XC595		

accessories

flange gaskets



1

<b>GEV No.</b>	550986	<b>Ref. No.</b>	GN1280 GN1327A0 GN224
<b>description</b>	gasket L 100mm W 22mm 7 holes graphite thickness 1mm for heating element		
<b>For models:</b>	XB403, XB403G, XB603, XB603G, XB803, XB803G, XBC404, XBC604, XBC804, XBT146, XBT160, XF023, XF043, XF090P, XF103, XF113, XF119, XF133, XF135, XF183, XF185, XF188, XF190, XF195, XV202, XV202E, XV203G, XV301, XV301E, XV303G, XV401, XV401E, XV501, XV501E, XV703G, XVC054, XVC104, XVC204, XVC304, XVC504, XVC704, XVT203G		



1

<b>GEV No.</b>	531270	<b>Ref. No.</b>	GN1086A
<b>description</b>	gasket L 141mm W 22mm D1 $\varnothing$ 10mm D2 $\varnothing$ 9mm 9 holes graphite thickness 1mm suitable for UNOX		
<b>For models:</b>	XVC1205EP, XVC2005EP, XVC305EP, XVC705EP		



 <p>1</p>			
<b>GEV No.</b>	531259	<b>Ref. No.</b>	GN1085A0 KGN1085A
<b>description</b>	gasket L 141mm W 22mm D1 ø 8mm D2 ø 9mm 9 holes graphite thickness 1mm suitable for UNOX		
<b>For models:</b>	XV1003G, XVC1004P, XVC1204P		

 <p>1</p>			
<b>GEV No.</b>	531258	<b>Ref. No.</b>	GN1326A
<b>description</b>	gasket L 72mm W 20mm 5 holes graphite thickness 1mm suitable for UNOX		
<b>For models:</b>	XB1083, XB693, XB695, XB893, XB895, XBC1005E, XBC1005EL, XBC405E, XBC605E, XBC905E, XBC905EL, XV1093, XV393, XV593, XV893, XVC055E, XVC1005EP, XVC1005EPL, XVC105E, XVC105EP, XVC1205EP, XVC2005EP, XVC205E, XVC305E, XVC305EP, XVC4005EP, XVC4005EPL, XVC505E, XVC505EP, XVC705E, XVC705EP, XVC905EP, XVC905EPL		

## energy regulators

### EGO

#### 1-circuit

 <p>1</p>			
<b>GEV No.</b>	380019	<b>Ref. No.</b>	KVE009 VE023
<b>description</b>	energy regulator 240V 13A single-circuit turn direction right shaft ø 6x4.6mm shaft L 23mm mounting thread M4 power release 6-100% no. 50.57071.010		

 <p>1</p>			
<b>GEV No.</b>	381243	<b>Ref. No.</b>	EX-VE023 KVE1556A
<b>description</b>	energy regulator 240V 13A single-circuit turn direction right shaft ø 6x4.6mm shaft L 23mm power release 6-100% with knob set		
<b>For models:</b>	XB1083, XB613G, XB693, XB813G, XB893, XF030, XF040, XF050, XF065, XV1093, XV201, XV202, XV301, XV393, XV401, XV501, XV513G, XV593, XV813G, XV893		

## thermostats

### control and safety thermostats

#### EGO

#### control thermostats

#### 55.10/19\_ series

 <p>1</p>			
<b>GEV No.</b>	390982	<b>Ref. No.</b>	KTR1141A TR022
<b>description</b>	thermostat 1NO probe ø 3.9mm probe L 127mm capillary pipe 1500mm shaft ø 6mm shaft L 23mm rotation 270°		
<b>For models:</b>	XL041, XL051, XL091, XL503		

 <p>1</p>			
<b>GEV No.</b>	390943	<b>Ref. No.</b>	KTR1100A TR1100A0
<b>description</b>	thermostat t.max. 269°C 1-pole 1NO 16A probe ø 3mm probe L 225mm capillary pipe 900mm capillary pipe isolated 800mm gland nut shaft ø 6x4.6mm shaft L 23mm shaft position upper rotation 270°		
<b>For models:</b>	XB693, XB893, XV593		



<b>GEV No.</b>	375894	<b>Ref. No.</b>	KTR001 KTR009 KTR012 KTR1130A TR006 TR006A
<b>description</b>	thermostat t.max. 293°C temperature range 55-293°C 1-pole 1NO 16A probe ø 3.1mm probe L 226mm capillary pipe 870mm capillary pipe isolated 350mm gland nut shaft ø 4.0-6.0mm shaft L 23mm rotation 270°		
<b>For models:</b>	XF003, XF006, XF011, XF016, XF023, XF030, XF030-TG, XF043, XF065, XF090P, XF113, XF133, XF183, XF193, XV202, XV301, XV401, XV501		



<b>GEV No.</b>	376024	<b>Ref. No.</b>	KTR006 KTR1131A TR016 TR017
<b>description</b>	thermostat t.max. 355°C temperature range 60-355°C 1-pole 1NO 16A probe ø 4mm probe L 228mm capillary pipe 900mm capillary pipe isolated 600mm gland nut shaft ø 6x4.6mm shaft L 23mm shaft position upper rotation°		
<b>For models:</b>	XP010P, XP010PR, XP010PT, XP010R, XP020, XP020P, XP020PR, XP020PT, XP020R, XP020T, XP250		

safety thermostats

55.32\_ series



<b>GEV No.</b>	390999	<b>Ref. No.</b>	KTR1140A TR007 TR008
<b>description</b>	safety thermostat switch-off temp. 350°C temperature range°C 2-pole NC 20A probe ø 3mm probe L 187mm capillary pipe 690mm capillary pipe isolated 680mm gland nut shaft ømm probe SS		
<b>For models:</b>	XF010, XF020, XF020R, XF030, XF040, XF043, XF050, XF065, XFT110, XFT113, XFT115, XFT119, XFT130, XFT133, XFT135, XFT140, XFT180, XFT183, XFT185, XV201		

CAEM

safety thermostats



<b>GEV No.</b>	375456	<b>Ref. No.</b>	KTR1134A KTR254 TR240 TR250
<b>description</b>	safety thermostat switch-off temp. 335°C 2-pole 20A probe ø 3mm probe L 200mm capillary pipe 1050mm capillary pipe isolated 650mm gland nut probe SS at 250V 20A at 400V 10A		
<b>For models:</b>	XCH030, XF003, XF006, XF010, XF011, XF016, XF020, XF020R, XF023, XF030, XF030-TG, XF040, XF043, XF050, XF065, XF090P, XF100, XF103, XF110, XF113, XF115, XF119, XF130, XF133, XF135, XF183, XP010P, XP010PR, XP010PT, XP010R, XP020, XP020P, XP020PR, XP020PT, XP020R, XP020T, XV201, XV202, XV202E, XV301, XV301E, XV401, XV401E, XV501, XV501E, XVC054, XVC104		

CAMPINI

safety thermostats

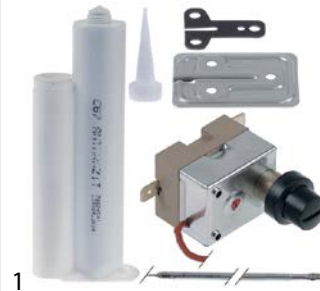

<b>GEV No.</b>	376080	<b>Ref. No.</b>	KTR1136A TR255B
<b>description</b>	safety thermostat kit switch-off temp. 318°C 1-pole 16A probe ø 3mm probe L 137mm capillary pipe 1260mm capillary pipe isolated 710mm gland nut probe SS type Ty 95-H		
<b>For models:</b>	XB403, XB403G, XB603, XB603G, XB803, XB803G, XBC404, XBC604, XBC605, XBC804, XBC805, XBC815G, XBT146, XBT160, XF185, XF188, XF190, XF193, XF195, XG413G, XG613, XG613G, XG813, XV1003G, XV203G, XV303G, XV703G, XVC1004P, XVC105, XVC1204P, XVC204, XVC304, XVC305, XVC504, XVC505, XVC514G, XVC515G, XVC704, XVC705, XVC715G, XVT203G		



1

<b>GEV No.</b>	375892	<b>Ref. No.</b>	KTR255B TR255A
<b>description</b>	safety thermostat switch-off temp. 318°C 1-pole 16A probe ø 3mm probe L 137mm capillary pipe 1260mm capillary pipe isolated 710mm gland nut probe SS type Ty 95-H		

switches and momentary switches

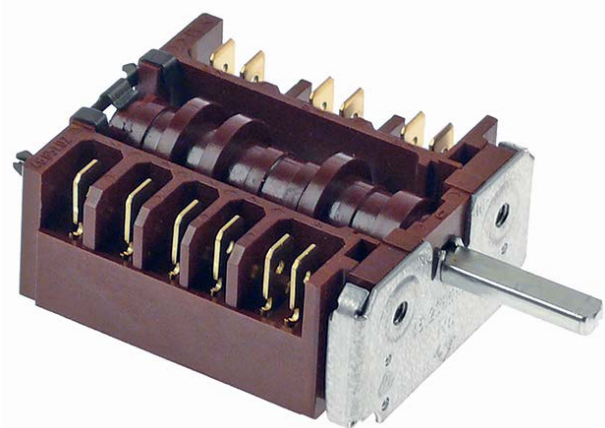

1

<b>GEV No.</b>	300251	<b>Ref. No.</b>	KVE0024A VE024
<b>description</b>	cam switch 6 operating positions 2NO/1CO 16A sequence 0-1-2-3-4-5 shaft ø 6x4.6mm shaft L 24mm connection male faston 6.3mm plastic 3-pole		
<b>For models:</b>	XF030, XF040, XF050, XF065		



1

<b>GEV No.</b>	345627	<b>Ref. No.</b>	VE1170A0
<b>description</b>	element holder mounting measurements 20.6x16.4mm black arched for push buttons 13x17mm		
<b>For models:</b>	XF003, XF103, XF113, XF133, XF183, XF193, XP010P, XP010PR, XP010PT, XP020, XP020P, XP020PR, XP020PT, XP020R, XP020T, XV593		



1

<b>GEV No.</b>	345537	<b>Ref. No.</b>	VE161
<b>description</b>	element holder mounting measurements 20.6x16.4mm light grey arched for push buttons 13x17mm		
<b>For models:</b>	XC110, XF006, XF011, XF016, XF030, XF030-TG, XF065, XF090P, XG413, XG413G, XG613, XG613G, XG813, XG813G, XL041, XL051, XL091, XL503, XP010P, XP010PR, XP010PT, XP010R, XP020, XP020P, XP020PR, XP020PT, XP020R, XP020T, XT010, XT020, XV202, XV301, XV401, XV501		



1

<b>GEV No.</b>	357224	<b>Ref. No.</b>	KVM2009A VM2009A0
<b>description</b>	element holder mounting measurements 20.6x16.4mm silver arched for push buttons 13x17mm		
<b>For models:</b>	XB693, XB893		

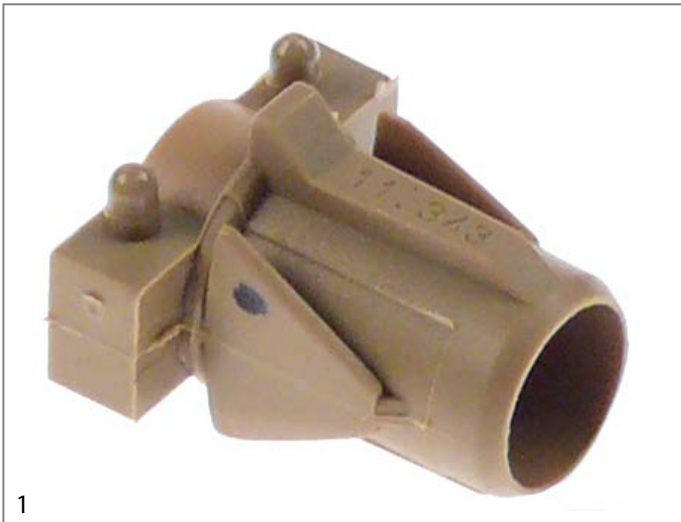

1

<b>GEV No.</b>	345601	<b>Ref. No.</b>	KVM1762A VE162 VM1762A0
<b>description</b>	indicator lamp holder V ø 11mm		
<b>For models:</b>	XB1083, XB613G, XB693, XB813G, XB893, XC110, XF003, XF006, XF011, XF016, XF030, XF030-TG, XF065, XF090P, XF103, XF113, XF133, XF183, XF193, XFT113, XFT133, XFT183, XFT193, XG413, XG413G, XG613, XG613G, XG813, XG813G, XL041, XL051, XL091, XL413, XL503, XP010E, XP010ER, XP010ET, XP010P, XP010PR, XP010PT, XP010R, XP020, XP020E, XP020ER, XP020ET, XP020P, XP020PR, XP020PT, XP020R, XP020T...(Other models you can see in the webshop)		



1

<b>GEV No.</b>	357012	<b>Ref. No.</b>	KVE007
<b>description</b>	indicator lamps set mounting measurements 20.6x16.4mm green 230V connection male faston 6.3mm ø 20.6x16.4mm socket male faston 6.3mm		



1

<b>GEV No.</b>	357120	<b>Ref. No.</b>	KVE008
<b>description</b>	indicator lamps set mounting measurements 20.6x16.4mm 230V		



1

<b>GEV No.</b>	301308	<b>Ref. No.</b>	KVE0007A
<b>description</b>	indicator lamps set mounting measurements 20.6x16.4mm green/white 230V connection male faston 6.3mm		





1

<b>GEV No.</b>	301307	<b>Ref. No.</b>	KLP1014A
<b>description</b>	indicator lamps set mounting measurements 20.6x16.4mm white 230V connection male faston 6.3mm		



1

<b>GEV No.</b>	360598	<b>Ref. No.</b>	KVE1535A VE1535A0 VE177
<b>description</b>	indicator light LED white connection male faston 6.3mm 250V ø 11mm voltage AC		
<b>For models:</b>	XB693, XB893, XC110, XF003, XF006, XF011, XF016, XF030, XF030-TG, XF065, XF090P, XF103, XF113, XF133, XF183, XF193, XG413, XG413G, XG613, XG613G, XG813, XG813G, XL041, XL051, XL091, XL503, XP010P, XP010PR, XP010PT, XP010R, XP020, XP020P, XP020PR, XP020PT, XP020R, XP020T, XV202, XV301, XV401, XV501, XV593		
<b>accessories for</b>	360598		
	<b>GEV No.</b>	345601	<b>Ref. No.</b>
			KVM1762A VE162 VM1762A VM1762A0
	indicator lamp holder V ø 11mm		



1

<b>GEV No.</b>	357223	<b>Ref. No.</b>	VE1585A0
<b>description</b>	indicator light lens size 17x13mm blue Sinus gold		
<b>For models:</b>	XB693, XB893, XV593		



1

<b>GEV No.</b>	357226	<b>Ref. No.</b>	VE1530A0
<b>description</b>	indicator light lens size 17x13mm blue thermometer gold		
<b>For models:</b>	XB693, XB893, XP010P, XP010PR, XP010PT, XP020, XP020P, XP020PR, XP020PT, XP020R, XP020T, XV593		



1

<b>GEV No.</b>	346811	<b>Ref. No.</b>	VE163
<b>description</b>	indicator light lens size 17x13mm green		
<b>For models:</b>	XC110, XF065		



1

<b>GEV No.</b>	347749	<b>Ref. No.</b>	VE167
<b>description</b>	indicator light lens size 17x13mm green crossed out flame gold		
<b>For models:</b>	XG413, XG413G, XG613, XG613G, XG813, XG813G		



1

<b>GEV No.</b>	347747	<b>Ref. No.</b>	VE166
<b>description</b>	indicator light lens size 17x13mm green steam gold		
<b>For models:</b>	XF090P, XV202, XV301, XV401, XV501		



1

<b>GEV No.</b>	347748	<b>Ref. No.</b>	VE165
<b>description</b>	indicator light lens size 17x13mm green Sinus gold		
<b>For models:</b>	XF011, XF030, XF030-TG, XF065, XF090P, XV202, XV301, XV401, XV501		



1

<b>GEV No.</b>	347746	<b>Ref. No.</b>	VE164
<b>description</b>	indicator light lens size 17x13mm green thermometer gold		
<b>For models:</b>	XF003, XF006, XF011, XF016, XF030, XF030-TG, XF065, XF090P, XF103, XF113, XF133, XF183, XF193, XL041, XL051, XL091, XL503, XP010P, XP010PR, XP010PT, XP010R, XP020, XP020P, XP020PR, XP020PT, XP020R, XP020T, XV202, XV301, XV401, XV501		



1

<b>GEV No.</b>	348007	<b>Ref. No.</b>	VE1030A1
<b>description</b>	magnet ø 23mm Lmm H 10mm Wmm ID ø 4.5mm ED ø 23mm M3 hole ø 4.5mm		
<b>For models:</b>	XB403, XB403G, XB603, XB603G, XB803, XB803G, XB895, XBC1005, XBC404, XBC604, XBC605, XBC804, XBC805, XBC815G, XBT146, XBT160, XG413G, XG613, XG613G, XG813, XV1003G, XV203G, XV303G, XV703G, XVC1004P, XVC1005P, XVC1015G, XVC1204P, XVC2015G, XVC204, XVC205, XVC304, XVC305, XVC315G, XVC504, XVC505, XVC514G, XVC515G, XVC704, XVC705, XVC715G, XVC905P		



1

<b>GEV No.</b>	301306	<b>Ref. No.</b>	KVE0106A VE0106A0
<b>description</b>	momentary push switch mounting measurements 20,6x16,4mm silver 1NO 250V 16A reset connection male faston 6.3mm ambient temperature max. 150°C protection IP40		

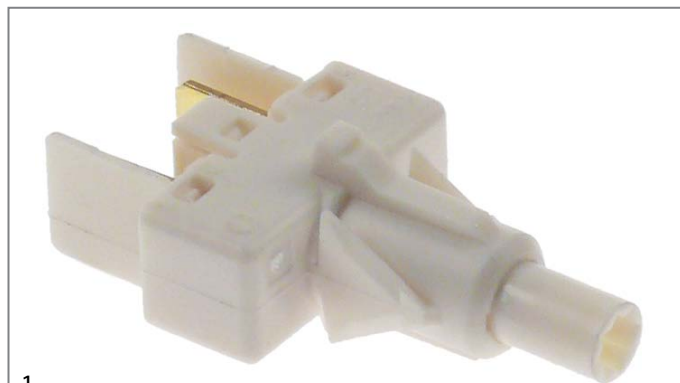

1

<b>GEV No.</b>	347193	<b>Ref. No.</b>	VE169
<b>description</b>	momentary switch unit 1NO 250V 16A connection male faston 6.3mm		
<b>For models:</b>	XF090P, XF113, XF133, XG413, XG413G, XG613, XG613G, XG813, XG813G, XL041, XL091, XL503		



1

<b>GEV No.</b>	347945 <sup>1</sup>	<b>Ref. No.</b>	KVE1295A MF09 VE086 VE086B
<b>description</b>	microswitch with plunger thread M10 thread L 13mm 250V 5A 1CO connection male faston 6.3mm stroke 6mm mounting distance 25mm L 49mm L1 13mm ambient temperature max. 85°C IP65 type MKH12D09 actuating force: 340g		
<b>For models:</b>	XF043, XF090P, XF100, XF110, XF115, XF130, XF135, XF183, XF185, XF188, XF190, XF193, XF195, XV201, XV202, XV202E, XV301, XV301E, XV401, XV401E, XV501, XV501E, XVC054, XVC104		

<sup>1</sup>protection class IP65



1

<b>GEV No.</b>	347751	<b>Ref. No.</b>	VE176
<b>description</b>	push button size 17x13mm silver 0-I gold		
<b>For models:</b>	XC110, XL041, XL051, XL091, XL503, XP010P, XP010PR, XP010PT, XP010R, XP020, XP020P, XP020PR, XP020PT, XP020R, XP020T, XT010, XT020		



1

<b>GEV No.</b>	347752	<b>Ref. No.</b>	VE174
<b>description</b>	push button size 17x13mm silver crossed out flame gold		
<b>For models:</b>	XG413, XG413G, XG613, XG613G, XG813, XG813G		



1

<b>GEV No.</b>	347750	<b>Ref. No.</b>	VE175
<b>description</b>	push button size 17x13mm silver steam gold		
<b>For models:</b>	XF090P, XF113, XF133, XL041, XL091, XL503		



1

<b>GEV No.</b>	348032	<b>Ref. No.</b>	KVM2007A VM2007A0
<b>description</b>	push button size 17x13mm silver fan speed black		
<b>For models:</b>	XB693, XB893, XV593		



1

<b>GEV No.</b>	348186	<b>Ref. No.</b>	KVE0108A
<b>description</b>	push switch mounting measurements 20,6x16,4mm 2NO 250V 16A 0-1 connection male faston 6.3mm		



			
1			
<b>GEV No.</b>	348006	<b>Ref. No.</b>	KVE002 KVE1020A KVE1020B VE1020A0 VE1020A1
<b>description</b>	Read switch kit thread M10x0.75 1NO 250V 0.04A connection male faston 6.3mm cable length 1200mm type D10P 1V DA F 120 with magnet		
<b>For models:</b>	XB403, XB403G, XB603, XB603G, XB803, XB803G, XBC1005, XBC404, XBC604, XBC605, XBC804, XBC805, XBC815G, XBT146, XBT160, XG413, XG413G, XG613, XG613G, XG813, XG813G, XK304, XV1003G, XV203G, XV303G, XV703G, XVC1004P, XVC1005P, XVC1015G, XVC1204P, XVC2015G, XVC204, XVC205, XVC304, XVC305, XVC315G, XVC504, XVC505, XVC514G, XVC515G, XVC704, XVC705, XVC715G, XVC905P, XVT203G		

			
1			
<b>GEV No.</b>	345720	<b>Ref. No.</b>	VE168
<b>description</b>	switch 2NO 250V 16A connection male faston 6.3mm		
<b>For models:</b>	XC110, XL041, XL051, XL091, XL503, XP010P, XP010PR, XP010PT, XP010R, XP020, XP020P, XP020PR, XP020PT, XP020R, XP020T, XT010, XT020		

## lamps

### indicator lights

#### indicator lights (complete)

20.6x16.4mm

			
1			
<b>GEV No.</b>	348031	<b>Ref. No.</b>	KLP1012A
<b>description</b>	indicator light mounting measurements 20.6x16.4mm blue 230V connection male faston 6.3mm oval Qty 2 temp.-resist. 150°C temperature		

miscellaneous			
			
1			
<b>GEV No.</b>	357120	<b>Ref. No.</b>	KVE008
<b>description</b>	indicator lamps set mounting measurements 20.6x16.4mm 230V		

			
1			
<b>GEV No.</b>	357012	<b>Ref. No.</b>	KVE007
<b>description</b>	indicator lamps set mounting measurements 20.6x16.4mm green 230V connection male faston 6.3mm ø 20.6x16.4mm socket male faston 6.3mm		

			
1			
<b>GEV No.</b>	301308	<b>Ref. No.</b>	KVE0007A
<b>description</b>	indicator lamps set mounting measurements 20.6x16.4mm green/white 230V connection male faston 6.3mm		

			
1			
<b>GEV No.</b>	301307	<b>Ref. No.</b>	KLP1014A
<b>description</b>	indicator lamps set mounting measurements 20.6x16.4mm white 230V connection male faston 6.3mm		

## LED

### LED bars

			
1			
<b>GEV No.</b>	357231	<b>Ref. No.</b>	KLP1001B
<b>description</b>	LED bar L 300mm W 18mm H 19mm		
<b>For models:</b>	XBC405E, XVC305E, XVC305EP, XVC315EG		

screw-on/push-on fit

halogen lamp

for socket G4 / G6.35 / G9



<b>GEV No.</b>	359946	<b>Ref. No.</b>	VE1005A1
<b>description</b>	halogen lamp socket G9 230V 40W temp.-resist. 300°C 560lm 2000		
<b>For models:</b>	XB403, XB403G, XB603, XB603G, XB803, XB803G, XBC404, XBC604, XBC804, XBT146, XBT160, XF100, XF110, XF113, XF119, XF130, XF135, XF183, XF185, XF188, XF190, XF193, XF195, XG413G, XG613G, XG813, XV1003G, XV203G, XV303G, XV703G, XVC054, XVC104, XVC204, XVC304, XVC504, XVC704		

oven lamps



universal oven lamps

mounting diameter 35.5mm







<b>GEV No.</b>	357119	<b>Ref. No.</b>	KVE028 VE030
<b>description</b>	oven lamp mounting ø 35.5mm 230V 15W socket E14 round temp.-resist. 300°C no lens nipple		
<b>For models:</b>	XF010, XF011, XF020, XF020R, XF030, XF030-TG, XF040, XF050, XF065, XF090P, XF103, XV202, XV202E, XV301, XV301E, XV401, XV401E, XV501, XV501E		



<b>GEV No.</b>	359718	<b>Ref. No.</b>	KLP0030A
<b>description</b>	oven lamp mounting ø 35.5mm 230V 15W socket E14 temp.-resist. 300°C connection male faston 6.3mm hard glas		
<b>spare parts for</b>	359718		
	<b>GEV No.</b>	359701	<b>Ref. No.</b> VE1015
	lamp socket socket E14 220-230V mounting ø 35.5mm connection male faston 6.3mm 15W		
	<b>GEV No.</b>	359740	<b>Ref. No.</b> —
	light bulb t.max. 300°C socket E14 15W 230V ø 22mm L 48mm lens L 20mm for oven lamp IMPORT 70lm 1000		



<b>GEV No.</b>	360753	<b>Ref. No.</b>	KVE1480A KVT1235A VT1200A
<b>description</b>	oven lamp mounting ø 35mm 230V 25W socket G9		

<b>GEV No.</b>	359701	<b>Ref. No.</b>	VE1015
<b>description</b>	lamp socket socket E14 220-230V mounting ø 35.5mm connection male faston 6.3mm 15W		
<b>accessories for</b>	359701		
	<b>GEV No.</b>	359705	<b>Ref. No.</b> VE1010A1
	oven lamp glass thr.ø 33.5mm ø 52mm hard glas temp.-resist. 350°C		
	<b>GEV No.</b>	359709	<b>Ref. No.</b> VE036
	oven lamp glass thr.ø 33.5mm ø 42mm hard glas temp.-resist. 350°C		
	<b>GEV No.</b>	359721	<b>Ref. No.</b> —
	gasket silicone ED ø 48mm ID ø 39.5mm thickness 5mm Qty 1 pcs		
	<b>GEV No.</b>	359942	<b>Ref. No.</b> —
	oven lamp glass thr.ø 33.5mm H 39mm ø 40mm hard glas temp.-resist. 350°C		

<b>GEV No.</b>	357160	<b>Ref. No.</b>	KVE1015A VE1015A0 VE1015A1
<b>description</b>	lamp socket socket G9 220-230V mounting ø 35.5mm connection cable 100mm		
<b>For models:</b>	XB403, XB403G, XB603, XB603G, XB693, XB695, XB803, XB803G, XB893, XB895, XBC404, XBC604, XBC804, XBT146, XBT160, XF100, XF110, XF113, XF115, XF119, XF130, XF133, XF135, XF183, XF185, XF188, XF190, XF193, XF195, XG413, XG413G, XG613, XG613G, XG813, XG813G, XV1003G, XV203G, XV303G, XV593, XV703G, XVC054, XVC104, XVC1204P, XVC204, XVC304, XVC504, XVC514G, XVC704, XVT203G		

<b>GEV No.</b>	359709	<b>Ref. No.</b>	VE036
<b>description</b>	oven lamp glass thr.ø 33.5mm ø 42mm hard glas temp.-resist. 350°C		
<b>For models:</b>	XF010, XF020, XF020R, XF030, XF040, XF050, XF065, XF183, XF193, XV201		



			
1			
<b>GEV No.</b>	359705	<b>Ref. No.</b>	VE1010A1
<b>description</b>	oven lamp glass thr.ø 33.5mm ø 52mm hard glas temp.-resist. 350°C		
<b>For models:</b>	XB603, XBC404, XBC604, XBC804, XF090P, XF113, XG813, XV1003G, XVC304, XVC504, XVC514G		
<b>accessories for</b>	359705		
	<b>GEV No.</b>	359610	<b>Ref. No.</b> —
	light bulb t.max. 300°C socket E14 15W 230V ø 22mm L 47mm lens L 20mm for oven lamp type Philips		
	<b>GEV No.</b>	359700	<b>Ref. No.</b> —
	gasket for pizza oven fibre glass ID ø 32.5mm ED ø 55mm thickness 5mm		
	<b>GEV No.</b>	359721	<b>Ref. No.</b> —
	gasket silicone ED ø 48mm ID ø 39.5mm thickness 5mm Qty 1 pcs		
	<b>GEV No.</b>	359837	<b>Ref. No.</b> —
	gasket ID ø 33mm ED ø 46mm thickness 1mm graphite		
	<b>GEV No.</b>	359838	<b>Ref. No.</b> —
	gasket ID ø 33mm ED ø 45mm		

			
1			
<b>GEV No.</b>	358136	<b>Ref. No.</b>	GN1005 KVE005 KVT1195A VE1005 VE1005A0 VE1010A0
<b>description</b>	repair kit ø 35.5mm for oven lamp		
<b>For models:</b>	XB403, XB403G, XB603, XB603G, XB803, XB803G, XBT146, XBT160, XF100, XF110, XF115, XF119, XF130, XF135, XF185, XF188, XF190, XF195, XG413, XG413G, XG613, XG613G, XG813, XG813G, XV1003G, XV203G, XV303G, XV703G, XVC054, XVC1004P, XVC104, XVC204, XVC304, XVC504, XVC704, XVT203G		

lamps



halogen lamps



for socket G4 / G6.35 / G9

			
1			
<b>GEV No.</b>	359946	<b>Ref. No.</b>	VE1005A1
<b>description</b>	halogen lamp socket G9 230V 40W temp.-resist. 300°C 560lm 2000		
<b>For models:</b>	XB403, XB403G, XB603, XB603G, XB803, XB803G, XBC404, XBC604, XBC804, XBT146, XBT160, XF100, XF110, XF113, XF119, XF130, XF135, XF183, XF185, XF188, XF190, XF193, XF195, XG413G, XG613G, XG813, XV1003G, XV203G, XV303G, XV703G, XVC054, XVC104, XVC204, XVC304, XVC504, XVC704		

			
1			
<b>GEV No.</b>	358135 <sup>1</sup>	<b>Ref. No.</b>	GN1065+GN1055 GN1065A GN1065A1 GN192 KGN1065A KGN1065A1
<b>description</b>	gasket for oven lamp PTFE ID ø 44mm ED ø 53mm thickness 3mm with silicone O-ring		
<b>For models:</b>	XB603, XB613G, XB693, XB695, XB813G, XB893, XB895, XBC404, XBC604, XBC804, XBC815G, XF113, XF119, XF133, XF135, XFT110, XFT113, XFT115, XFT119, XFT130, XFT133, XFT135, XFT140, XFT180, XFT183, XFT185, XFT188, XFT190, XFT193, XFT195, XFT199, XFT200, XG413G, XG813, XV1003G, XV393, XV513G, XV593, XV813G, XV893, XVC054, XVC104, XVC1204P, XVC204, XVC304, XVC504, XVC514G, XVC704		

<sup>1</sup>with silicone O-ring

			
1			
<b>GEV No.</b>	358191	<b>Ref. No.</b>	KVE1005A
<b>description</b>	repair kit ID ø 44mm ED ø 53mm thickness 3mm for oven lamp		
<b>For models:</b>	XB613G, XB693, XB695, XB813G, XB893, XB895, XFT110, XFT113, XFT115, XFT119, XFT130, XFT133, XFT135, XFT140, XFT180, XFT183, XFT185, XFT188, XFT190, XFT193, XFT195, XFT199, XFT200, XV393, XV513G, XV593, XV813G, XV893		
<b>spare parts for</b>	358191		
	<b>GEV No.</b>	357195	<b>Ref. No.</b> —
	halogen lamp socket G9 230V 25W temp.-resist. 300°C OSRAM HALOPIN OVEN		
	<b>GEV No.</b>	358135	<b>Ref. No.</b>
	gasket for oven lamp PTFE ID ø 44mm ED ø 53mm thickness 3mm with silicone O-ring		

			
1			
<b>GEV No.</b>	358191	<b>Ref. No.</b>	KVE1005A
<b>description</b>	repair kit ID ø 44mm ED ø 53mm thickness 3mm for oven lamp		
<b>For models:</b>	XB613G, XB693, XB695, XB813G, XB893, XB895, XFT110, XFT113, XFT115, XFT119, XFT130, XFT133, XFT135, XFT140, XFT180, XFT183, XFT185, XFT188, XFT190, XFT193, XFT195, XFT199, XFT200, XV393, XV513G, XV593, XV813G, XV893		
<b>spare parts for</b>	358191		
	<b>GEV No.</b>	357195	<b>Ref. No.</b> —
	halogen lamp socket G9 230V 25W temp.-resist. 300°C OSRAM HALOPIN OVEN		
	<b>GEV No.</b>	358135	<b>Ref. No.</b>
	gasket for oven lamp PTFE ID ø 44mm ED ø 53mm thickness 3mm with silicone O-ring		



## timers

## programme timers



1

<b>GEV No.</b>	360703	<b>Ref. No.</b>	KVE1555A
<b>description</b>	timer CDC 8802F1 engines 1 chambers 2 operation time 4min 230V 50Hz shaft ømm shaft Lmm manuf. no. 8802F10AGE000.0010 motor type M48R 230V		

## mechanical timers



1

<b>GEV No.</b>	350134 <sup>1</sup>	<b>Ref. No.</b>	KTM001 KTM0023A
<b>description</b>	time switch kit M2 2-pole operation time 120min impulse mechanical 2CO at 250V 16A permanent position yes shaft ø 6x4.6mm shaft 6x4.6mm shaft L 22mm mounting distance 28mm ambient temperature max. 125°C with knob		

<sup>1</sup>incl. knob and symbol

1

<b>GEV No.</b>	350184	<b>Ref. No.</b>	KTM003
<b>description</b>	timer M2 2-pole operation time 120min impulse mechanical 2CO at 250V 16A permanent position yes shaft ø 6x4.6mm shaft 6x4.6mm shaft L 23mm mounting distance 28mm		



1

<b>GEV No.</b>	350186	<b>Ref. No.</b>	MIN042 TM023
<b>description</b>	timer M2 2-pole operation time 120min impulse mechanical 2CO at 250V 16A permanent position yes shaft ø 6x4.6mm shaft 6x4.6mm shaft L 23mm mounting distance 28mm		
<b>For models:</b>	XF006, XF011, XF016, XF030, XF030-TG, XF090P, XF103, XF113, XF133, XF183, XF193		
<b>accessories for</b>	350186		



<b>GEV No.</b>	112627	<b>Ref. No.</b>	MN1000A + MN1050A MN1000A0
knob time 120min ø 58mm shaft ø 6x4.6mm shaft flat lower			



1

<b>GEV No.</b>	350185 <sup>1</sup>	<b>Ref. No.</b>	KTM005
<b>description</b>	timer M2 2-pole operation time 60min impulse mechanical 2CO at 250V 16A permanent position yes shaft 6x4.6mm shaft L 23mm mounting distance 28mm		

<sup>1</sup>incl. knob

1

<b>GEV No.</b>	350187	<b>Ref. No.</b>	KTM004 KTM1005A TM1005A0
<b>description</b>	timer M2 2-pole operation time 60min impulse mechanical 2CO at 250V 16A permanent position yes shaft ø 6x4.6mm shaft 6x4.6mm shaft L 23mm mounting distance 28mm		
<b>For models:</b>	XB1083, XB613G, XB693, XB813G, XB893, XF003, XF023, XF043, XF113, XF133, XFT113, XFT133, XFT183, XFT193, XV1093, XV393, XV513G, XV593, XV813G, XV893		

## alarm devices

## buzzer boards



1

<b>GEV No.</b>	401062	<b>Ref. No.</b>	KTM0012B KTM012B
<b>description</b>	buzzer board 230VAC L 48mm W 45mm connection male faston 6.3mm		



1

<b>GEV No.</b>	403761	<b>Ref. No.</b>	VE1070A VE1070A0
<b>description</b>	buzzer board 230VAC L 54mm W 31mm connection male faston 6.3mm suitable for UNOX		
<b>For models:</b>	XG413, XG413G, XG613, XG613G, XG813, XG813G		





			
1			
<b>GEV No.</b>	350210	<b>Ref. No.</b>	KTM1001C TM1001C0
<b>description</b>	buzzer board L 54mm W 48mm connection male faston 6.3mm		

## contactors

### GENERAL ELECTRIC (AEG)

#### power contactors

			
1			
<b>GEV No.</b>	381242	<b>Ref. No.</b>	KVE1115A VE1115A0
<b>description</b>	power contactor resistive load 20A 230VAC (AC3/400V) 8.4A/4kW main contacts 4NO connection screw connection type AEG LS05 400A type GE MC1A 400A with mounting clips		
<b>For models:</b>	XB1083, XB613G, XB693, XB813G, XB893, XBC1005, XBC1005E, XBC1005EL, XBC1015EG, XBC1015EGL, XBC405E, XBC605, XBC605E, XBC805, XBC805E, XBC905E, XBC905EL, XBC915EG, XBC915EGL, XF043, XF100, XF103, XF110, XF115, XF119, XF130, XF135, XFT110, XFT113, XFT115, XFT119, XFT130, XFT135, XFT140, XFT180, XFT183, XFT185, XFT188, XFT190, XFT193, XFT195, XFT199, XFT200, XV1093, XV393, XV513G, XV593, XV813G, XV893, XVC054...(Other models you can see in the webshop)		

			
1			
<b>GEV No.</b>	381095	<b>Ref. No.</b>	KVE019 KVE1095A VE1095A0
<b>description</b>	power contactor resistive load 25A 230VAC (AC3/400V) 12A/5.5kW main contacts 3NO auxiliary contacts 1NO connection screw connection type AEG type GE CL01A400T6		
<b>For models:</b>	XB403, XB403G, XB603, XB603G, XB693, XB695, XB803, XB803G, XB893, XB895, XBC404, XBC604, XBC804, XBT146, XBT160, XF183, XF185, XF188, XF190, XF193, XF195, XV1003G, XV203G, XV303G, XV593, XV703G, XVC1004P, XVC1204P, XVC204, XVC304, XVC504, XVC704, XVT203G		

## SIEMENS

#### power contactors

			
1			
<b>GEV No.</b>	380526	<b>Ref. No.</b>	VE208
<b>description</b>	power contactor resistive load 20A 230VAC (AC3/400V) 8.4A/4kW main contacts 4NO auxiliary contacts connection screw connection type 3TG10-10-0A2L2		
<b>For models:</b>	XB403, XB403G, XB603, XB603G, XB803, XB803G, XF090P, XV202, XV202E, XV203G, XV301, XV301E, XV303G, XV401, XV401E, XV501, XV501E, XV703G		

## miscellaneous

#### accessories

			
1			
<b>GEV No.</b>	381096	<b>Ref. No.</b>	KVM1075A VM1075A0 VM1075A1
<b>description</b>	clip for contactor		
<b>For models:</b>	XB693, XB695, XB893, XB895, XBC1005, XBC404, XBC604, XBC605, XBC804, XF043, XF119, XF135, XF183, XF185, XF190, XF193, XVC054, XVC1005P, XVC1015G, XVC104, XVC105, XVC1204P, XVC2015G, XVC204, XVC205, XVC304, XVC305, XVC504, XVC505, XVC704, XVC705, XVC905P		

## transformers

### open transformers

#### with clamp terminal

			
1			
<b>GEV No.</b>	403470	<b>Ref. No.</b>	KVE1360A VE1360A0
<b>description</b>	transformer primary 120/240VAC secondary 12VAC 60VA secondary 5A connection male faston 6.3mm 50-60Hz		
<b>For models:</b>	XBC1005, XBC605, XBC805, XBC815G, XVC1005P, XVC2015G, XVC205, XVC305, XVC505, XVC705, XVC715G, XVC905P		



encapsulated transformers

PMA



1			
<b>GEV No.</b>	379054	<b>Ref. No.</b>	TR102
<b>description</b>	transformer primary 230VAC secondary 12VAC 3VA secondary 0.25A H 40mm L 45mm W 50mm connection screw 50/60Hz type 153/M		

1			
<b>GEV No.</b>	378543	<b>Ref. No.</b>	KTR004 TR1005/KTR004
<b>description</b>	temperature probe Pt100 cable glass fibre probe -40 up to +350°C cable -40 up to +260°C connection male faston 6.3mm thread M10x1 probe ø4x14-100mm cable length 0.65m		

electronic controllers

SHANGFANG

accessories



1			
<b>GEV No.</b>	379054	<b>Ref. No.</b>	TR102
<b>description</b>	transformer primary 230VAC secondary 12VAC 3VA secondary 0.25A H 40mm L 45mm W 50mm connection screw 50/60Hz type 153/M		

1			
<b>GEV No.</b>	378542	<b>Ref. No.</b>	TR0110A TR110
<b>description</b>	temperature probe Pt100 cable PTFE probe -100 up to 450°C cable -40 up to +250°C connection plug thread probe ø3x70mm cable length 1.4m		
<b>For models:</b>	XV202E, XV301E, XV401E, XV501E		

probes

producer-specific probes

probes



1			
<b>GEV No.</b>	379741	<b>Ref. No.</b>	KTR007 KTR1095A TR1015A0
<b>description</b>	temperature probe kit NTC cable glass fibre probe -40 up to +125°C cable -50 up to +350°C connection coded plug thread probe ø4x-19mm cable length 1m		
<b>For models:</b>	XC314, XC595, XCH030, XF100, XF110, XF115, XF119, XF130, XF135, XF185, XF188, XF190, XF195, XL135, XL195, XL314, XL404		
<b>accessories for</b>	379741		
	<b>GEV No.</b>	890034	<b>Ref. No.</b> —
	silicone adhesive TOMABOND TB77 cartridge 80ml anthracite		

1			
<b>GEV No.</b>	378374 <sup>1</sup>	<b>Ref. No.</b>	KTR1105A TR1105A0
<b>description</b>	temperature probe PTC cable silicone probe -50 up to +150°C cable -50 up to +180°C connection coded plug thread probe ø4x16mm cable length 1m		
<b>For models:</b>	XBC605, XBC805, XBC815G, XL405, XVC105, XVC205, XVC305, XVC315G, XVC505, XVC515G, XVC705, XVC715G		

<sup>1</sup>incl. silicone gasket

1			
<b>GEV No.</b>	378415	<b>Ref. No.</b>	KTR1110A
<b>description</b>	temperature probe thermocouple K (NiCr-Ni) cable PTFE probe -50 up to 1150°C cable -40 up to +250°C connection plug thread probe ø6x180mm cable length 2m		



<b>GEV No.</b>	378660	<b>Ref. No.</b>	KTR1106A
<b>description</b>	temperature probe kit for cavity probe $\varnothing$ 4x25mm cable length 2m flange 20x12mm with mounting kit silicone adhesive C67		
<b>For models:</b>	XBC1005E, XBC1005EL, XBC1015EG, XBC1015EGL, XBC405E, XBC605E, XBC615EG, XBC805E, XBC815EG, XBC905E, XBC905EL, XBC915EG, XBC915EGL, XVC1005EP, XVC1005EPL, XVC1015EG, XVC1015EGL, XVC1205EP, XVC1215EG, XVC2005EP, XVC2015EG, XVC315EG, XVC4005EP, XVC4005EPL, XVC4015EG, XVC4015EGL, XVC515EG, XVC715EG, XVC905EP, XVC905EPL, XVC915EG, XVC915EGL		
<b>spare parts for</b>	378660		
	<b>GEV No.</b>	890034	<b>Ref. No.</b> —
	silicone adhesive TOMABOND TB77 cartridge 80ml anthracite		



<b>GEV No.</b>	378366	<b>Ref. No.</b>	KTR1045A TR1045A0
<b>description</b>	temperature probe kit NTC cable glass fibre probe -40 up to +125°C cable -50 up to +350°C connection plug thread probe $\varnothing$ 4x19mm cable length 1m		
<b>For models:</b>	XBC404, XBC604, XBC804, XVC054, XVC1004P, XVC104, XVC204, XVC304, XVC504, XVC704		



<b>GEV No.</b>	378297	<b>Ref. No.</b>	TR1005A TR1005A0
<b>description</b>	temperature probe kit Pt100 cable glass fibre probe -100 up to 450°C cable -100 up to 450°C connection F6.3 thread M10 probe $\varnothing$ 4x14-100mm cable length 0.65m		
<b>For models:</b>	XBT146, XBT160, XG413, XG413G, XG613, XG613G, XG813, XG813G, XV1003G, XVT203G		

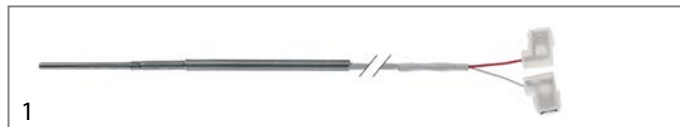

<b>GEV No.</b>	378371 <sup>1</sup>	<b>Ref. No.</b>	KTR0110A
<b>description</b>	temperature probe kit Pt100 cable PTFE probe -100 up to 450°C cable -40 up to +250°C connection plug thread probe $\varnothing$ 3x70mm cable length 1.4m		

<sup>1</sup>incl. silicone gasket

core probes

<b>GEV No.</b>	378417	<b>Ref. No.</b>	KSN1002A SN1002A0
<b>description</b>	core temperature probe Pt100 cable PTFE probe -40 up to +250°C cable -40 up to +250°C connection 5-wire probe $\varnothing$ 4x100mm thread M10 cable length 2m handle $\varnothing$ 12mm handle length 52mm		
<b>For models:</b>	XVC1015G, XVC2015G		

<b>GEV No.</b>	379709	<b>Ref. No.</b>	KTR003 KTR1000A TR0123A0 TR1000A0 TR1000A3 TR123
<b>description</b>	core temperature probe Pt100 cable PTFE probe -40 up to +250°C cable -40 up to +250°C connection male faston 6.3mm probe $\varnothing$ 4x100mm thread M10 cable length 1.4m handle $\varnothing$ 12mm handle length 85mm		
<b>For models:</b>	XB403G, XB603G, XB803G, XCH030, XG413G, XG613G, XG813G, XV203G, XV303G, XV703G, XVT203G		



			
1			
<b>GEV No.</b>	378373	<b>Ref. No.</b>	KSN1000A SN1000A0
<b>description</b>	core temperature probe Pt100 cable PTFE probe -40 up to +250°C cable -40 up to +250°C connection plug probe ø4x100mm thread M10 cable length 1.5m handle ø 12mm handle length 52mm		
<b>For models:</b>	XVC315G		

			
1			
<b>GEV No.</b>	379705	<b>Ref. No.</b>	KTR1040A TR1040A0 TR1040A1
<b>description</b>	core temperature probe Pt100 cable PVC probe -40 up to +120°C cable -10 up to +100°C connection plug probe ø4x100mm thread M10x1.5 cable length 1.28m		
<b>For models:</b>	XBC404, XVC054, XVC104, XVC105, XVC204, XVC205, XVC304, XVC305		

			
1			
<b>GEV No.</b>	378365	<b>Ref. No.</b>	KTR1041A TR1041A2
<b>description</b>	core temperature probe Pt100 cable PVC probe -40 up to +120°C cable -40 up to +120°C connection plug probe ø4x100mm thread M10x1.5 cable length 2m handle length 44mm		

### Hall sensors

			
1			
<b>GEV No.</b>	403435	<b>Ref. No.</b>	KPE1710A KPE1710B PE1710A1
<b>description</b>	Hall sensor L 38mm W 8mm H 4mm mounting distance 34mm cable length 1000mm		
<b>For models:</b>	XVC1015G, XVC315G		

### accessories

#### fasteners

			
1			
<b>GEV No.</b>	378418	<b>Ref. No.</b>	VI1515A1
<b>description</b>	bracket for core temperature probe L 30mm W 30mm H 15mm SS 18/10		
<b>For models:</b>	XB403G, XB603G, XB803G, XBC1005, XBC404, XBC604, XBC804, XCH030, XG413G, XG613G, XV1003G, XV203G, XV303G, XV703G, XVC054, XVC1004P, XVC1005P, XVC1015G, XVC104, XVC105, XVC1204P, XVC2015G, XVC204, XVC304, XVC504, XVC704, XVC905P, XVT203G		

#### plugs/bushes

			
1			
<b>GEV No.</b>	378375	<b>Ref. No.</b>	TR121 TR21
<b>description</b>	female connector 2-pole for core temperature probe		
<b>For models:</b>	XV202E, XV301E, XV401E, XV501E		

			
1			
<b>GEV No.</b>	378376	<b>Ref. No.</b>	TR122 TR22
<b>description</b>	lid for plug contact		
<b>For models:</b>	XV202E, XV301E, XV401E, XV501E		

### electronics

#### PCBs

			
1			
<b>GEV No.</b>	403434	<b>Ref. No.</b>	KPE1730B PE1730B0
<b>description</b>	control PCB combi-steamer XVC1015G L 107mm W 60mm suitable for UNOX H 40mm		
<b>For models:</b>	XBC815G, XVC1015G, XVC2015G, XVC315G, XVC515G, XVC715G		

			
1			
<b>GEV No.</b>	403758	<b>Ref. No.</b>	KPE1105A
<b>description</b>	control PCB convection oven suitable for UNOX with control panel		

			
1			
<b>GEV No.</b>	403760	<b>Ref. No.</b>	KPE1195C PE1195B0 PE1195C1
<b>description</b>	control PCB L 290mm W 27mm suitable for UNOX		
<b>For models:</b>	XF115, XF135, XF185, XF188, XF195		

			
<b>GEV No.</b>	403757	<b>Ref. No.</b>	KPE1740A KPE1740C PE1740A0
<b>description</b>	display PCB convection oven XBC/XVC suitable for UNOX		
<b>For models:</b>	XBC1005, XBC1005E, XBC1005EL, XBC1015EG, XBC1015EGL, XBC405E, XBC605, XBC605E, XBC615EG, XBC805, XBC805E, XBC815EG, XBC815G, XBC905E, XBC905EL, XBC915EG, XBC915EGL, XVC055E, XVC1005EP, XVC1005EPL, XVC1005P, XVC1015EG, XVC1015EGL, XVC1015G, XVC105, XVC105E, XVC105EP, XVC1205EP, XVC1215EG, XVC2005EP, XVC2015EG, XVC2015G, XVC205, XVC205E, XVC305, XVC305E, XVC305EP, XVC315EG, XVC315G, XVC4005EP, XVC4005EPL, XVC4015EG, XVC4015EGL, XVC505, XVC505E, XVC505EP, XVC515EG, XVC705, XVC705E, XVC705EP...(Other models you can see in the webshop)		

			
<b>GEV No.</b>	401699	<b>Ref. No.</b>	KPE006 KPE009 KPE1355D PE1355D0
<b>description</b>	keypad PCB suitable for UNOX		
<b>For models:</b>	XVC054, XVC104, XVC204, XVC304, XVC504, XVC704		

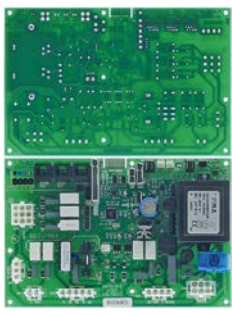
			
<b>GEV No.</b>	401700	<b>Ref. No.</b>	KPE005 KPE1365C PE1365C0 PE1365C0+KPE005 PE1365C2
<b>description</b>	main PCB for combi-steamer L 220mm W 145mm suitable for UNOX with mounting accessories		
<b>For models:</b>	XVC054, XVC104, XVC1204P, XVC204, XVC304, XVC504, XVC514G, XVC704		

			
<b>GEV No.</b>	402077	<b>Ref. No.</b>	PE1510B0
<b>description</b>	PCB		

			
<b>GEV No.</b>	403848	<b>Ref. No.</b>	KPE1010A PE1010A2
<b>description</b>	PCB for combi-steamer Cheflux-Bakerlux L 250mm W 86mm suitable for UNOX with mounting accessories		
<b>For models:</b>	XB403, XB403G, XB603, XB603G, XB803, XB803G, XG413, XG613, XG813G, XV203G, XV303G, XV703G		

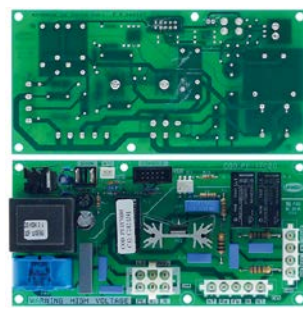
			
<b>GEV No.</b>	403850	<b>Ref. No.</b>	KPE1170B PE1170B0
<b>description</b>	PCB for combi-steamer LINE MISS CLASSIC L 155mm W 77mm suitable for UNOX with mounting accessories		
<b>For models:</b>	XF100, XF110, XF130, XF190		

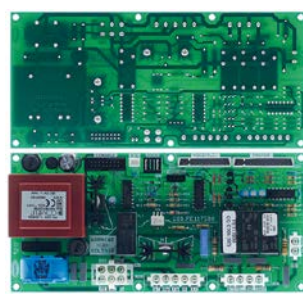
			
<b>GEV No.</b>	403849	<b>Ref. No.</b>	KPE004 KPE1175B PE1175B0
<b>description</b>	PCB for combi-steamer LINE MISS DYNAMIC L 200mm W 95mm suitable for UNOX with mounting accessories		
<b>For models:</b>	XF115, XF119, XF135, XF185, XF188, XF195		

			
<b>GEV No.</b>	403847	<b>Ref. No.</b>	KPE1010B PE1010B1
<b>description</b>	PCB for combi-steamer XB-XV-XG L 304mm W 95mm suitable for UNOX with mounting accessories		
<b>For models:</b>	XB403, XB403G, XB603, XB603G, XB803, XB803G, XBT146, XBT160, XG413G, XG613, XG613G, XG813, XV1003G, XV203G, XV303G, XV703G		



## central units



1

<b>GEV No.</b>	402171	<b>Ref. No.</b>	MG307
<b>description</b>	control box for coffee machine 230V type MFC2SG		

## keypads

## front foils



1

<b>GEV No.</b>	403756	<b>Ref. No.</b>	KPE1210A PE1210A0
<b>description</b>	keypad foil grey suitable for UNOX L 485mm W 97mm		

1

<b>GEV No.</b>	403879	<b>Ref. No.</b>	KPE1255A PE1255A0 PE1255A1
<b>description</b>	keypad foil suitable for UNOX for LINE MISS DYNAMIC L 655mm W 35mm		
<b>For models:</b>	XF185, XF188, XF195		

1

<b>GEV No.</b>	403759	<b>Ref. No.</b>	KPE1330A PE1330A0 PE1330A1
<b>description</b>	keypad foil suitable for UNOX for model XF180/190 L 655mm W 35mm		
<b>For models:</b>	XF190		



1

<b>GEV No.</b>	403755	<b>Ref. No.</b>	KMS1005A
<b>description</b>	keypad foil suitable for UNOX L 655mm W 35mm		



1

<b>GEV No.</b>	403880	<b>Ref. No.</b>	PE1215A PE1215A0
<b>description</b>	keypad foil yellow suitable for UNOX for XB-series until April 2004 L 485mm W 97mm		

## control panel



1

<b>GEV No.</b>	508425	<b>Ref. No.</b>	KPE1315A PE1315A0
<b>description</b>	control panel convection oven L 800mm mounting pos. lower grey plastic suitable for LINE MISS UNOX		
<b>For models:</b>	XF185, XF188, XF190, XF195		

## solenoid valves

## solenoid valves (water)

RPE

JOHN GUEST





1

<b>GEV No.</b>	374091	<b>Ref. No.</b>	EL1310A KEL1310A
<b>description</b>	solenoid valve 230VAC inlet 1/2" (tube ø 8mm) outlet 1/2" (tube ø 8mm) plastic		







solenoid valves with reducers			
single			
			
<b>GEV No.</b>	374058	<b>Ref. No.</b>	EL1411A EL1411A0 KEL1411A
<b>description</b>	solenoid valve 230VAC inlet JG 8 outlet JG 8 t.max. 60°C RPE flow regulating valve outlet white output A 1-1.25l/min		

			
<b>GEV No.</b>	374029	<b>Ref. No.</b>	EL1155A0 KEL1155A KEL1155A0
<b>description</b>	solenoid valve single straight 220-240VAC inlet 3/4" outlet JG 8 input 10-12l/min output 0.2-0.33l/min t.max. 60°C duty cycle 100% RPE plastic flow regulating valve outlet red flow regulating valve inlet white 1-ways medium temp max. 25°C		

			
<b>GEV No.</b>	374009	<b>Ref. No.</b>	EL029 EL1011 EL1041A0 EL1085A0 KEL1085A
<b>description</b>	solenoid valve single straight 220-240VAC inlet 3/4" outlet JG 8 input 10-12l/min t.max. 60°C duty cycle 100% RPE plastic flow regulating valve inlet white 1-ways medium temp max. 25°C		
<b>For models:</b>	XBT146, XF090P, XF185, XF188, XF195, XG413, XG413G, XG613, XL041, XV202, XV202E, XV203G, XV301, XV301E, XV303G, XVT203G		

			
<b>GEV No.</b>	374040	<b>Ref. No.</b>	EL125A0 KEL1252A
<b>description</b>	solenoid valve single straight 230VAC inlet JG 8 outlet JG 10 output 0.45l/min t.max. 60°C duty cycle 100% flow regulating valve outlet green 2-ways with quick release connection		

			
<b>GEV No.</b>	370481	<b>Ref. No.</b>	EL1250A0 EL1251A0 KEL1250A KEL1251A
<b>description</b>	solenoid valve single straight 230VAC inlet JG 8 outlet JG 10 t.max. 60°C duty cycle 100% flow regulating valve outlet light brown output A 0.12l/min		
<b>For models:</b>	XBC404, XBC604, XBC804, XVC054, XVC1004P, XVC104, XVC204, XVC304, XVC504, XVC514G, XVC704		

2-fold			
			
<b>GEV No.</b>	374037	<b>Ref. No.</b>	EL025 EL1160A0 KEL1160A
<b>description</b>	solenoid valve double straight 220-240VAC inlet 3/4" outlet JG 8 input 10-12l/min t.max. 60°C duty cycle 100% RPE plastic flow regulating valve inlet white output A 0.2-0.33l/min output B 0.2-0.33l/min flow regulating valve outlet A red flow regulating valve outlet B red output A John Guest 8mm output B John Guest 8mm		
<b>For models:</b>	XB403, XB403G, XB603, XB603G, XBT160, XG613G, XL503, XV201, XV401, XV401E, XV703G		

			
<b>GEV No.</b>	374038	<b>Ref. No.</b>	EL1360A0 EL1360A1 KEL1360A KEL1361A
<b>description</b>	solenoid valve special 220-240VAC inlet JG 8 outlet JG 10 t.max. 60°C RPE UNOX plastic		
<b>For models:</b>	XBC1005, XBC605, XBC805, XBC815G, XVC1005P, XVC105, XVC2015G, XVC205, XVC305, XVC505, XVC515G, XVC705, XVC715G, XVC905P		

3-fold			
			
<b>GEV No.</b>	371299 <sup>1</sup>	<b>Ref. No.</b>	EL026 EL1050A0 KEL1050A
<b>description</b>	solenoid valve triple straight 220-240VAC inlet 3/4" outlet 10mm t.max. 90°C duty cycle 100% RPE output A 0.07-0.14l/min output B 0.07-0.14l/min output C 0.07-0.14l/min		
<b>For models:</b>	XB803, XB803G, XG813, XG813G, XV501, XV501E		

<sup>1</sup>cylindrical outlet

			
<b>GEV No.</b>	374036 <sup>1</sup>	<b>Ref. No.</b>	EL1150A0 EL1165A0 KEL1165A
<b>description</b>	solenoid valve triple straight 220-240VAC inlet 3/4" outlet 8mm input 10-12l/min t.max. 60°C duty cycle 100% RPE plastic flow regulating valve inlet white output A 0.2-0.33l/min output B 0.2-0.33l/min output C 0.2-0.33l/min flow regulating valve outlet A red flow regulating valve outlet B red flow regulating valve outlet C red		
<b>For models:</b>	XB803, XB803G, XG813, XV1003G		

<sup>1</sup>cylindrical outlet



various



<b>GEV No.</b>	374101	<b>Ref. No.</b>	KVE1135A
<b>description</b>	solenoid valve UNOX 230VAC inlet 28mm outlet 16mm RPE plastic		

## Solenoid valve - accessories



<b>GEV No.</b>	530903	<b>Ref. No.</b>	VE115A
<b>description</b>	solenoid coil plug type F6.3x0.8 230V for combi-steamer		

## fans

## axial fans



<b>GEV No.</b>	601937	<b>Ref. No.</b>	KVN1120B VN1120B1
<b>description</b>	axial fan L 119mm W 119mm H 32mm 12VDC connection plug cable length 2000mm plastic fan wheel ø 110mm		
<b>For models:</b>	XB695, XB895, XV593		

## hot air motors



<b>GEV No.</b>	601965	<b>Ref. No.</b>	KVN1036A VN1036A0
<b>description</b>	fan motor 230V 1 phase 50/60Hz L1 110mm L2 50mm L3 12mm D1 ø 8mm D2 ø 6mm mounting thread M6		

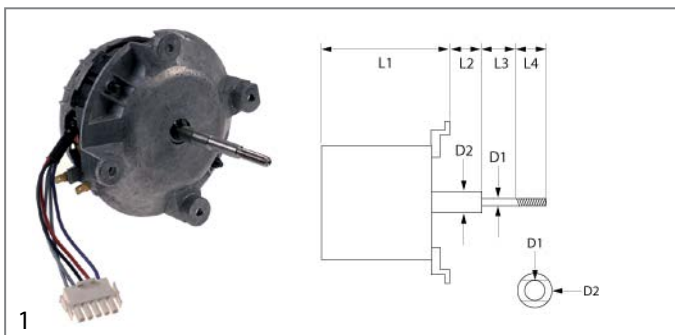

<b>GEV No.</b>	601493	<b>Ref. No.</b>	KVN003 KVN1000B VN1000A0 VN1000B0 VN1000B1
<b>description</b>	fan motor 230V 3 phase 50HzkW speeds 1 L1 85mm L2 32mm L3 28mm L4 29mm D1 ø 8mm D2 ø 12mm		
<b>For models:</b>	XB403, XB403G, XB603, XB603G, XB803, XB803G, XBC404, XBC604, XBC804, XBT146, XBT160, XF043, XF183, XF185, XF188, XF190, XF193, XF195, XG413, XG413G, XG613, XG613G, XG813, XG813G, XV1003G, XV203G, XV303G, XV703G, XVC054, XVC1004P, XVC104, XVC1204P, XVC204, XVC304, XVC504, XVC514G, XVC704, XVT203G		

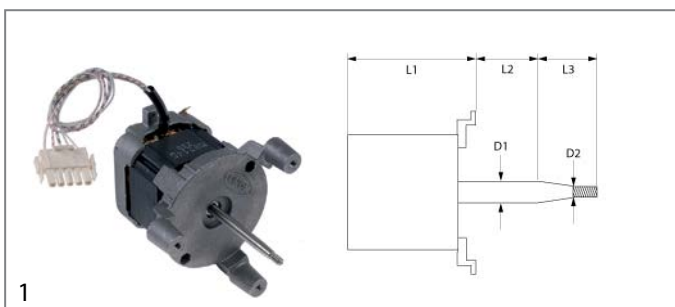

<b>GEV No.</b>	601492	<b>Ref. No.</b>	KVN017 KVN1035B VN1035B0
<b>description</b>	fan motor L1 130mm L2 18mm L3 23mm D1 ø 8mm D2 ø 7mm mounting thread M6R ET		
<b>For models:</b>	XF003, XF023, XF113, XF133		



<b>GEV No.</b>	601487	<b>Ref. No.</b>	KVN008 KVN1025A VN1005 VN1005A0 VN1025A0 VN1025A2
<b>description</b>	fan wheel D1 ø 196mm H1 61mm blades 39 D2 ø 10/8mm D3 ø 10mm H2 32mm		
<b>For models:</b>	XB403, XB403G, XB603, XB603G, XB803, XB803G, XBT146, XBT160, XF043, XF183, XF185, XF188, XF190, XF193, XF195, XG413, XG413G, XG613, XG613G, XG813, XG813G, XV203G, XV303G, XV703G, XVC054, XVC104, XVC204, XVC304, XVC504, XVC704, XVT203G		



1

<b>GEV No.</b>	602124	<b>Ref. No.</b>	VN043
<b>description</b>	fan wheel D1 ø 196mm H1 61mm blades 39 D2 ø 8mm D3 ø 8x6.5mm H2 27mm		
<b>For models:</b>	XV501, XV501E		



1

<b>GEV No.</b>	601776	<b>Ref. No.</b>	KVN007 KVN1020A VN041 VN1020A0
<b>description</b>	fan wheel D1 ø 197mm H1 43mm blades 39 D2 ø 8mm D3 ø 8x6.5mm H2 28mm		
<b>For models:</b>	XV202, XV202E, XV301, XV301E, XV401, XV401E, XV501		



1

<b>GEV No.</b>	601945	<b>Ref. No.</b>	KVN009 KVN1030A VN1030A0 VN1030A2 VN1030A3 VN1030A4
<b>description</b>	fan wheel D1 ø 196mm H1 81mm blades 39 D2 ø 10mm D3 ø 10mm H2 18mm		
<b>For models:</b>	XB693, XB695, XB893, XB895, XBC1005, XBC404, XBC604, XBC605, XBC804, XBC805, XBC815G, XG413G, XG813, XV1003G, XV593, XVC1004P, XVC1005P, XVC1015G, XVC105, XVC1204P, XVC2015G, XVC205, XVC305, XVC315G, XVC505, XVC514G, XVC515G, XVC705, XVC715G, XVC905P		



1

<b>GEV No.</b>	551100	<b>Ref. No.</b>	GN1140 GN1140A0 GN1140A1 KGN1140A
<b>description</b>	gasket for fan motor ID ø 10mm ED ø 40mm thickness 0.8mm		
<b>For models:</b>	XB403, XB403G, XB603, XB603G, XB693, XB695, XB803, XB803G, XB893, XB895, XBC1005, XBC404, XBC604, XBC605, XBC804, XBC805, XBC815G, XBT146, XBT160, XG413G, XG613G, XG813, XV1003G, XV203G, XV303G, XV593, XV703G, XVC054, XVC1004P, XVC1005P, XVC104, XVC105, XVC1204P, XVC2015G, XVC204, XVC205, XVC304, XVC305, XVC504, XVC505, XVC514G, XVC515G, XVC704, XVC705, XVC715G, XVC905P		



1

<b>GEV No.</b>	601489	<b>Ref. No.</b>	KVN011 KVN1050A VN1050A0
<b>description</b>	fan wheel D1 ø 197mm H1 32mm blades 39 D2 ø 8mm D3 ø 8mm H2 12mm		
<b>For models:</b>	XF100, XF103, XF110, XF113, XF115, XF130, XF133, XF135		





hot air fans

miscellaneous

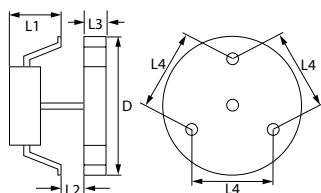

1



<b>GEV No.</b>	601125	<b>Ref. No.</b>	VN050
<b>description</b>	hot air fan 220-240V 45W 50/60Hz L1 70mm L2 11mm L3 25mm L4 87mm fan wheel ø 150mm FIME type C30R0479CLF		
<b>For models:</b>	XF006, XF010, XF011, XF020, XF020R, XF030, XF030-TG, XF040, XF050, XF065		
<b>accessories for</b>	601125		
	<b>GEV No.</b>	550879	<b>Ref. No.</b> —
	insulation ø 130mm thickness 3mm hole ø 18mm for hot air fan		

accessories

miscellaneous



1

<b>GEV No.</b>	551279	<b>Ref. No.</b>	OH4305A1 KOH4305A KOH4305A OH4305A1
<b>description</b>	cover ø 71mm thickness 1.2mm hole ø 18mm shaft sealing		
<b>For models:</b>	XB693, XB695, XB893, XB895, XBC1005, XBC605, XBC805, XV593, XVC1005P, XVC1015G, XVC105, XVC205, XVC305, XVC315G, XVC505, XVC515G, XVC705, XVC715G, XVC905P		



1

<b>GEV No.</b>	551280	<b>Ref. No.</b>	OH3020 OH3020A0 OH3020A1
<b>description</b>	cover ø 75mm thickness 1mm hole ø 18mm shaft sealing		
<b>For models:</b>	XBC404, XBC604, XBC804, XF113, XF133, XVC054, XVC1004P, XVC104, XVC1204P, XVC204, XVC304, XVC504, XVC514G, XVC704		

radial fans

miscellaneous



1

<b>GEV No.</b>	601939	<b>Ref. No.</b>	KVN1055A VN1055A0
<b>description</b>	radial fan 230V voltage AC 50/60Hz 190W D1 ø 133mm with heating element		
<b>For models:</b>	XC595		

motors

motors

for combi-steamers



1

<b>GEV No.</b>	601948	<b>Ref. No.</b>	KVN002 KVN0027A VN026 VN027
<b>description</b>	motor 120W 230V 50-60Hz 1 phase shaft ø 8mm shaft length 67mm flange ø 165mm ø 165mm H 150mm mounting distance 140mm S1SME 0.12kW		
<b>For models:</b>	XV202, XV202E, XV301, XV301E, XV401, XV401E, XV501, XV501E		





			
1			
<b>GEV No.</b>	403419	<b>Ref. No.</b>	KVN1130A VN1130A0
<b>description</b>	motor UNOX XBC/XVC SISME		
<b>For models:</b>	XB693, XB695, XB893, XB895, XBC1005, XBC605, XBC805, XV593, XVC1005P, XVC1015G, XVC105, XVC2015G, XVC205, XVC305, XVC315G, XVC505, XVC515G, XVC705, XVC715G, XVC905P		

**pumps**

**booster pumps II**

<b>accessories</b>			
			
1			
<b>GEV No.</b>	365017	<b>Ref. No.</b>	KCN1000A VE1145A0
<b>description</b>	operating capacitor capacity 5µF 450V tolerance 5% 50/60Hz ambient temperature max. -25 to +85°C ø 28mm L 54mm M8 plastic connection male faston 6.3mm 16.10.08 protection		
<b>For models:</b>	XF003, XF023, XF100, XF103, XF110, XF113, XF115, XF119, XF130, XF133, XF135		

**vibration pumps**

			
1			
<b>GEV No.</b>	499360	<b>Ref. No.</b>	XC665
<b>description</b>	vibration pump kit type NME Typ1C 230-240V 16W 50Hz inlet ø 5 outlet ø 8 ULKA L 90mm		
			
1			
<b>GEV No.</b>	499350	<b>Ref. No.</b>	KVL0009A KVL1038A
<b>description</b>	vibration pump type MPP1.01.066.2/ST/S 230V 28W 50Hz inlet ø 6 outlet ø 8 kit L 111mm		

**condensators & interference suppression filters**

**operating capacitors**

<b>plastic</b>			
			
1			
<b>GEV No.</b>	365017	<b>Ref. No.</b>	KCN1000A VE1145A0
<b>description</b>	operating capacitor capacity 5µF 450V tolerance 5% 50/60Hz ambient temperature max. -25 to +85°C ø 28mm L 54mm M8 plastic connection male faston 6.3mm 16.10.08 protection		
<b>For models:</b>	XF003, XF023, XF100, XF103, XF110, XF113, XF115, XF119, XF130, XF133, XF135		

<b>metal</b>			
			
1			
<b>GEV No.</b>	365219	<b>Ref. No.</b>	CN1003A KCN1003A
<b>description</b>	operating capacitor capacity 6.3µF 400V tolerance 5% 50-60Hz ambient temperature max. -25 up to +70°C ø 35mm L 59.5mm M8 aluminium connection male faston 6.3mm		
<b>For models:</b>	XBC1005E, XBC1005EL, XBC1015EG, XBC1015EGL, XBC405E, XBC605E, XBC615EG, XBC805E, XBC905E, XBC905EL, XBC915EG, XBC915EGL, XV393, XVC055E, XVC1005EP, XVC1005EPL, XVC1015EG, XVC1015EGL, XVC105E, XVC105EP, XVC1205EP, XVC2005EP, XVC205E, XVC305E, XVC305EP, XVC315EG, XVC4005EP, XVC4005EPL, XVC4015EG, XVC4015EGL, XVC505E, XVC505EP, XVC515EG, XVC705E, XVC705EP, XVC715EG, XVC905EP, XVC905EPL, XVC915EG, XVC915EGL		

**fuses**

**fine fuses**

			
1			
<b>GEV No.</b>	358373	<b>Ref. No.</b>	VG1001A0
<b>description</b>	fine fuse size ø5x20mm 1.6A fast-acting rated 250V		
<b>For models:</b>	XVC1015G, XVC315G		



fine fuse holders



<b>GEV No.</b>	358177	<b>Ref. No.</b>	KVG1000A VE301
<b>description</b>	fuse holder suitable fuse ø5x20mm ø 16mm mounting ø 13mm 1-pole 6.3A rated 250V L 54mm connection male faston 6.3mm		
<b>For models:</b>	XG413G, XG613, XG613G, XG813, XG813G		

connection cables



<b>GEV No.</b>	403469	<b>Ref. No.</b>	IE1820A0 KIE1820A
<b>description</b>	connection cable L 1100mm 2-pole suitable for UNOX connection plug		
<b>For models:</b>	XVC1004P		

electric accessories

cables

power supply cables



<b>GEV No.</b>	551263	<b>Ref. No.</b>	CE116 KMR1000A MR1000A0
<b>description</b>	power lead CEE7/7 type E+F 3-pole contacts P+N+E max. 16A max 250V 1.5m H07 RN-F with power terminal block countries D/F/B/I black		
<b>For models:</b>	XC110, XC111, XC224, XC314, XC400, XC503, XC595, XCH030, XF003, XF006, XF010, XF011, XF016, XF020, XF020R, XF023, XF030, XF030-TG, XF040, XF050, XF065, XF100, XF103, XF110, XF113, XF115, XF119, XF130, XF133, XF135, XG413, XG413G, XG613, XG613G, XG813, XG813G, XK304, XL041, XL051, XL091, XL135, XL146, XL195, XL314, XL404, XL405, XL503, XL504, XL505, XP010P...(Other models you can see in the webshop)		

terminals

connection terminals with screw/faston connec-  
tions

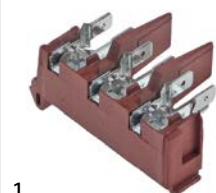

<b>GEV No.</b>	551278	<b>Ref. No.</b>	CE1575A0
<b>description</b>	power terminal block 3-pole max. 40A max 450V connection M6/ male faston 6.3mm temp.-resist. 150°C cross section 6mm <sup>2</sup>		
<b>For models:</b>	XVC1015G		



<b>GEV No.</b>	551267	<b>Ref. No.</b>	CE119 MR1006A0
<b>description</b>	power lead CEE7/7 type E+F 3-pole contacts P+N+E max. 16A max 250V 1.5m H07 RN-F with power terminal block countries D/F/B/I black		
<b>For models:</b>	XF183, XF185, XF188		

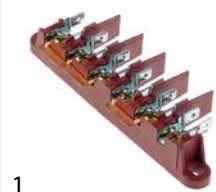

<b>GEV No.</b>	551266	<b>Ref. No.</b>	CE211
<b>description</b>	power terminal block 6-pole max. 40A max 450V connection M5/ male faston 6.3mm temp.-resist. 150°C		
<b>For models:</b>	XV301, XV301E, XV401, XV401E		

ribbon cables

group 1

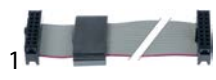

<b>GEV No.</b>	403857	<b>Ref. No.</b>	CE1100A0 CE1100A1 KCE1100A
<b>description</b>	ribbon cable 16-pole L 1005mm plug type FC-16P raster size 2.54mm		



<b>GEV No.</b>	403846	<b>Ref. No.</b>	CE1110A1 CE118
<b>description</b>	ribbon cable 20-pole L 1210mm plug type FC-20P raster size 2.54mm		
<b>For models:</b>	XV202E, XV401E		



<b>GEV No.</b>	551260	<b>Ref. No.</b>	CE212 KMR1004A MR1004A0
<b>description</b>	power terminal block 7-pole max. 40A max 450V connection M5/ male faston 6.3mm temp.-resist. 150°C		
<b>For models:</b>	XB403, XB403G, XB603, XB603G, XB693, XB695, XB803, XB803G, XB893, XB895, XBC404, XBC604, XBC605, XBC804, XBC805, XBT146, XBT160, XV1003G, XV203G, XV303G, XV501, XV501E, XV593, XV703G, XVC2015G, XVC204, XVC205, XVC304, XVC305, XVC504, XVC505, XVC704, XVC705, XVT203G		



connection terminals with screw connection



<b>GEV No.</b>	551274	<b>Ref. No.</b>	CE1420A0
<b>description</b>	distribution terminal block 8-pole temp.-resist. 85°C cross section 16/6mm <sup>2</sup>		
<b>For models:</b>	XBC1005, XVC1004P, XVC1005P, XVC905P		

various



<b>GEV No.</b>	550987	<b>Ref. No.</b>	CE1130A0
<b>description</b>	power terminal block 5-pole with cable cable length 1400mm		
<b>For models:</b>	XF190, XF193, XF195		



<b>GEV No.</b>	693955	<b>Ref. No.</b>	VM250
<b>description</b>	terminal grounding cable		
<b>For models:</b>	XB603, XBC404, XBC604, XBC605, XBC804, XBC805, XBC815G, XBT146, XBT160, XC111, XC114, XC314, XC400, XC503, XC595, XCH030, XF003, XF006, XF011, XF016, XF023, XF030, XF030-TG, XF043, XF065, XF090P, XF100, XF103, XF110, XF113, XF115, XF119, XF130, XF133, XF135, XF183, XF185, XF188, XF190, XF193, XF195, XG413, XG413G, XG613, XG613G, XG813, XG813G, XK304, XL041, XL051...(Other models you can see in the webshop)		

gas valves and ignition boxes

gas control valves

HONEYWELL





<b>GEV No.</b>	107579	<b>Ref. No.</b>	EL1080A0
<b>description</b>	gas valve type VK4105A 1100 4 220/240V 50/60Hz gas inlet 3/4" gas outlet 3/4" pressure range 15-60mbar max 60mbar HONEYWELL		
<b>For models:</b>	XG413G, XG613, XG613G, XG813, XG813G		

SIT

SIGMA



<b>GEV No.</b>	101989	<b>Ref. No.</b>	EL014	
<b>description</b>	gas valve 230V 50Hz gas inlet 3/4" gas outlet 3/4" SIT pressure range 2-50mbar equiv. no. 0.840.016			
<b>spare parts for</b>	101989			
	<b>GEV No.</b>	106214	<b>Ref. No.</b>	—
	solenoid coil 230V 50Hz Sigma			
<b>accessories for</b>	101989			
	<b>GEV No.</b>	107222	<b>Ref. No.</b>	—
	plug for solenoid valve 3-pole cable length 1070mm			

TANDEM









<b>GEV No.</b>	101684	<b>Ref. No.</b>	EL015	
<b>description</b>	gas valve 230V 50Hz gas inlet 1/2" gas outlet 1/2" pilot connection level slow ignition standard ignition time 3-7s pressure range 3-50mbar power supply for modulator type SIT equiv. no. 0.830.034			
<b>spare parts for</b>	101684			
	<b>GEV No.</b>	101379	<b>Ref. No.</b>	—
	solenoid coil 230V 50Hz suitable for Tandem			
<b>accessories for</b>	101684			
	<b>GEV No.</b>	101274	<b>Ref. No.</b>	—
	olive for pipe ø 16mm Qty 1 pcs			
	<b>GEV No.</b>	101275	<b>Ref. No.</b>	—
	union screw thread 1/2" for pipe ø 16mm Qty 1 pcs			
	<b>GEV No.</b>	102845	<b>Ref. No.</b>	—
	gas connection angled 1/2" flange 32x32mm hole distance 24x24mm Tandem			
	<b>GEV No.</b>	102846	<b>Ref. No.</b>	—
	gas connection straight 1/2" flange 32x32mm hole distance 24x24mm suitable for Tandem			

Table continues overleaf



accessories for	101684		
	GEV No.	102847	Ref. No. —
	O-ring		

## ignition boxes

### HONEYWELL

Honeywell



1			
<b>GEV No.</b>	103197	<b>Ref. No.</b>	KVE1055A VE1055A0 VE1055A1
<b>description</b>	ignition box HONEYWELL type S4565C 3116B electrodes 2 waiting times safety time 5s 220-240V 4VA 50/60Hz		
<b>For models:</b>	XB613G, XB813G, XBC1015EG, XBC1015EGL, XBC615EG, XBC815EG, XBC815G, XBC915EG, XBC915EGL, XG413G, XG613, XG613G, XG813, XG813G, XV513G, XV813G, XVC1015EG, XVC1015EGL, XVC1015G, XVC1215EG, XVC2015EG, XVC2015G, XVC315EG, XVC4015EG, XVC4015EGL, XVC515EG, XVC515G, XVC715EG, XVC715G, XVC915EG, XVC915EGL		

### SIT



1			
<b>GEV No.</b>	102306	<b>Ref. No.</b>	KVE001 VE045A
<b>description</b>	ignition box SIT type 503EFD electrodes 1 waiting time 1.5s safety time 5s 220/240V 10VA 50-60Hz protection IP40		

## ignition parts

### electrodes



1			
<b>GEV No.</b>	107578	<b>Ref. No.</b>	BR1010A0 BR1010A1 BR1010B1 KBR1010B
<b>description</b>	ignition electrode flange length 38mm flange width 17mm D1 ø 9.3mm L1 24mm L2 24mm BL1 70mm BL2 25mm connection 6		
<b>For models:</b>	XG413G, XG613, XG613G, XG813, XG813G		



1			
<b>GEV No.</b>	107824	<b>Ref. No.</b>	BR1310A0 KBR1310A
<b>description</b>	ignition electrode flange length 64mm flange width 23mm D1 ø 9.4mm L1 20mm L2 15mm BL1 22mm BL2 26mm connection ø 6mm		
<b>For models:</b>	XBC815G, XVC1015G, XVC2015G, XVC515G, XVC715G		



1			
<b>GEV No.</b>	106924	<b>Ref. No.</b>	BR1015A0 KBR1015A
<b>description</b>	monitoring electrode flange length 38mm D1 ø 9.5mm flange width 17mm L1 25mm L2 21mm BL1 70mm BL2 24mm connection 6 mounting distance 28mm with flange		
<b>For models:</b>	XG413G, XG613, XG613G, XG813, XG813G		





ignition units



1

<b>GEV No.</b>	102485	<b>Ref. No.</b>	VE1065A0
<b>description</b>	ignition unit outputs 2 220-240VAC 0.6VA 50-60Hz		
<b>For models:</b>	XG413G, XG613, XG613G, XG813, XG813G, XVC1015G, XVC2015G, XVC515G, XVC715G		



1

<b>GEV No.</b>	101002	<b>Ref. No.</b>	KVE1065A
<b>description</b>	ignition unit outputs 2 230VAC dimensions 88x23x34mm mounting distance 73mm inlet F6.3x0.8 outlet F2.8x0.8 0.6VA 50/60Hz		



1

<b>GEV No.</b>	103348	<b>Ref. No.</b>	KVE0009B
<b>description</b>	ignition unit outputs 2 dimensions 85x62x38mm mounting distance 58/77mm set 4-piece 50/60Hz primary 230/240V secondary 28kV		

gas burners

burners for convection ovens



1

<b>GEV No.</b>	107585	<b>Ref. No.</b>	BR1000C0 BR1000D0 KBR1000D	
<b>description</b>	burner for oven L 610mm			
<b>For models:</b>	XG413G, XG613, XG613G, XG813			
<b>spare parts for</b>	107585			
	<b>GEV No.</b>	106924	<b>Ref. No.</b>	BR1015A0 KBR1015A
	monitoring electrode flange length 38mm D1 ø 9.5mm flange width 17mm L1 25mm L2 21mm BL1 70mm BL2 24mm connection 6 mounting distance 28mm with flange			



1

<b>GEV No.</b>	107583	<b>Ref. No.</b>	BR1305A0 KBR1305A
<b>description</b>	burner oven L 510mm W 200mm UNOX		
<b>For models:</b>	XBC815G, XVC2015G, XVC515G, XVC715G		

equipmentspecific units

for convection ovens/combi-steamers

bushes



1

<b>GEV No.</b>	692827	<b>Ref. No.</b>	KVI0540A KVM2003A RC540 VI0540A0
<b>description</b>	bushing mounting pos. door hinge ø 20mm ID ø 10mm for hot air oven plastic		
<b>For models:</b>	XFT119, XFT140, XFT199, XFT200		

flow controllers



1

<b>GEV No.</b>	103347	<b>Ref. No.</b>	EL033
<b>description</b>	flow controller for hot air oven RFL-U connection 1/8" thread M12x1 hose ø 10mm		
<b>For models:</b>	XV301, XV301E, XV401, XV401E, XV501, XV501E		

spare parts and accessories



1

<b>GEV No.</b>	694497	<b>Ref. No.</b>	KVM1235A VM1235A0
<b>description</b>	clip for door		
<b>For models:</b>	XBC404, XBC604, XBC605, XBC804, XBC805, XBC815G, XVC1204P, XVC2015G, XVC204, XVC205, XVC304, XVC305, XVC315G, XVC504, XVC505, XVC514G, XVC515G, XVC704, XVC705, XVC715G, XVC905P		



1

<b>GEV No.</b>	694983	<b>Ref. No.</b>	CR1086A KCR1086A
<b>description</b>	hinge inner door with mounting kit mounting pos. lower		
<b>For models:</b>	XB613G, XB693, XB695, XB813G, XB893, XB895, XBC405E, XBC605E, XBC615EG, XBC805E, XBC815EG, XBC905E, XBC905EL, XBC915EG, XBC915EGL, XV393, XV513G, XV593, XV813G, XV893, XVC1205EP, XVC1215EG, XVC2005EP, XVC2015EG, XVC205E, XVC305E, XVC305EP, XVC315EG, XVC505E, XVC505EP, XVC515EG, XVC705E, XVC705EP, XVC715EG, XVC905EP, XVC905EPL, XVC915EG, XVC915EGL		



1

<b>GEV No.</b>	694982	<b>Ref. No.</b>	CR1085A CR1085A + GN1181A KCR1085A
<b>description</b>	hinge inner door with mounting kit mounting pos. upper		
<b>For models:</b>	XB613G, XB693, XB695, XB813G, XB893, XB895, XBC405E, XBC605E, XBC615EG, XBC805E, XBC815EG, XBC905E, XBC905EL, XBC915EG, XBC915EGL, XV393, XV513G, XV593, XV813G, XV893, XVC1205EP, XVC1215EG, XVC2005EP, XVC2015EG, XVC205E, XVC305E, XVC305EP, XVC315EG, XVC505E, XVC505EP, XVC515EG, XVC705E, XVC705EP, XVC715EG, XVC905EP, XVC905EPL, XVC915EG, XVC915EGL		



1

<b>GEV No.</b>	692804	<b>Ref. No.</b>	CR005 CR1080A CR1081A KCR005 KCR1080A
<b>description</b>	hinge kit for inner door mounting pos. upper/lower		
<b>For models:</b>	XL413		



1

<b>GEV No.</b>	694984	<b>Ref. No.</b>	GN1180A0 KGN1180A
<b>description</b>	protector hinge L 95mm W 65mm Qty 4 pcs		
<b>For models:</b>	XB693, XB695, XBC404, XBC604, XBC605, XBC804, XBC805, XBC815G, XV593, XVC1204P, XVC2015G, XVC204, XVC205, XVC304, XVC305, XVC315G, XVC504, XVC505, XVC514G, XVC515G, XVC704, XVC705, XVC715G, XVC905P		

## front panels



1

<b>GEV No.</b>	508425	<b>Ref. No.</b>	KPE1315A PE1315A0
<b>description</b>	control panel convection oven L 800mm mounting pos. lower grey plastic suitable for LINE MISS UNOX		
<b>For models:</b>	XF185, XF188, XF190, XF195		

## housing and bezels



1

<b>GEV No.</b>	691524	<b>Ref. No.</b>	KVM1116A VM1116A0
<b>description</b>	cover left		
<b>For models:</b>	XF103, XF113, XF133, XF183, XF193		



1

<b>GEV No.</b>	691522	<b>Ref. No.</b>	VM1046A0
<b>description</b>	cover mounting pos. left		
<b>For models:</b>	XF100, XF103, XF110, XF113, XF115, XF130, XF133, XF135, XF183, XF185, XF188, XF190, XF193, XF195		



1

<b>GEV No.</b>	691523	<b>Ref. No.</b>	VM1045A0
<b>description</b>	cover right		
<b>For models:</b>	XF100, XF103, XF110, XF113, XF115, XF130, XF133, XF135, XF183, XF185, XF188, XF190, XF193, XF195		



1

<b>GEV No.</b>	691525	<b>Ref. No.</b>	VM1115A0
<b>description</b>	cover right		
<b>For models:</b>	XF103, XF113, XF133, XF183, XF193		

## cleaning system

### cleaning system assembly



1

<b>GEV No.</b>	520999	<b>Ref. No.</b>	KVL0005A
<b>description</b>	cleaning system assembly group suitable for UNOX combi-steamer		



1

<b>GEV No.</b>	521181	<b>Ref. No.</b>	KVL1044B
<b>description</b>	cleaning system suitable for UNOX combi-steamer		
<b>For models:</b>	XVC055E, XVC105E, XVC105EP, XVC205E, XVC305E, XVC305EP, XVC505E, XVC505EP, XVC705E, XVC705EP		



cleaning arms

 <p>1</p>			
<b>GEV No.</b>	542410	<b>Ref. No.</b>	KVL1037A VM1955A VM1955A0
<b>description</b>	cleaning arm suitable for UNOX combi-steamer		
<b>For models:</b>	XBC1005E, XBC1005EL, XBC405E, XBC605E, XBC615EG, XBC805E, XBC815EG, XBC905E, XBC905EL, XVC1005EP, XVC1005EPL, XVC1205EP, XVC1215EG, XVC2005EP, XVC2015EG, XVC305E, XVC305EP, XVC315EG, XVC4005EP, XVC4005EPL, XVC4015EG, XVC4015EGL, XVC505E, XVC505EP, XVC515EG, XVC705E, XVC705EP, XVC715EG, XVC905EP, XVC905EPL		

pipes

 <p>1</p>			
<b>GEV No.</b>	699467	<b>Ref. No.</b>	KVM1015A KVM1015A0 VM1015A1
<b>description</b>	pipe stainless steel ED ø 30mm 90°		

drip water trays

 <p>1</p>			
<b>GEV No.</b>	699456	<b>Ref. No.</b>	KVM1216B VM1216B0
<b>description</b>	drip tray L 747mm W 132mm H 24mm for combi-steamer UNOX		

 <p>1</p>			
<b>GEV No.</b>	699457	<b>Ref. No.</b>	KVM1220A KVM1220A0
<b>description</b>	mounting set for drip pan combi-steamer UNOX 4-fold		
<b>For models:</b>	XBC404, XBC405E, XBC604, XBC605, XBC605E, XBC615EG, XBC804, XBC805, XBC805E, XBC815EG, XBC815G, XBC905E, XBC905EL, XVC054, XVC055E, XVC104, XVC105, XVC105E, XVC105EP, XVC1204P, XVC1205EP, XVC1215EG, XVC2005EP, XVC2015EG, XVC2015G, XVC204, XVC205, XVC205E, XVC304, XVC305, XVC305E, XVC305EP, XVC315EG, XVC315G, XVC504, XVC505, XVC505E, XVC505EP, XVC514G, XVC515EG, XVC515G, XVC704, XVC705, XVC705E, XVC705EP, XVC715EG, XVC715G, XVC905EP, XVC905EPL		

door mechanics

miscellaneous

 <p>1</p>			
<b>GEV No.</b>	692827	<b>Ref. No.</b>	KVI0540A KVM2003A RC540 VI0540A0
<b>description</b>	bushing mounting pos. door hinge ø 20mm ID ø 10mm for hot air oven plastic		
<b>For models:</b>	XFT119, XFT140, XFT199, XFT200		

 <p>1</p>			
<b>GEV No.</b>	694987	<b>Ref. No.</b>	KVM1490A
<b>description</b>	cover for screws door handle for combi-steamer 2 pieces with screws		
<b>For models:</b>	XB613G, XB693, XB695, XB813G, XB893, XB895, XBC1005E, XBC1005EL, XBC1015EG, XBC1015EGL, XBC405E, XBC605E, XBC615EG, XBC805E, XBC815EG, XBC905E, XBC905EL, XBC915EG, XBC915EGL, XV513G, XV593, XV813G, XV893, XVC1005EP, XVC1005EPL, XVC1015EG, XVC1015EGL, XVC1205EP, XVC1215EG, XVC2005EP, XVC2015EG, XVC205E, XVC305E, XVC305EP, XVC315EG, XVC4005EP, XVC4005EPL, XVC4015EG, XVC4015EGL, XVC505E, XVC505EP, XVC515EG, XVC705E, XVC705EP, XVC715EG, XVC905EP, XVC905EPL, XVC915EG, XVC915EGL		

vibration pumps

 <p>1</p>			
<b>GEV No.</b>	499350	<b>Ref. No.</b>	KVL0009A KVL1038A
<b>description</b>	vibration pump type MPP1.01.066.2/ST/S 230V 28W 50Hz inlet ø 6 outlet ø 8 kit L 111mm		

knobs

accessories

fascias

 <p>1</p>			
<b>GEV No.</b>	112721	<b>Ref. No.</b>	KMN1050A MN1050A0 MN140
<b>description</b>	dial plate 0-120min t.max.°C°C for timer ø 58mm		
<b>For models:</b>	XF006, XF011, XF016, XF030, XF030-TG, XF090P		

mechanical components, equipment accessories





1

<b>GEV No.</b>	112715	<b>Ref. No.</b>	KMN0046B MN046	
<b>description</b>	dial plate thermostat t.max. 300°C 80-300°C ø 58mm hole distance 29mm			
<b>For models:</b>	XF065			
<b>accessories for</b>	112715			
	<b>GEV No.</b>	112714	<b>Ref. No.</b>	MN045
	dial plate top heat t.max.°C°C ø 58mm hole distance 29mm			



1

<b>GEV No.</b>	112714	<b>Ref. No.</b>	MN045	
<b>description</b>	dial plate top heat t.max.°C°C ø 58mm hole distance 29mm			
<b>For models:</b>	XF065			
<b>accessories for</b>	112714			
	<b>GEV No.</b>	112715	<b>Ref. No.</b>	KMN0046B MN046
	dial plate thermostat t.max. 300°C 80-300°C ø 58mm hole distance 29mm			

### knob adaptors



1

<b>GEV No.</b>	696692	<b>Ref. No.</b>	KVI1520A
<b>description</b>	shaft shaft ø 12mm center grooved pin 6x55 shaft flat 4.5		

### rosettes



1

<b>GEV No.</b>	112541	<b>Ref. No.</b>	KMN1095A MN1095A0
<b>description</b>	rosette for knob up to ø 41mm		
<b>For models:</b>	XF103, XF113, XF133, XF183, XF193		

## handles and hand wheels

### handle bars

### handle bars



1

<b>GEV No.</b>	691516	<b>Ref. No.</b>	OH3195A0
<b>description</b>	handle rod tube ø 18mm thickness 1mm L 508mm		
<b>For models:</b>	XF023		



1

<b>GEV No.</b>	691515	<b>Ref. No.</b>	OH1925A0
<b>description</b>	handle rod tube ø 18mm thickness 1mm L 518mm		
<b>For models:</b>	XF110, XF113, XF115, XF130, XF133, XF135		



1

<b>GEV No.</b>	691514	<b>Ref. No.</b>	OH1930A0	
<b>description</b>	handle rod tube ø 18mm thickness 1mm L 718mm			
<b>For models:</b>	XF183, XF185, XF188, XF190, XF193, XF195			
<b>accessories for</b>	691514			
	<b>GEV No.</b>	691517	<b>Ref. No.</b>	MG1015A0
	console for handle rod tube ø 18mm			



consoles



<b>GEV No.</b>	692217	<b>Ref. No.</b>	KMG1015B MG1015B0
<b>description</b>	console for handle rod H 43mm kit mounting pos. left/right		
<b>For models:</b>	XF003, XF043, XF113, XF133, XL405, XVC105		

door handles

door handles



<b>GEV No.</b>	692710	<b>Ref. No.</b>	KMG1035A MG1035A1
<b>description</b>	door handle suitable for UNOX L 200mm W 24mm model XL SS		
<b>For models:</b>	XL404		

locks

espagnolette locks

universal



<b>GEV No.</b>	690040	<b>Ref. No.</b>	MG309
<b>description</b>	door catch with roller H 42mm L 40mm W 40mm zinc die cast mounting distance 26mm type 0751 series		

hinges

oven hinges

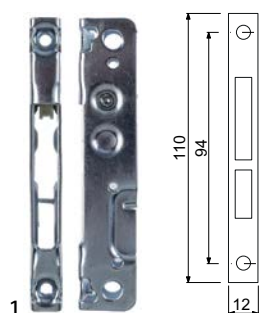

<b>GEV No.</b>	693045	<b>Ref. No.</b>	CR100
<b>description</b>	opposite support L 110mm W 12mm mounting distance 94mm		
<b>For models:</b>	XF006, XF011, XF016, XF030, XF030-TG, XF065, XF090P		



<b>GEV No.</b>	701559	<b>Ref. No.</b>	CR1000A CR1000A0 KCR1000A
<b>description</b>	opposite support mounting distance 81mm L 134mm W 10mm		
<b>For models:</b>	XF100, XF103, XF110, XF113, XF115, XF130, XF133, XF135, XF183, XF185, XF188, XF190, XF193, XF195, XFT110, XFT113, XFT115, XFT130, XFT133, XFT135, XFT180, XFT183, XFT185, XFT188, XFT190, XFT193, XFT195, XVC054, XVC104, XVC105		

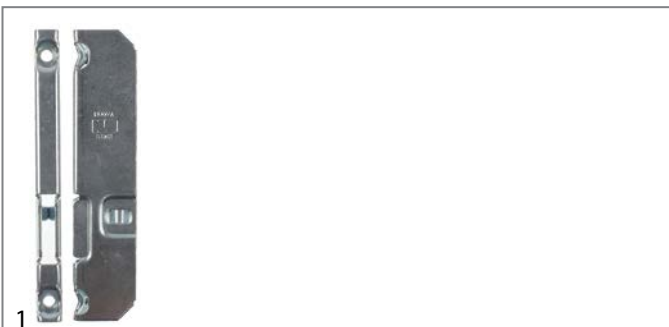

<b>GEV No.</b>	701552	<b>Ref. No.</b>	CR1070A KCR1070A
<b>description</b>	opposite support mounting distance 94mm L 112mm W 10mm		
<b>For models:</b>	XF023, XF043		



<b>GEV No.</b>	701169 <sup>1</sup>	<b>Ref. No.</b>	KCR0020A KCR003
<b>description</b>	oven hinge kit mounting distance 118mm lug mounting 13mm lever length 117mm groove distance 7mm spring thickness 2.7mm mounting ear position left/right spring length 58mm L 155mm W 20mm suitable for UNOX		

<sup>1</sup>with opposite support

mechanical components, equipment accessories

<b>GEV No.</b>	700459	<b>Ref. No.</b>	CR070
<b>description</b>	oven hinge mounting distance 142mm mounting distance 2mm lug mountingmm lever length 117mm groove distance 7mm spring thickness 3.5mm mounting ear position spring length 58mm L 156mm W 22mm		
<b>For models:</b>	XF030, XF030-TG, XF065		
<b>accessories for</b>	700459		
	<b>GEV No.</b>	693045	<b>Ref. No.</b> CR100
	opposite support L 110mm W 12mm mounting distance 94mm		

<b>GEV No.</b>	700759	<b>Ref. No.</b>	CR1015A CR1015A0 KCR013 KCR1015A
<b>description</b>	oven hinge mounting distance 82mm spring thickness 3mm spring length 57mm L 155mm code A3 left/right Qty 2 pcs		
<b>For models:</b>	XFT130, XFT133, XFT135		
<b>accessories for</b>	700759		
	<b>GEV No.</b>	701559	<b>Ref. No.</b> CR1000A CR1000A0 KCR1000A
	opposite support mounting distance 81mm L 134mm W 10mm		

<b>GEV No.</b>	701544	<b>Ref. No.</b>	KCR012 KCR1025A
<b>description</b>	oven hinge mounting distance 82mm spring thickness 3mm spring length 57mm L 155mm code A1 left/right Qty 2 pcs		

<b>GEV No.</b>	701326	<b>Ref. No.</b>	CR1075A CR1075A0 CR1075B0 KCR1075A KCR1075B
<b>description</b>	oven hinge mounting distance 87mm spring thickness 3.2mm L 150mm left/right C 10mm suitable for UNOX Qty 2 pcs		
<b>For models:</b>	XF043		
<b>accessories for</b>	701326		
	<b>GEV No.</b>	701552	<b>Ref. No.</b> CR1070A KCR1070A
	opposite support mounting distance 94mm L 112mm W 10mm		

<b>GEV No.</b>	701545	<b>Ref. No.</b>	KCR1020A0 KCR1020B
<b>description</b>	oven hinge mounting distance 82mm spring thickness 3mm spring length 57mm L 155mm code A2 left/right Qty 2 pcs		

<b>GEV No.</b>	700760	<b>Ref. No.</b>	CR1065A0 KCR020 KCR1065A
<b>description</b>	oven hinge mounting distance 87mm spring thickness 3mm L 150mm left/right Qty 2 pcs		
<b>For models:</b>	XF023		
<b>accessories for</b>	700760		
	<b>GEV No.</b>	701552	<b>Ref. No.</b> CR1070A KCR1070A
	opposite support mounting distance 94mm L 112mm W 10mm		





			
<b>GEV No.</b>	440012	<b>Ref. No.</b>	CR025 KCR0025A
<b>description</b>	oven hinge set		
<b>For models:</b>	XF006, XF010, XF011, XF020, XF020R		

			
<b>GEV No.</b>	694558	<b>Ref. No.</b>	2xCR065+2xCR100 KCR0065A KCR007
<b>description</b>	oven hinge set lever length 125mm L 156mm suitable for UNOX		

			
<b>GEV No.</b>	700994	<b>Ref. No.</b>	KCR0070A KCR008
<b>description</b>	oven hinge set lever length 125mm L 156mm suitable for UNOX ARIANNA, ELENA		

			
<b>GEV No.</b>	701314	<b>Ref. No.</b>	CR1010A0 KCR014 KCR1010A0
<b>description</b>	oven hinge set mounting distance 82mm spring thickness 2.8mm L 155mm left/right windings 16 Qty 2 pcs		
<b>For models:</b>	XF110, XF113, XF115		

			
<b>GEV No.</b>	701410	<b>Ref. No.</b>	CR1050A CR1050A0 KCR016 KCR1050A
<b>description</b>	oven hinge set mounting distance 82mm spring thickness 3.4mm L 155mm left/right windings 13 Qty 2 pcs		
<b>For models:</b>	XFT190, XFT193, XFT195, XVC055E, XVC105E, XVC105EP		
<b>accessories for</b>	701410		
		<b>GEV No.</b>	701559
		<b>Ref. No.</b>	CR1000A CR1000A0 KCR1000A
	opposite support mounting distance 81mm L 134mm W 10mm		

door bearing

			
<b>GEV No.</b>	692827	<b>Ref. No.</b>	KVI0540A KVM2003A RC540 VI0540A0
<b>description</b>	bushing mounting pos. door hinge ø 20mm ID ø 10mm for hot air oven plastic		
<b>For models:</b>	XFT119, XFT140, XFT199, XFT200		

			
<b>GEV No.</b>	701626	<b>Ref. No.</b>	KVM1165B VM1165A0 VM1165B0
<b>description</b>	hinge mounting pos. upper door		
<b>For models:</b>	XB1083, XB613G, XB693, XB695, XB813G, XB893, XB895, XBC1005E, XBC1005EL, XBC1015EG, XBC1015EGL, XBC404, XBC405E, XBC604, XBC605E, XBC615EG, XBC804, XBC805E, XBC815EG, XBC905E, XBC905EL, XBC915EG, XBC915EGL, XV1093, XV393, XV513G, XV593, XV813G, XV893, XVC1004P, XVC1005EP, XVC1005EPL, XVC1015EG, XVC1015EGL, XVC1204P, XVC1205EP, XVC1215EG, XVC2005EP, XVC2015EG, XVC204, XVC205E, XVC304, XVC305E, XVC305EP, XVC315EG, XVC315G, XVC4005EP, XVC4005EPL, XVC4015EG, XVC4015EGL...(Other models you can see in the webshop)		

mechanical components, equipment accessories



1

<b>GEV No.</b>	701411	<b>Ref. No.</b>	KVM1236A VM1236A0
<b>description</b>	hinge block L 28mm W 31mm mounting pos. lower UNOX		
<b>For models:</b>	XBC404, XBC604, XBC605, XBC804, XBC805, XBC815G, XVC1204P, XVC2015G, XVC204, XVC205, XVC304, XVC305, XVC315G, XVC504, XVC505, XVC514G, XVC515G, XVC704, XVC705, XVC715G		



1

<b>GEV No.</b>	701409	<b>Ref. No.</b>	EKVM0012A EVM0012A KVM1230A KVM1231A VM1231A0	
<b>description</b>	mounting set for inner door UNOX			
<b>For models:</b>	XB693, XB893, XBC404, XBC604, XBC605, XBC804, XBC805, XBC815G, XV593, XVC1204P, XVC2015G, XVC204, XVC205, XVC304, XVC305, XVC315G, XVC504, XVC505, XVC514G, XVC515G, XVC704, XVC705, XVC715G, XVC905P			
<b>spare parts for</b>	701409			
	<b>GEV No.</b>	694984	<b>Ref. No.</b>	GN1180A0 KGN1180A
protector hinge L 95mm W 65mm Qty 4 pcs				

### bolting feet



1

<b>GEV No.</b>	691521	<b>Ref. No.</b>	KPD1001A PD1000A0 PD1001A0
<b>description</b>	equipment foot ømm L 35mm W 35mm H 37mm bore ø 8mm mounting distancemm Qty 4 pcs		
<b>For models:</b>	XBC404, XBC604, XBC605, XBC804, XBC805, XBC815G, XC224, XC314, XF003, XF023, XF043, XF100, XF103, XF110, XF113, XF115, XF119, XF130, XF133, XF135, XF183, XF185, XF188, XF190, XF193, XF195, XP010P, XP010PR, XP010PT, XP020, XP020P, XP020PR, XP020PT, XP020R, XP020T, XVC054, XVC104, XVC105, XVC105, XVC204, XVC205, XVC304, XVC305, XVC315G, XVC504, XVC505, XVC514G, XVC515G, XVC704, XVC705, XVC715G		

### shelves and shelf rails

#### grid attachments



1

<b>GEV No.</b>	691518	<b>Ref. No.</b>	GRL1010A0 GRL1010A1 KGRL1010A
<b>description</b>	rack support L 310mm H 250mm mounting pos. left/right		
<b>For models:</b>	XF130, XF133, XF135		



1

<b>GEV No.</b>	691520	<b>Ref. No.</b>	GRL1090A0 KGRL1090A
<b>description</b>	rack support L 320mm H 235mm mounting pos. left/right		
<b>For models:</b>	XF023		

### equipment feet and end caps

#### screw-in feet



1

<b>GEV No.</b>	701317	<b>Ref. No.</b>	D35 KPD1052A PD061 PD1052A0
<b>description</b>	equipment feet kit thread M10 thread L 17mm ø 35mm H 20mm Qty 4 pcs UNOX		
<b>For models:</b>	XB403, XB403G, XB603, XB603G, XB803, XB803G, XL041, XL051, XL091, XV203G, XV303G, XV703G		



1

<b>GEV No.</b>	696596	<b>Ref. No.</b>	PD031 PD1051A0
<b>description</b>	equipment foot thread ø 17.5mm thread L 22mm ø 35mm H 20mm WS Qty 1 pcs suitable for UNOX		
<b>For models:</b>	XF010, XF011, XF020, XF020R, XF030, XF030-TG, XF040, XF050, XF065, XF090P, XP010P, XP010PR, XP010PT, XP010R, XP020, XP020P, XP020PR, XP020PT, XP020R, XP020T, XV201, XV202, XV202E, XV301, XV301E, XV401, XV401E		





1			
<b>GEV No.</b>	691519	<b>Ref. No.</b>	GRL1025A0 KGRL1025A
<b>description</b>	rack support L 570mm H 230mm mounting pos. left/right		
<b>For models:</b>	XF190, XF193, XF195		

**gaskets**

**gaskets for heated units**

**window seals**

1			
<b>GEV No.</b>	901280	<b>Ref. No.</b>	KGN1380A
<b>description</b>	window gasket profile 1625/1876 suitable for UNOX L 2x4m		

1			
<b>GEV No.</b>	901305	<b>Ref. No.</b>	GN100
<b>description</b>	window gasket profile 1876 Qty supplied by meter		
<b>For models:</b>	XB403, XB403G, XB603, XB603G, XB803, XB803G, XBT146, XBT160, XG413, XG413G, XG613, XG613G, XG813, XG813G, XV1003G, XV203G, XV303G, XV703G, XVT203G		

**door seals**

1			
<b>GEV No.</b>	901774	<b>Ref. No.</b>	GN1006A
<b>description</b>	door seal profile 2716 Qty supplied by meter		
<b>For models:</b>	XFT140, XFT200		

1			
<b>GEV No.</b>	902020	<b>Ref. No.</b>	KGN1342C
<b>description</b>	door seal profile 2766		

<b>GEV No.</b>	902478	<b>Ref. No.</b>	GN1389B GN1389C KGN0015A. KGN1389C
<b>description</b>	door seal profile 2766 L 1855mm Qty 1		
<b>For models:</b>	XVC305E, XVC305EP, XVC315EG		

1			
<b>GEV No.</b>	902478	<b>Ref. No.</b>	GN1389B GN1389C KGN0015A. KGN1389C
<b>description</b>	door seal profile 2766 L 1855mm Qty 1		
<b>For models:</b>	XVC305E, XVC305EP, XVC315EG		

<b>GEV No.</b>	902479	<b>Ref. No.</b>	GN1390C KGN1390C
<b>description</b>	door seal profile 2766 L 2250mm Qty 1		
<b>For models:</b>	XVC505E, XVC505EP, XVC515EG		

1			
<b>GEV No.</b>	902479	<b>Ref. No.</b>	GN1390C KGN1390C
<b>description</b>	door seal profile 2766 L 2250mm Qty 1		
<b>For models:</b>	XVC505E, XVC505EP, XVC515EG		

<b>GEV No.</b>	902479	<b>Ref. No.</b>	GN1390C KGN1390C
<b>description</b>	door seal profile 2766 L 2250mm Qty 1		
<b>For models:</b>	XVC505E, XVC505EP, XVC515EG		



<b>GEV No.</b>	902482	<b>Ref. No.</b>	GN1391C KGN1391C
<b>description</b>	door seal profile 2766 L 2520mm Qty 1		
<b>For models:</b>	XVC705E, XVC705EP, XVC715EG		

<b>GEV No.</b>	902477	<b>Ref. No.</b>	GN1343B GN1343C KGN1343C
<b>description</b>	door seal profile 2766 L 3070mm Qty 1		
<b>For models:</b>	XBC805E, XBC815EG, XVC2005EP, XVC2015EG		

<b>GEV No.</b>	901843	<b>Ref. No.</b>	GN1250A0 KGN0015A KGN1388C
<b>description</b>	door seal profile 2766 Qty 1.53m		
<b>For models:</b>	XVC1004P		

<b>GEV No.</b>	901294	<b>Ref. No.</b>	GN1000 GN1000A0 GN1000B0
<b>description</b>	door seal profile 2767 Qty supplied by meter		
<b>For models:</b>	XB403, XB403G, XB603, XB603G, XB803, XB803G, XBC1005, XBC404, XBC604, XBC605, XBC804, XBC805, XBC815G, XBT146, XBT160, XG413G, XG613, XG613G, XG813, XV1003G, XV203G, XV303G, XV703G, XVC1005P, XVC1015G, XVC1204P, XVC2015G, XVC204, XVC205, XVC304, XVC305, XVC504, XVC505, XVC514G, XVC515G, XVC704, XVC705, XVC715G, XVC905P, XVT203G		

<b>GEV No.</b>	902476	<b>Ref. No.</b>	GN1356B KGN1356B
<b>description</b>	door seal profile 2769 L 1370mm Qty 1		
<b>For models:</b>	XVC055E		

<b>GEV No.</b>	902327	<b>Ref. No.</b>	KGN1352A
<b>description</b>	door seal profile 2769 L 1600mm Qty 1		

<b>GEV No.</b>	902475	<b>Ref. No.</b>	GN1036A GN1036B KGN1036B
<b>description</b>	door seal profile 2769 L 1720mm Qty 1		

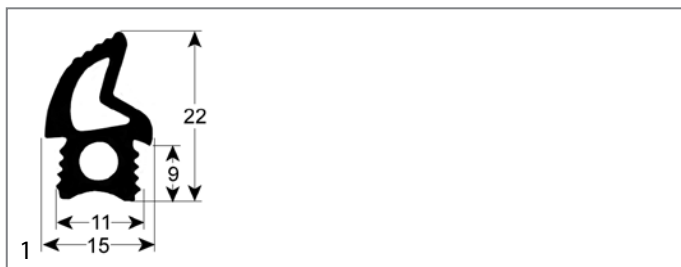

<b>GEV No.</b>	902328	<b>Ref. No.</b>	KG1353A
<b>description</b>	door seal profile 2769 L 1900mm Qty 1		

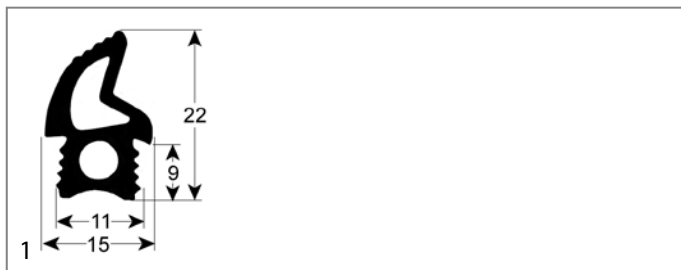

<b>GEV No.</b>	902217	<b>Ref. No.</b>	GN1354A KG1354A
<b>description</b>	door seal profile 2769 L 2030mm Qty 1		
<b>For models:</b>	XFT190, XFT193, XFT195, XFT199, XFT200		



<b>GEV No.</b>	900802	<b>Ref. No.</b>	GN1110A2
<b>description</b>	door seal profile 2769 L 2200mm Qty 1		
<b>For models:</b>	XF113, XF119, XF133, XF135, XF183, XF193, XL405, XVC054, XVC104, XVC105		

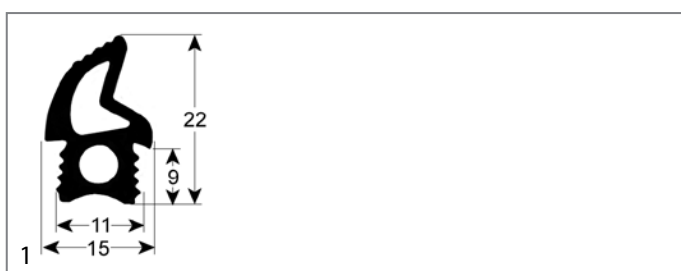

<b>GEV No.</b>	900804	<b>Ref. No.</b>	GN1110A0
<b>description</b>	door seal profile 2769 L 2500mm		
<b>For models:</b>	XCH030, XF100, XF103, XF110, XF115, XF130, XF135, XF185, XF188, XF190, XF195		

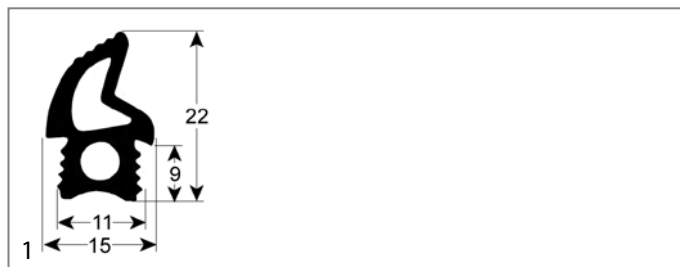

<b>GEV No.</b>	900805	<b>Ref. No.</b>	GN0003A KGN0003A
<b>description</b>	door seal profile 2769 Qty supplied by meter		

door seals with fixing hook



<b>GEV No.</b>	902474	<b>Ref. No.</b>	GN1225A KGN1225A
<b>description</b>	door seal L 330mm W 230mm with 4 mounting clips		

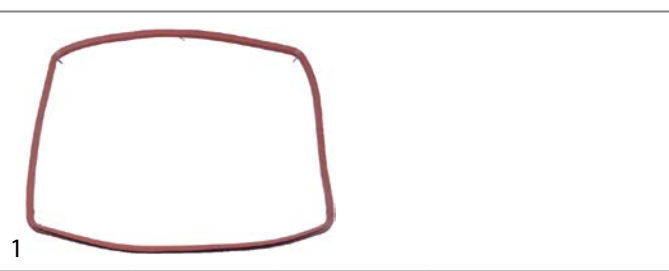

<b>GEV No.</b>	901373	<b>Ref. No.</b>	GN011 KGN011B
<b>description</b>	door seal L 340mm W 270mm with 6 mounting clips		
<b>For models:</b>	XF011		



<b>GEV No.</b>	902330	<b>Ref. No.</b>	GN010
<b>description</b>	door seal L 350mm W 280mm with 4 mounting clips		
<b>For models:</b>	XF010, XF020, XF020R		



1

<b>GEV No.</b>	902329	<b>Ref. No.</b>	GN072 KGN072
<b>description</b>	door seal L 360mm W 220mm with 6 mounting clips		



1

<b>GEV No.</b>	901846	<b>Ref. No.</b>	GN007A GN007B KGN0007B KGN007A KGN007B
<b>description</b>	door seal L 420mm W 790mm 3-sided with mounting clip		



1

<b>GEV No.</b>	901319	<b>Ref. No.</b>	GN021 GN021A GN021B GN021C GN021D KGN021D
<b>description</b>	door seal L 450mm W 350mm with 8 mounting clips		
<b>For models:</b>	XF030, XF030-TG, XF040, XF050, XF065, XV201, XV202, XV202E		



1

<b>GEV No.</b>	902396	<b>Ref. No.</b>	GN1230A GN1230A0 KGN1230A
<b>description</b>	door seal L 460mm W 250mm with 6 mounting clips mounting distance 450x230mmmm suitable for UNOX		



1

<b>GEV No.</b>	900803	<b>Ref. No.</b>	GN1235A GN1235A0 KGN1235A
<b>description</b>	door seal L 480mm W 320mm with 6 mounting clips to be hooked in external size		
<b>For models:</b>	XF023		



1

<b>GEV No.</b>	902397	<b>Ref. No.</b>	GN025A KGN025A
<b>description</b>	door seal L 550mm W 350mm with 6 mounting clips mounting distance 520x310mmmm suitable for UNOX		



1

<b>GEV No.</b>	901307	<b>Ref. No.</b>	GN1260A0 KGN1260A KGN1260A0
<b>description</b>	door seal L 640mm W 290mm with mounting clip		



1

<b>GEV No.</b>	901321	<b>Ref. No.</b>	GN036 GN036A GN036B GN036C GN036D KGN036D
<b>description</b>	door seal L 650mm W 350mm with 8 mounting clips		
<b>For models:</b>	XF090P		



1

<b>GEV No.</b>	901848	<b>Ref. No.</b>	KGNO70
<b>description</b>	door seal W 460mm 4-sided with mounting clip H 210mm		

1

<b>GEV No.</b>	901844	<b>Ref. No.</b>	GN008B GN008C KGN0008C KGN0008D
<b>description</b>	door seal W 640mm 3-sided with mounting clip H 610mm		

1

<b>GEV No.</b>	901847	<b>Ref. No.</b>	GN060 GN060C GN060D KGN060D
<b>description</b>	door seal W 660mm 4-sided with mounting clip H 230mm		

1

<b>GEV No.</b>	901634	<b>Ref. No.</b>	GN046 GN046A GN046B GN046D KGN046D
<b>description</b>	door seal W 660mm with 12 mounting clips H 420mm		
<b>For models:</b>	XV401, XV401E		

1

<b>GEV No.</b>	901845	<b>Ref. No.</b>	KGN1245A
<b>description</b>	door seal W 670mm 3-sided with mounting clip H 520mm		

## special gaskets

### miscellaneous

1

<b>GEV No.</b>	511939	<b>Ref. No.</b>	GN1240A0 KGN1240A
<b>description</b>	gasket external weith 9mm UNOX silicone		
<b>For models:</b>	XF003, XF023, XF043		

1

<b>GEV No.</b>	504474	<b>Ref. No.</b>	GN1190A0
<b>description</b>	gasket suitable for UNOX probes L 40mm W 13mm graphite thickness 1mm		
<b>For models:</b>	XBC404, XBC604, XBC804, XVC054, XVC1004P, XVC104, XVC204, XVC304, XVC504, XVC704		

## springs

### torsion springs

1

<b>GEV No.</b>	371322	<b>Ref. No.</b>	KML0039A RC039
<b>description</b>	spring kit ø 24mm wire gauge ø 3.5mm		
<b>For models:</b>	XP010P, XP010PR, XP010PT, XP010R, XP020, XP020P, XP020PR, XP020PT, XP020R, XP020T		

1

<b>GEV No.</b>	692524	<b>Ref. No.</b>	KML1000A0 RC039A VI093
<b>description</b>	torsion spring set ø 24mm wire gauge ø 3.1mm L1 44mm Qty 1 pcs		
<b>For models:</b>	XP010P, XP010PR, XP010PT, XP010R, XP020, XP020P, XP020PR, XP020PT, XP020R, XP020T		



hoses

industrial hoses

PE hoses

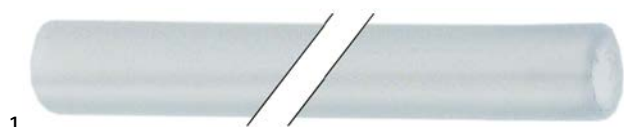

<b>GEV No.</b>	521186	<b>Ref. No.</b>	KTB2529A TB008 TB1815A0
<b>description</b>	hose 0.187" ext. ø 5/16" L 2m operating p. 8-16bar t.max. 65°C LLDPE white ID ø 4.7mm ED ø 8mm John Guest		
<b>For models:</b>	XB403, XB403G, XB603, XB603G, XB803, XB803G, XBC1005, XBC404, XBC604, XBC605, XBC804, XBC805, XBC815G, XBT146, XBT160, XC110, XC111, XC224, XC314, XC400, XC404, XC595, XF113, XF115, XF119, XF133, XF135, XF185, XF188, XF195, XG413, XG413G, XG613, XG613G, XG813, XG813G, XL091, XL314, XL404, XL405, XL504, XL505, XV1003G, XV203G, XV303G, XV703G, XVC054, XVC1004P, XVC1005P, XVC1015G...(Other models you can see in the webshop)		

fittings, hose and pipe connectors

push-in fittings

JOHN GUEST



<b>GEV No.</b>	440015	<b>Ref. No.</b>	RC1002A	
<b>description</b>	push-in fitting John Guest straight pipe connection ø8mm grommet ø 10mm			
<b>For models:</b>	XB613G, XB813G, XB893, XB895, XFT183, XFT185, XFT188, XFT193, XFT195, XFT199, XV513G, XV813G, XV893			
<b>accessories for</b>	440015			
	GEV No.	520972	Ref. No.	—
	hose 6mm ext. ø 8mm L 150m thickness 1mm LLDPE blue ID ø 6mm ED ø 8mm John Guest			



<b>GEV No.</b>	440885	<b>Ref. No.</b>	KEL1195B	
<b>description</b>	push-in fitting DMfit pipe connection ø 8mm grommet ø 8mm			
<b>accessories for</b>	440885			
	GEV No.	520972	Ref. No.	—
	hose 6mm ext. ø 8mm L 150m thickness 1mm LLDPE blue ID ø 6mm ED ø 8mm John Guest			



<b>GEV No.</b>	440671	<b>Ref. No.</b>	EL1195A EL1195A0 KEL1195A KEL1195A0	
<b>description</b>	push-in fitting John Guest angled pipe connection ø8mm grommet ø 8mm			
<b>For models:</b>	XB693, XB695, XB893, XB895, XBC1005, XBC404, XBC604, XBC605, XBC804, XBC805, XBC815G, XC314, XF185, XF188, XF195, XFT183, XFT185, XFT188, XFT193, XFT195, XFT199, XL195, XL404, XL405, XV593, XV893, XVC054, XVC1004P, XVC1005P, XVC1015G, XVC104, XVC105, XVC1204P, XVC2015G, XVC204, XVC205, XVC304, XVC305, XVC315G, XVC504, XVC505, XVC514G, XVC515G, XVC704, XVC705, XVC715G, XVC905P			
<b>accessories for</b>	440671			
	GEV No.	520972	Ref. No.	—
	hose 6mm ext. ø 8mm L 150m thickness 1mm LLDPE blue ID ø 6mm ED ø 8mm John Guest			





<b>GEV No.</b>	440592	<b>Ref. No.</b>	EL1185A EL1185A0 KEL1185A KEL1185B	
<b>description</b>	push-in fitting John Guest angled pipe connection ø8mm - ø8mm			
<b>For models:</b>	XB693, XB695, XB893, XB895, XBC404, XBC405E, XBC604, XBC605, XBC605E, XBC804, XBC805, XBC815G, XC224, XF113, XF119, XF133, XF135, XFT113, XFT115, XFT119, XFT133, XFT135, XV593, XV893, XVC054, XVC1004P, XVC1015G, XVC104, XVC105, XVC1204P, XVC2015G, XVC204, XVC205, XVC304, XVC305, XVC315G, XVC504, XVC505, XVC514G, XVC515G, XVC704, XVC705, XVC715G, XVC905P			
<b>accessories for</b>	440592			
	GEV No.	520972	Ref. No.	—
	hose 6mm ext. ø 8mm L 150m thickness 1mm LLDPE blue ID ø 6mm ED ø 8mm John Guest			



<b>GEV No.</b>	440608	<b>Ref. No.</b>	D0063	
<b>description</b>	push-in fitting John Guest straight thread 1/2" BSP stub ø 10mm			
<b>accessories for</b>	440608			
	GEV No.	520973	Ref. No.	—
	hose 7mm ext. ø 10mm L 100m thickness 1.5mm LLDPE blue John Guest			



			
<b>GEV No.</b>	440014	<b>Ref. No.</b>	EL1125A0
<b>description</b>	push-in fitting John Guest straight thread 1/2" BSP pipe connection ø8mm - ø8mm bulkhead connector		
<b>For models:</b>	XB403, XB403G, XB603, XB603G, XB803, XB803G, XBT146, XBT160, XG413G, XG613, XG613G, XG813, XL135, XL195, XL314, XL404, XL405, XV1003G, XV203G, XV303G, XV703G		
<b>accessories for</b>	440014		
	<b>GEV No.</b>	520972	<b>Ref. No.</b> —
	 hose 6mm ext. ø 8mm L 150m thickness 1mm LLDPE blue ID ø 6mm ED ø 8mm John Guest		

			
<b>GEV No.</b>	440551	<b>Ref. No.</b>	EL1210A0 KEL1210A
<b>description</b>	push-in fitting John Guest straight thread 1/4" BSPT pipe connection ø8mm		
<b>For models:</b>	XBC1005, XBC605, XBC805, XBC815G, XC404, XC595, XVC1005P, XVC1015G, XVC105, XVC205, XVC305, XVC315G, XVC505, XVC514G, XVC515G, XVC705, XVC715G, XVC905P		

			
<b>GEV No.</b>	440028	<b>Ref. No.</b>	KRC1365A RC1210A0 RC1210A1
<b>description</b>	push-in fitting UNOX straight Qty 1 pcs thread 3/4" pipe connection ø8 sealing flat seal		
<b>For models:</b>	XB1083, XB613G, XB693, XB695, XB813G, XB893, XB895, XBC1005, XBC1005E, XBC1005EL, XBC1015EG, XBC1015EGL, XBC605, XBC615EG, XBC805, XBC805E, XBC815EG, XBC815G, XBC905E, XBC905EL, XBC915EG, XBC915EGL, XFT140, XFT183, XFT185, XFT188, XFT193, XFT195, XFT199, XFT200, XV1093, XV393, XV513G, XV593, XV813G, XV893, XVC055E, XVC1005EP, XVC1005EPL, XVC1005P, XVC1015EG, XVC1015EGL, XVC1015G, XVC105, XVC105E, XVC105EP, XVC1204P, XVC1205EP, XVC1215EG, XVC2005EP...(Other models you can see in the webshop)		

<b>DMfit</b>			
			
<b>GEV No.</b>	440857	<b>Ref. No.</b>	D0064 EL022 EL1055A0 KEL1055A
<b>description</b>	push-in fitting DMfit straight pipe connection ø8mm - ø10mm		
<b>For models:</b>	XB403, XB403G, XB603, XB603G, XB803, XB803G, XBC404, XBC604, XBC605, XBC804, XBC805, XBC815G, XBT146, XBT160, XC110, XC111, XF090P, XF113, XF115, XF119, XF133, XF135, XF185, XF188, XF195, XG413, XG413G, XG613, XG613G, XG813, XG813G, XL041, XL091, XL503, XV1003G, XV202, XV202E, XV203G, XV301, XV301E, XV303G, XV401, XV401E, XV501, XV501E, XV703G, XVC054, XVC104, XVC105, XVC1204P...(Other models you can see in the webshop)		

			
<b>GEV No.</b>	440822	<b>Ref. No.</b>	EL1020A0 KEL1020A
<b>description</b>	push-in fitting DMfit T-piece pipe connection ø8mm - ø8mm - ø8mm		
<b>For models:</b>	XBC404, XBC604, XBC605, XBC804, XBC805, XBC815G, XL405, XVC1204P, XVC2015G, XVC205, XVC305, XVC505, XVC515G, XVC705, XVC715G		

## water filters

### miscellaneous

			
<b>GEV No.</b>	530438	<b>Ref. No.</b>	KVL1034A KVL1034B KVL1034C VL1034A0
<b>description</b>	water filter operation p max 11 bar water temperature 65°C for external tube ø (A) 8mm (B) 8mm		

			
<b>GEV No.</b>	530439	<b>Ref. No.</b>	VL1034A
<b>description</b>	water filter type ADMF1010M operation p max 10 bar water temperature 65°C for external tube ø (A) 10mm (B) 10mm		
<b>For models:</b>	XB1083, XB613G, XB693, XB695, XB813G, XB893, XB895, XBC1005E, XBC1005EL, XBC1015EG, XBC1015EGL, XBC405E, XBC605E, XBC615EG, XBC805E, XBC815EG, XBC905E, XBC905EL, XBC915EG, XBC915EGL, XFT140, XFT200, XV1093, XV513G, XV593, XV813G, XV893, XVC055E, XVC1005EP, XVC1005EPL, XVC1015EG, XVC1015EGL, XVC105E, XVC105EP, XVC1205EP, XVC1215EG, XVC2005EP, XVC2015EG, XVC205E, XVC305E, XVC305EP, XVC315EG, XVC4005EP, XVC4005EPL, XVC4015EG, XVC4015EGL, XVC505E, XVC505EP, XVC515EG, XVC705E...(Other models you can see in the webshop)		



## beverage technology

### valves

#### non-return valves



1

<b>GEV No.</b>	440729	<b>Ref. No.</b>	KEL1180A
<b>description</b>	non-return valve John Guest pipe connection 5/16" - 5/16" operating pressure at 20°C 10bar opening pressure 0.02bar POM for hose ø 8mm		
<b>accessories for</b>	440729		
	<b>GEV No.</b>	<b>Ref. No.</b>	—
	hose 6mm ext. ø 8mm L 10m thickness 1mm LLDPE blue ID ø 6mm ED ø 8mm John Guest		

## water cycle components

### pressure reduction valves

#### pressure reduction valves

##### universal



1

<b>GEV No.</b>	520890	<b>Ref. No.</b>	D0061
<b>description</b>	pressure reduction valve Caleffi series 5330 connection 1/2" default setting 2bar setting range 1-6bar p max 16bar t.max. 40°C angle seat chrome-plated brass WRAS/ACS		



1

<b>GEV No.</b>	520889 <sup>1</sup>	<b>Ref. No.</b>	EL1370A0 KEL1370A
<b>description</b>	pressure reduction valve Caleffi series 5330 connection 1/2" default setting 2bar setting range 1-6bar p max 16bar t.max. 40°C set chrome-plated brass WRAS/ACS		
<b>For models:</b>	XBC1005, XBC605, XBC805, XBC815G, XVC1005P, XVC1015G, XVC105, XVC2015G, XVC205, XVC305, XVC315G, XVC505, XVC514G, XVC515G, XVC705, XVC715G, XVC905P		

<sup>1</sup>incl. 2x John Guest hose connectors 10mm and 2x John Guest push-in fittings

### producer-specific



1

<b>GEV No.</b>	520998	<b>Ref. No.</b>	KVL1014A
<b>description</b>	pressure reduction valve connection John Guest 8mm 90° p max 2.30bar T-piece plastic connection 1: 8 plug-in connectionmm connection 2: 10 plug-in connectionmm black		
<b>For models:</b>	XB1083, XBC1005E, XBC1005EL, XBC1015EG, XBC1015EGL, XBC405E, XBC605E, XBC615EG, XBC805E, XBC815EG, XBC905E, XBC905EL, XBC915EG, XBC915EGL, XFT140, XFT200, XV1093, XVC055E, XVC1005EP, XVC1005EPL, XVC1015EG, XVC1015EGL, XVC105E, XVC105EP, XVC1205EP, XVC1215EG, XVC2005EP, XVC2015EG, XVC205E, XVC305E, XVC305EP, XVC315EG, XVC4005EP, XVC4005EPL, XVC4015EG, XVC4015EGL, XVC505E, XVC505EP, XVC515EG, XVC705E, XVC705EP, XVC715EG, XVC905EP, XVC905EPL, XVC915EG, XVC915EGL		



1

<b>GEV No.</b>	520997	<b>Ref. No.</b>	KVL0010A
<b>description</b>	pressure reduction valve connection John Guest 8mm p max 2.30bar plastic black		

## tools

### cleaning tools

#### scrapers



1

<b>GEV No.</b>	890049	<b>Ref. No.</b>	KVM1000A
<b>description</b>	scraper for ceramic hobs		
<b>spare parts for</b>	890049		
	<b>GEV No.</b>	<b>Ref. No.</b>	—
	spare blades for scraper Qty 10 pcs		





## fastening material

### screws

#### grub screws

DIN 914/ISO 4027



<b>GEV No.</b>	504868	<b>Ref. No.</b>	KVI1740A KVI1740A0
<b>description</b>	grub screw thread M4 L 6mm stainless steel DIN 914 intake hexagonal WS 2 Qty 20 pcs		

### nuts

#### hexagonal nuts

DIN 985



<b>GEV No.</b>	560142	<b>Ref. No.</b>	KVI0001A
<b>description</b>	hexagonal nut thread M6 H 6mm SS WS 10 Qty 20 pcs DIN/ISO DIN 985 self-locking		

## consumables

### sealants and adhesives

#### high temperature silicone



<b>GEV No.</b>	890050	<b>Ref. No.</b>	KSL1170A
<b>description</b>	high temperature silicone NOVASIL S76 acetoxy-curing -40 up to +265°C t.max. 280°C anthracite cartridge 310ml		
<b>description</b>	Novasil S56 - cartridge 310ml - anthracite - Developed for applications in the home appliance industry: - Gluing of oven door seals - Gluing of mounting brackets for cooker fascias, oven door seals and handles - Attachment of elastic seals, e.g. to oven doors Temperature resistance: -40°C to +265°C		

### cleaning agents

#### combisteamer detergents/descalers

Notice: Articles labelled 'DANGEROUS GOODS' are delivered by road through a forwarder for reasons of safety and are charged separately!



<b>GEV No.</b>	802096	<b>Ref. No.</b>	DB1011A0 DB1016A0
<b>description</b>	detergent for combi-steamer UNOX UNOX.Det&Rinse For Rotor. KLEAN 2x5l		
<b>description</b>	UNOX Det & Rinse - Cleaner - Canister 2x5l with integrated rinse aid for washing system RotorKlean -E series from 07/2012		

**DANGEROUS GOODS**

### fuses

#### fine fuses



<b>GEV No.</b>	358373	<b>Ref. No.</b>	VG1001A0
<b>description</b>	fine fuse size ø5x20mm 1.6A fast-acting rated 250V		
<b>For models:</b>	XVC1015G, XVC315G		

#### fine fuse holders



<b>GEV No.</b>	358177	<b>Ref. No.</b>	KVG1000A VE301
<b>description</b>	fuse holder suitable fuse ø5x20mm ø 16mm mounting ø 13mm 1-pole 6.3A rated 250V L 54mm connection male faston 6.3mm		
<b>For models:</b>	XG413G, XG613, XG613G, XG813, XG813G		



<b>A</b>			
alarm devices	18		
axial fans	26		
<b>B</b>			
beverage technology	48		
booster pumps II	29		
<b>C</b>			
cables	30		
cleaning agents	49		
cleaning tools	48		
combisteamer detergents/descalers	49		
condensators & interference suppression filters	29		
connection cables	30		
consumables	49		
contactors	19		
control thermostats	7		
<b>D</b>			
door seals	41		
door seals with fixing hook	43		
<b>E</b>			
electric accessories	30		
electronic controllers	20		
energy regulators	7		
espagnolette locks	37		
<b>F</b>			
fans	26		
fastening material	49		
fine fuses	49		
fuses	29, 49		
<b>G</b>			
gas burners	33		
gas control valves	31		
gaskets for heated units	41		
GEV	2		
grub screws	49		
<b>H</b>			
Hall sensors	22		
halogen lamp	16		
heating elements	2		
heating elements for convection	2		
heating elements for ovens	2		
hexagonal nuts	49		
high temperature silicone	49		
hoses	46		
hot air fans	28		
hot air motors	26		
<b>I</b>			
ignition boxes	32		
ignition units	33		
indicator lights	15		
indicator lights (complete)	15		
industrial hoses	46		
<b>L</b>			
lamps	15		
LED	15		
<b>M</b>			
mechanical timers	18		
motors	28		
<b>N</b>			
non-return valves	48		
nuts	49		
<b>O</b>			
operating capacitors	29		
oven hinges	37		
oven lamps	16		
<b>P</b>			
PE hoses	46		
power supply cables	30		
pressure reduction valves	48, 48		
probes	20		
programme timers	18		
pumps	29		
push-in fittings	46		
<b>R</b>			
radial fans	28		
ribbon cables	30		
<b>S</b>			
safety thermostats	8		
screws	49		
sealants and adhesives	49		
shelves and shelf rails	40		
silicone	49		
solenoid valves	24		
switches and momentary switches	9		
<b>T</b>			
terminals	30		
thermostats	7		
timers	18		
tools	48		

transformers 19

## V

valves 48

vibration pumps 29

## W

water cycle components 48

water filters 47

window seals 41