







| Assembly code | Assembly revision | Assembly image |
|----------------|-------------------|---|
| ASM2825A/0.D00 | General overview |  |
| ASM1312A/0.D02 | General overview |  |
| ASM1333A/0.D00 | General overview |  |
| ASM1311A/0.D01 | External cover |  |



ASM2825A/0.D00 - General overview

FRONT





ASM2825A/0.D00 - General overview

REAR

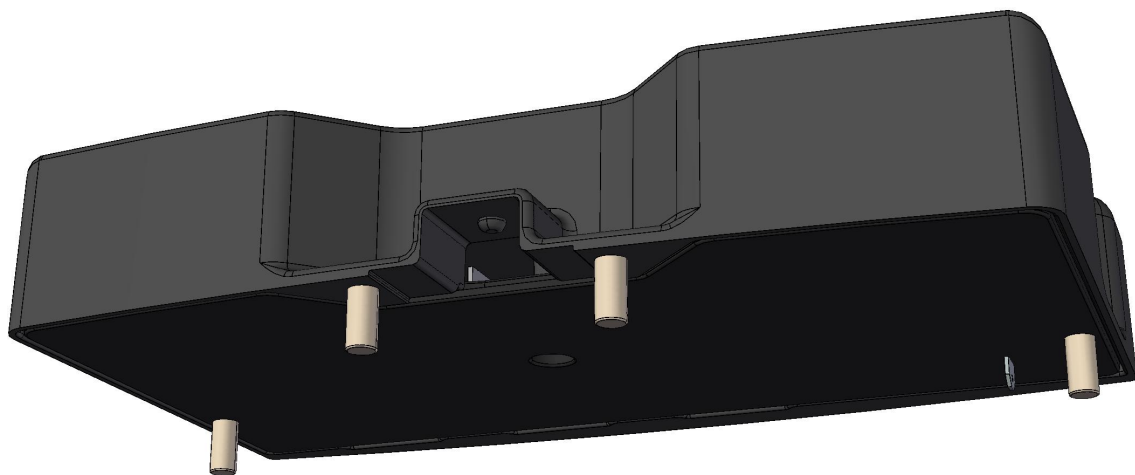



| COMPONENT | | | SPARE PART | | | | | | | | | | | | | | | | | | | | | | |
|-----------|--------------------------------------|---|------------|--|--|------|-------------|-----|-----|----------|--------------------------------------|---|----|----------|--------------------------------|---|----|----------|--------------------------------------|---|----|----------|-------------------------------|---|----|
| Code | Description | Image | Code | Description | Components list | | | | | | | | | | | | | | | | | | | | |
| TR1141A | 2-72°C SAFETY THERMOSTAT |  | KTR1141A | 2-72°C SAFETY THERMOSTAT KIT | <table border="1"> <thead> <tr> <th>Code</th> <th>Description</th> <th>Qty</th> <th>UOM</th> </tr> </thead> <tbody> <tr> <td>TR1141A0</td> <td>2-72°C SAFETY THERMOSTAT</td> <td>1</td> <td>PZ</td> </tr> <tr> <td>VI1850A0</td> <td>M4X6 NICKEL PLATED FIXING SCRE</td> <td>2</td> <td>PZ</td> </tr> </tbody> </table> | Code | Description | Qty | UOM | TR1141A0 | 2-72°C SAFETY THERMOSTAT | 1 | PZ | VI1850A0 | M4X6 NICKEL PLATED FIXING SCRE | 2 | PZ | | | | | | | | |
| Code | Description | Qty | UOM | | | | | | | | | | | | | | | | | | | | | | |
| TR1141A0 | 2-72°C SAFETY THERMOSTAT | 1 | PZ | | | | | | | | | | | | | | | | | | | | | | |
| VI1850A0 | M4X6 NICKEL PLATED FIXING SCRE | 2 | PZ | | | | | | | | | | | | | | | | | | | | | | |
| VM1019B | MANUAL PROOVER PLASTIC CONTROL PANEL |  | KVM1019B | MANUAL PROOVER CONTROL BOARD KIT | <table border="1"> <thead> <tr> <th>Code</th> <th>Description</th> <th>Qty</th> <th>UOM</th> </tr> </thead> <tbody> <tr> <td>MS1018B0</td> <td>MANUAL PROOVER CONTROL BOARD STICKER</td> <td>1</td> <td>PZ</td> </tr> <tr> <td>VE1585A0</td> <td>BLUE LIGHT COVER GOLD SINUSOID</td> <td>1</td> <td>PZ</td> </tr> <tr> <td>VM1019B0</td> <td>MANUAL PROOVER PLASTIC CONTROL PANEL</td> <td>1</td> <td>PZ</td> </tr> <tr> <td>VM2009A0</td> <td>ELLIPTICAL SILVER SUPPORT D16</td> <td>3</td> <td>PZ</td> </tr> </tbody> </table> | Code | Description | Qty | UOM | MS1018B0 | MANUAL PROOVER CONTROL BOARD STICKER | 1 | PZ | VE1585A0 | BLUE LIGHT COVER GOLD SINUSOID | 1 | PZ | VM1019B0 | MANUAL PROOVER PLASTIC CONTROL PANEL | 1 | PZ | VM2009A0 | ELLIPTICAL SILVER SUPPORT D16 | 3 | PZ |
| Code | Description | Qty | UOM | | | | | | | | | | | | | | | | | | | | | | |
| MS1018B0 | MANUAL PROOVER CONTROL BOARD STICKER | 1 | PZ | | | | | | | | | | | | | | | | | | | | | | |
| VE1585A0 | BLUE LIGHT COVER GOLD SINUSOID | 1 | PZ | | | | | | | | | | | | | | | | | | | | | | |
| VM1019B0 | MANUAL PROOVER PLASTIC CONTROL PANEL | 1 | PZ | | | | | | | | | | | | | | | | | | | | | | |
| VM2009A0 | ELLIPTICAL SILVER SUPPORT D16 | 3 | PZ | | | | | | | | | | | | | | | | | | | | | | |
| VM1028A | MANUAL PROOVER CONTROL BOARD TRAY |  | KVM1028A | MANUAL PROOVER CONTROL BOARD TRAY VM1028 | <table border="1"> <thead> <tr> <th>Code</th> <th>Description</th> <th>Qty</th> <th>UOM</th> </tr> </thead> <tbody> <tr> <td>VM1028A0</td> <td>MANUAL PROOVER CONTROL BOARD TRAY</td> <td>1</td> <td>PZ</td> </tr> </tbody> </table> | Code | Description | Qty | UOM | VM1028A0 | MANUAL PROOVER CONTROL BOARD TRAY | 1 | PZ | | | | | | | | | | | | |
| Code | Description | Qty | UOM | | | | | | | | | | | | | | | | | | | | | | |
| VM1028A0 | MANUAL PROOVER CONTROL BOARD TRAY | 1 | PZ | | | | | | | | | | | | | | | | | | | | | | |
| MN1003A | PROOVER THERMOSTAT 0-70°C KNOB |  | MN1003A0 | PROOVER THERMOSTAT 0-70°C KNOB | | | | | | | | | | | | | | | | | | | | | |

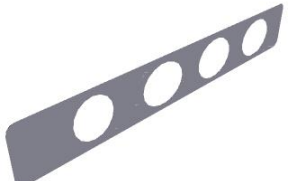
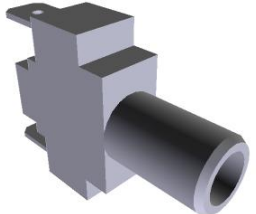

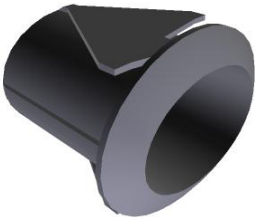

| COMPONENT | | | SPARE PART | | | | | | | | | | | | | | | | | | | | | | | | | | | | | | |
|-----------|--------------------------------------|---|----------------|------------------------------|---|------|-------------|-----|-----|----------|--------------------------------------|---|----|----------|------------------------------|---|----|----------|---------------------------------|---|----|----------|-------------------------------------|---|----|----------|------------------------------|---|----|----------|--------------------|---|----|
| Code | Description | Image | Code | Description | Components list | | | | | | | | | | | | | | | | | | | | | | | | | | | | |
| MS1018B | MANUAL PROOFER CONTROL BOARD STICKER |  | OUTOFPRODUCTIO | | | | | | | | | | | | | | | | | | | | | | | | | | | | | | |
| VE1562A | UNIPOLAR NA PUSH BUTTON |  | KVE0107A | SILVER CLOUD LIGHT COVER KIT | <table border="1"> <thead> <tr> <th>Code</th> <th>Description</th> <th>Qty</th> <th>UOM</th> </tr> </thead> <tbody> <tr> <td>VE1170A0</td> <td>D16 OPAQUE NICKEL ELLIPTICAL SUPPORT</td> <td>1</td> <td>PZ</td> </tr> <tr> <td>VE1562A0</td> <td>UNIPOLAR NA PUSH BUTTO</td> <td>1</td> <td>PZ</td> </tr> <tr> <td>VM1761A0</td> <td>D16 BLACK ELLIPTICAL SUPPORT</td> <td>1</td> <td>PZ</td> </tr> <tr> <td>VM1775A0</td> <td>OPAQUE SILVER KEY WITH GOLD "CLOUD"</td> <td>1</td> <td>PZ</td> </tr> </tbody> </table> | Code | Description | Qty | UOM | VE1170A0 | D16 OPAQUE NICKEL ELLIPTICAL SUPPORT | 1 | PZ | VE1562A0 | UNIPOLAR NA PUSH BUTTO | 1 | PZ | VM1761A0 | D16 BLACK ELLIPTICAL SUPPORT | 1 | PZ | VM1775A0 | OPAQUE SILVER KEY WITH GOLD "CLOUD" | 1 | PZ | | | | | | | | |
| Code | Description | Qty | UOM | | | | | | | | | | | | | | | | | | | | | | | | | | | | | | |
| VE1170A0 | D16 OPAQUE NICKEL ELLIPTICAL SUPPORT | 1 | PZ | | | | | | | | | | | | | | | | | | | | | | | | | | | | | | |
| VE1562A0 | UNIPOLAR NA PUSH BUTTO | 1 | PZ | | | | | | | | | | | | | | | | | | | | | | | | | | | | | | |
| VM1761A0 | D16 BLACK ELLIPTICAL SUPPORT | 1 | PZ | | | | | | | | | | | | | | | | | | | | | | | | | | | | | | |
| VM1775A0 | OPAQUE SILVER KEY WITH GOLD "CLOUD" | 1 | PZ | | | | | | | | | | | | | | | | | | | | | | | | | | | | | | |
| | | | KVE0106A | SILVER FLAME LIGHT COVER KIT | <table border="1"> <thead> <tr> <th>Code</th> <th>Description</th> <th>Qty</th> <th>UOM</th> </tr> </thead> <tbody> <tr> <td>VE1562A0</td> <td>UNIPOLAR NA PUSH BUTTO</td> <td>1</td> <td>PZ</td> </tr> <tr> <td>VM1761A0</td> <td>D16 BLACK ELLIPTICAL SUPPORT</td> <td>1</td> <td>PZ</td> </tr> <tr> <td>VM1774A0</td> <td>SILVER OPAQUE KEY W/ GOLD FLAME</td> <td>1</td> <td>PZ</td> </tr> </tbody> </table> | Code | Description | Qty | UOM | VE1562A0 | UNIPOLAR NA PUSH BUTTO | 1 | PZ | VM1761A0 | D16 BLACK ELLIPTICAL SUPPORT | 1 | PZ | VM1774A0 | SILVER OPAQUE KEY W/ GOLD FLAME | 1 | PZ | | | | | | | | | | | | |
| Code | Description | Qty | UOM | | | | | | | | | | | | | | | | | | | | | | | | | | | | | | |
| VE1562A0 | UNIPOLAR NA PUSH BUTTO | 1 | PZ | | | | | | | | | | | | | | | | | | | | | | | | | | | | | | |
| VM1761A0 | D16 BLACK ELLIPTICAL SUPPORT | 1 | PZ | | | | | | | | | | | | | | | | | | | | | | | | | | | | | | |
| VM1774A0 | SILVER OPAQUE KEY W/ GOLD FLAME | 1 | PZ | | | | | | | | | | | | | | | | | | | | | | | | | | | | | | |
| | | | KVE0008A | XL PILOT BLUE LIGHTS KIT | <table border="1"> <thead> <tr> <th>Code</th> <th>Description</th> <th>Qty</th> <th>UOM</th> </tr> </thead> <tbody> <tr> <td>VE1530A0</td> <td>GOLD THERMOMETE R BLUE LIGHT COVER</td> <td>1</td> <td>PZ</td> </tr> <tr> <td>VE1535A1</td> <td>230V WHITE LED</td> <td>1</td> <td>PZ</td> </tr> <tr> <td>VE1561A0</td> <td>NA/NA BIPOLAR SWITCH</td> <td>1</td> <td>PZ</td> </tr> <tr> <td>VE1562A0</td> <td>UNIPOLAR NA PUSH BUTTO</td> <td>1</td> <td>PZ</td> </tr> <tr> <td>VM1761A0</td> <td>D16 BLACK ELLIPTICAL SUPPORT</td> <td>3</td> <td>PZ</td> </tr> <tr> <td>VM1762A0</td> <td>INNER LAMP SUPPORT</td> <td>1</td> <td>PZ</td> </tr> </tbody> </table> | Code | Description | Qty | UOM | VE1530A0 | GOLD THERMOMETE R BLUE LIGHT COVER | 1 | PZ | VE1535A1 | 230V WHITE LED | 1 | PZ | VE1561A0 | NA/NA BIPOLAR SWITCH | 1 | PZ | VE1562A0 | UNIPOLAR NA PUSH BUTTO | 1 | PZ | VM1761A0 | D16 BLACK ELLIPTICAL SUPPORT | 3 | PZ | VM1762A0 | INNER LAMP SUPPORT | 1 | PZ |
| Code | Description | Qty | UOM | | | | | | | | | | | | | | | | | | | | | | | | | | | | | | |
| VE1530A0 | GOLD THERMOMETE R BLUE LIGHT COVER | 1 | PZ | | | | | | | | | | | | | | | | | | | | | | | | | | | | | | |
| VE1535A1 | 230V WHITE LED | 1 | PZ | | | | | | | | | | | | | | | | | | | | | | | | | | | | | | |
| VE1561A0 | NA/NA BIPOLAR SWITCH | 1 | PZ | | | | | | | | | | | | | | | | | | | | | | | | | | | | | | |
| VE1562A0 | UNIPOLAR NA PUSH BUTTO | 1 | PZ | | | | | | | | | | | | | | | | | | | | | | | | | | | | | | |
| VM1761A0 | D16 BLACK ELLIPTICAL SUPPORT | 3 | PZ | | | | | | | | | | | | | | | | | | | | | | | | | | | | | | |
| VM1762A0 | INNER LAMP SUPPORT | 1 | PZ | | | | | | | | | | | | | | | | | | | | | | | | | | | | | | |

| COMPONENT | | | SPARE PART | | | | | | | | | | | | | | | | | | | | | | | | | | | | | | | | | | | | | | | | | | | | | | | |
|-----------|--------------------------------------|--|------------|------------------------------|--|------|-------------|------------------------------------|-----|----------|--------------------------------------|----------------|----|----------|----------------------------|------------------------|----|----------|------------------------------|--------------------------------|----|----------|-------------------------------------|------------------------------|----|----|----------|--------------------|---|----|----------|---------------------------------|---|----|----------|---------------------------------|---|----|----------|-------------------------------------|---|----|----------|---------------------------------|---|----|----------|-------------------------------|---|----|
| Code | Description | Image | Code | Description | Components list | | | | | | | | | | | | | | | | | | | | | | | | | | | | | | | | | | | | | | | | | | | | | |
| VE1562A | UNIPOLAR NA PUSH BUTTON |  | KVE0008A | XL PILOT BLUE LIGHTS KIT | <table border="1"> <thead> <tr> <th>Code</th> <th>Description</th> <th>Qty</th> <th>UOM</th> </tr> </thead> <tbody> <tr> <td>VM1775A0</td> <td>OPAQUE SILVER KEY WITH GOLD "CLOUD"</td> <td>1</td> <td>PZ</td> </tr> <tr> <td>VM1776A0</td> <td>GOLD "0-1" MATT SILVER KEY</td> <td>1</td> <td>PZ</td> </tr> </tbody> </table> | Code | Description | Qty | UOM | VM1775A0 | OPAQUE SILVER KEY WITH GOLD "CLOUD" | 1 | PZ | VM1776A0 | GOLD "0-1" MATT SILVER KEY | 1 | PZ | | | | | | | | | | | | | | | | | | | | | | | | | | | | | | | | | |
| | | | Code | Description | Qty | UOM | | | | | | | | | | | | | | | | | | | | | | | | | | | | | | | | | | | | | | | | | | | | |
| VM1775A0 | OPAQUE SILVER KEY WITH GOLD "CLOUD" | 1 | PZ | | | | | | | | | | | | | | | | | | | | | | | | | | | | | | | | | | | | | | | | | | | | | | | |
| VM1776A0 | GOLD "0-1" MATT SILVER KEY | 1 | PZ | | | | | | | | | | | | | | | | | | | | | | | | | | | | | | | | | | | | | | | | | | | | | | | |
| KVE0007A | XF-XG LED AND LED COVERS KIT | <table border="1"> <thead> <tr> <th>Code</th> <th>Description</th> <th>Qty</th> <th>UOM</th> </tr> </thead> <tbody> <tr> <td>VE1530A0</td> <td>GOLD THERMOMETE R BLUE LIGHT COVER</td> <td>1</td> <td>PZ</td> </tr> <tr> <td>VE1535A1</td> <td>230V WHITE LED</td> <td>1</td> <td>PZ</td> </tr> <tr> <td>VE1562A0</td> <td>UNIPOLAR NA PUSH BUTTO</td> <td>1</td> <td>PZ</td> </tr> <tr> <td>VE1585A0</td> <td>BLUE LIGHT COVER GOLD SINUSOID</td> <td>1</td> <td>PZ</td> </tr> <tr> <td>VM1761A0</td> <td>D16 BLACK ELLIPTICAL SUPPORT</td> <td>5</td> <td>PZ</td> </tr> <tr> <td>VM1762A0</td> <td>INNER LAMP SUPPORT</td> <td>4</td> <td>PZ</td> </tr> <tr> <td>VM1767A0</td> <td>GREEN PILOT LIGHT W/ GOLD FLAME</td> <td>1</td> <td>PZ</td> </tr> <tr> <td>VM1774A0</td> <td>SILVER OPAQUE KEY W/ GOLD FLAME</td> <td>1</td> <td>PZ</td> </tr> <tr> <td>VM1775A0</td> <td>OPAQUE SILVER KEY WITH GOLD "CLOUD"</td> <td>1</td> <td>PZ</td> </tr> <tr> <td>VM1902A0</td> <td>NEUTRAL GREEN PLASTIC COVER FOR</td> <td>1</td> <td>PZ</td> </tr> <tr> <td>VM1903A0</td> <td>GREEN PILOT WITH GOLD "CLOUD"</td> <td>1</td> <td>PZ</td> </tr> </tbody> </table> | Code | Description | Qty | UOM | VE1530A0 | GOLD THERMOMETE R BLUE LIGHT COVER | 1 | PZ | VE1535A1 | 230V WHITE LED | 1 | PZ | VE1562A0 | UNIPOLAR NA PUSH BUTTO | 1 | PZ | VE1585A0 | BLUE LIGHT COVER GOLD SINUSOID | 1 | PZ | VM1761A0 | D16 BLACK ELLIPTICAL SUPPORT | 5 | PZ | VM1762A0 | INNER LAMP SUPPORT | 4 | PZ | VM1767A0 | GREEN PILOT LIGHT W/ GOLD FLAME | 1 | PZ | VM1774A0 | SILVER OPAQUE KEY W/ GOLD FLAME | 1 | PZ | VM1775A0 | OPAQUE SILVER KEY WITH GOLD "CLOUD" | 1 | PZ | VM1902A0 | NEUTRAL GREEN PLASTIC COVER FOR | 1 | PZ | VM1903A0 | GREEN PILOT WITH GOLD "CLOUD" | 1 | PZ |
| Code | Description | Qty | UOM | | | | | | | | | | | | | | | | | | | | | | | | | | | | | | | | | | | | | | | | | | | | | | | |
| VE1530A0 | GOLD THERMOMETE R BLUE LIGHT COVER | 1 | PZ | | | | | | | | | | | | | | | | | | | | | | | | | | | | | | | | | | | | | | | | | | | | | | | |
| VE1535A1 | 230V WHITE LED | 1 | PZ | | | | | | | | | | | | | | | | | | | | | | | | | | | | | | | | | | | | | | | | | | | | | | | |
| VE1562A0 | UNIPOLAR NA PUSH BUTTO | 1 | PZ | | | | | | | | | | | | | | | | | | | | | | | | | | | | | | | | | | | | | | | | | | | | | | | |
| VE1585A0 | BLUE LIGHT COVER GOLD SINUSOID | 1 | PZ | | | | | | | | | | | | | | | | | | | | | | | | | | | | | | | | | | | | | | | | | | | | | | | |
| VM1761A0 | D16 BLACK ELLIPTICAL SUPPORT | 5 | PZ | | | | | | | | | | | | | | | | | | | | | | | | | | | | | | | | | | | | | | | | | | | | | | | |
| VM1762A0 | INNER LAMP SUPPORT | 4 | PZ | | | | | | | | | | | | | | | | | | | | | | | | | | | | | | | | | | | | | | | | | | | | | | | |
| VM1767A0 | GREEN PILOT LIGHT W/ GOLD FLAME | 1 | PZ | | | | | | | | | | | | | | | | | | | | | | | | | | | | | | | | | | | | | | | | | | | | | | | |
| VM1774A0 | SILVER OPAQUE KEY W/ GOLD FLAME | 1 | PZ | | | | | | | | | | | | | | | | | | | | | | | | | | | | | | | | | | | | | | | | | | | | | | | |
| VM1775A0 | OPAQUE SILVER KEY WITH GOLD "CLOUD" | 1 | PZ | | | | | | | | | | | | | | | | | | | | | | | | | | | | | | | | | | | | | | | | | | | | | | | |
| VM1902A0 | NEUTRAL GREEN PLASTIC COVER FOR | 1 | PZ | | | | | | | | | | | | | | | | | | | | | | | | | | | | | | | | | | | | | | | | | | | | | | | |
| VM1903A0 | GREEN PILOT WITH GOLD "CLOUD" | 1 | PZ | | | | | | | | | | | | | | | | | | | | | | | | | | | | | | | | | | | | | | | | | | | | | | | |
| VM1775A | OPAQUE SILVER KEY WITH GOLD "CLOUD" |  | KVE0107A | SILVER CLOUD LIGHT COVER KIT | <table border="1"> <thead> <tr> <th>Code</th> <th>Description</th> <th>Qty</th> <th>UOM</th> </tr> </thead> <tbody> <tr> <td>VE1170A0</td> <td>D16 OPAQUE NICKEL ELLIPTICAL SUPPORT</td> <td>1</td> <td>PZ</td> </tr> <tr> <td>VE1562A0</td> <td>UNIPOLAR NA PUSH BUTTO</td> <td>1</td> <td>PZ</td> </tr> <tr> <td>VM1761A0</td> <td>D16 BLACK ELLIPTICAL SUPPORT</td> <td>1</td> <td>PZ</td> </tr> <tr> <td>VM1775A0</td> <td>OPAQUE SILVER KEY WITH GOLD "CLOUD"</td> <td>1</td> <td>PZ</td> </tr> </tbody> </table> | Code | Description | Qty | UOM | VE1170A0 | D16 OPAQUE NICKEL ELLIPTICAL SUPPORT | 1 | PZ | VE1562A0 | UNIPOLAR NA PUSH BUTTO | 1 | PZ | VM1761A0 | D16 BLACK ELLIPTICAL SUPPORT | 1 | PZ | VM1775A0 | OPAQUE SILVER KEY WITH GOLD "CLOUD" | 1 | PZ | | | | | | | | | | | | | | | | | | | | | | | | | |
| Code | Description | Qty | UOM | | | | | | | | | | | | | | | | | | | | | | | | | | | | | | | | | | | | | | | | | | | | | | | |
| VE1170A0 | D16 OPAQUE NICKEL ELLIPTICAL SUPPORT | 1 | PZ | | | | | | | | | | | | | | | | | | | | | | | | | | | | | | | | | | | | | | | | | | | | | | | |
| VE1562A0 | UNIPOLAR NA PUSH BUTTO | 1 | PZ | | | | | | | | | | | | | | | | | | | | | | | | | | | | | | | | | | | | | | | | | | | | | | | |
| VM1761A0 | D16 BLACK ELLIPTICAL SUPPORT | 1 | PZ | | | | | | | | | | | | | | | | | | | | | | | | | | | | | | | | | | | | | | | | | | | | | | | |
| VM1775A0 | OPAQUE SILVER KEY WITH GOLD "CLOUD" | 1 | PZ | | | | | | | | | | | | | | | | | | | | | | | | | | | | | | | | | | | | | | | | | | | | | | | |

| COMPONENT | | | SPARE PART | | | | | | | | | | | | | | | | | | | | | | | | | | | | | | | | | | | | | | | | | | | | | | | | | | | | | | | | | | | | | | |
|-----------|---------------------------------|---|---|--|---|------|-------------|-----|-----|----------|-------------------------------|---|----|------|-------------|-----|-----|----------|----------------|---|----|----------|------------------------------|---|----|----------|--------------------|---|----|----------|-------------------------------|---|----|------|-------------|-----|-----|----------|----------------|---|----|----------|------------------------------|---|----|----------|--------------------|---|----|----------|---------------------------------|---|----|------|-------------|-----|-----|----------|----------------|---|----|----------|------------------------------|---|----|
| Code | Description | Image | Code | Description | Components list | | | | | | | | | | | | | | | | | | | | | | | | | | | | | | | | | | | | | | | | | | | | | | | | | | | | | | | | | | | | |
| VM2009A | ELLIPTICAL SILVER SUPPORT D16 |  | KVM2009A | D16 SILVER ELLIPTICAL SUPPORT KIT | <table border="1"> <thead> <tr> <th>Code</th> <th>Description</th> <th>Qty</th> <th>UOM</th> </tr> </thead> <tbody> <tr> <td>VM2009A0</td> <td>ELLIPTICAL SILVER SUPPORT D16</td> <td>1</td> <td>PZ</td> </tr> </tbody> </table> | Code | Description | Qty | UOM | VM2009A0 | ELLIPTICAL SILVER SUPPORT D16 | 1 | PZ | | | | | | | | | | | | | | | | | | | | | | | | | | | | | | | | | | | | | | | | | | | | | | | | | | | | |
| Code | Description | Qty | UOM | | | | | | | | | | | | | | | | | | | | | | | | | | | | | | | | | | | | | | | | | | | | | | | | | | | | | | | | | | | | | | |
| VM2009A0 | ELLIPTICAL SILVER SUPPORT D16 | 1 | PZ | | | | | | | | | | | | | | | | | | | | | | | | | | | | | | | | | | | | | | | | | | | | | | | | | | | | | | | | | | | | | | |
| VM1762A | INNER LAMP SUPPORT |  | KVM1762A | LAMP INTERNAL SUPPORT KIT | <table border="1"> <thead> <tr> <th>Code</th> <th>Description</th> <th>Qty</th> <th>UOM</th> </tr> </thead> <tbody> <tr> <td>VM1762A0</td> <td>INNER LAMP SUPPORT</td> <td>1</td> <td>PZ</td> </tr> </tbody> </table> | Code | Description | Qty | UOM | VM1762A0 | INNER LAMP SUPPORT | 1 | PZ | | | | | | | | | | | | | | | | | | | | | | | | | | | | | | | | | | | | | | | | | | | | | | | | | | | | |
| Code | Description | Qty | UOM | | | | | | | | | | | | | | | | | | | | | | | | | | | | | | | | | | | | | | | | | | | | | | | | | | | | | | | | | | | | | | |
| VM1762A0 | INNER LAMP SUPPORT | 1 | PZ | | | | | | | | | | | | | | | | | | | | | | | | | | | | | | | | | | | | | | | | | | | | | | | | | | | | | | | | | | | | | | |
| VE1535A | 230V WHITE LED |  | <p>KVE1535A</p> <p>KVE0105A</p> <p>KVE0104A</p> <p>KVE0102A</p> | <p>LED LIGHT 1 PC. KIT</p> <p>CLOUD LED LIGHT+COVER+SUPPORT KIT</p> <p>NEUTRAL GREEN LIGHT KIT</p> <p>GOLDEN FLAME LIGHT COVER KIT</p> | <table border="1"> <thead> <tr> <th>Code</th> <th>Description</th> <th>Qty</th> <th>UOM</th> </tr> </thead> <tbody> <tr> <td>VE1535A1</td> <td>230V WHITE LED</td> <td>1</td> <td>PZ</td> </tr> </tbody> </table> <table border="1"> <thead> <tr> <th>Code</th> <th>Description</th> <th>Qty</th> <th>UOM</th> </tr> </thead> <tbody> <tr> <td>VE1535A1</td> <td>230V WHITE LED</td> <td>1</td> <td>PZ</td> </tr> <tr> <td>VM1761A0</td> <td>D16 BLACK ELLIPTICAL SUPPORT</td> <td>1</td> <td>PZ</td> </tr> <tr> <td>VM1762A0</td> <td>INNER LAMP SUPPORT</td> <td>1</td> <td>PZ</td> </tr> <tr> <td>VM1903A0</td> <td>GREEN PILOT WITH GOLD "CLOUD"</td> <td>1</td> <td>PZ</td> </tr> </tbody> </table> <table border="1"> <thead> <tr> <th>Code</th> <th>Description</th> <th>Qty</th> <th>UOM</th> </tr> </thead> <tbody> <tr> <td>VE1535A1</td> <td>230V WHITE LED</td> <td>1</td> <td>PZ</td> </tr> <tr> <td>VM1761A0</td> <td>D16 BLACK ELLIPTICAL SUPPORT</td> <td>1</td> <td>PZ</td> </tr> <tr> <td>VM1762A0</td> <td>INNER LAMP SUPPORT</td> <td>1</td> <td>PZ</td> </tr> <tr> <td>VM1902A0</td> <td>NEUTRAL GREEN PLASTIC COVER FOR</td> <td>1</td> <td>PZ</td> </tr> </tbody> </table> <table border="1"> <thead> <tr> <th>Code</th> <th>Description</th> <th>Qty</th> <th>UOM</th> </tr> </thead> <tbody> <tr> <td>VE1535A1</td> <td>230V WHITE LED</td> <td>1</td> <td>PZ</td> </tr> <tr> <td>VM1761A0</td> <td>D16 BLACK ELLIPTICAL SUPPORT</td> <td>1</td> <td>PZ</td> </tr> </tbody> </table> | Code | Description | Qty | UOM | VE1535A1 | 230V WHITE LED | 1 | PZ | Code | Description | Qty | UOM | VE1535A1 | 230V WHITE LED | 1 | PZ | VM1761A0 | D16 BLACK ELLIPTICAL SUPPORT | 1 | PZ | VM1762A0 | INNER LAMP SUPPORT | 1 | PZ | VM1903A0 | GREEN PILOT WITH GOLD "CLOUD" | 1 | PZ | Code | Description | Qty | UOM | VE1535A1 | 230V WHITE LED | 1 | PZ | VM1761A0 | D16 BLACK ELLIPTICAL SUPPORT | 1 | PZ | VM1762A0 | INNER LAMP SUPPORT | 1 | PZ | VM1902A0 | NEUTRAL GREEN PLASTIC COVER FOR | 1 | PZ | Code | Description | Qty | UOM | VE1535A1 | 230V WHITE LED | 1 | PZ | VM1761A0 | D16 BLACK ELLIPTICAL SUPPORT | 1 | PZ |
| Code | Description | Qty | UOM | | | | | | | | | | | | | | | | | | | | | | | | | | | | | | | | | | | | | | | | | | | | | | | | | | | | | | | | | | | | | | |
| VE1535A1 | 230V WHITE LED | 1 | PZ | | | | | | | | | | | | | | | | | | | | | | | | | | | | | | | | | | | | | | | | | | | | | | | | | | | | | | | | | | | | | | |
| Code | Description | Qty | UOM | | | | | | | | | | | | | | | | | | | | | | | | | | | | | | | | | | | | | | | | | | | | | | | | | | | | | | | | | | | | | | |
| VE1535A1 | 230V WHITE LED | 1 | PZ | | | | | | | | | | | | | | | | | | | | | | | | | | | | | | | | | | | | | | | | | | | | | | | | | | | | | | | | | | | | | | |
| VM1761A0 | D16 BLACK ELLIPTICAL SUPPORT | 1 | PZ | | | | | | | | | | | | | | | | | | | | | | | | | | | | | | | | | | | | | | | | | | | | | | | | | | | | | | | | | | | | | | |
| VM1762A0 | INNER LAMP SUPPORT | 1 | PZ | | | | | | | | | | | | | | | | | | | | | | | | | | | | | | | | | | | | | | | | | | | | | | | | | | | | | | | | | | | | | | |
| VM1903A0 | GREEN PILOT WITH GOLD "CLOUD" | 1 | PZ | | | | | | | | | | | | | | | | | | | | | | | | | | | | | | | | | | | | | | | | | | | | | | | | | | | | | | | | | | | | | | |
| Code | Description | Qty | UOM | | | | | | | | | | | | | | | | | | | | | | | | | | | | | | | | | | | | | | | | | | | | | | | | | | | | | | | | | | | | | | |
| VE1535A1 | 230V WHITE LED | 1 | PZ | | | | | | | | | | | | | | | | | | | | | | | | | | | | | | | | | | | | | | | | | | | | | | | | | | | | | | | | | | | | | | |
| VM1761A0 | D16 BLACK ELLIPTICAL SUPPORT | 1 | PZ | | | | | | | | | | | | | | | | | | | | | | | | | | | | | | | | | | | | | | | | | | | | | | | | | | | | | | | | | | | | | | |
| VM1762A0 | INNER LAMP SUPPORT | 1 | PZ | | | | | | | | | | | | | | | | | | | | | | | | | | | | | | | | | | | | | | | | | | | | | | | | | | | | | | | | | | | | | | |
| VM1902A0 | NEUTRAL GREEN PLASTIC COVER FOR | 1 | PZ | | | | | | | | | | | | | | | | | | | | | | | | | | | | | | | | | | | | | | | | | | | | | | | | | | | | | | | | | | | | | | |
| Code | Description | Qty | UOM | | | | | | | | | | | | | | | | | | | | | | | | | | | | | | | | | | | | | | | | | | | | | | | | | | | | | | | | | | | | | | |
| VE1535A1 | 230V WHITE LED | 1 | PZ | | | | | | | | | | | | | | | | | | | | | | | | | | | | | | | | | | | | | | | | | | | | | | | | | | | | | | | | | | | | | | |
| VM1761A0 | D16 BLACK ELLIPTICAL SUPPORT | 1 | PZ | | | | | | | | | | | | | | | | | | | | | | | | | | | | | | | | | | | | | | | | | | | | | | | | | | | | | | | | | | | | | | |





| COMPONENT | | | SPARE PART | | | | | | | | | | | | | | | | | | | | | | | | | | | | | | | | | | | | | | |
|-----------|------------------------------------|---|------------|------------------------------------|---|------|-------------|------------------------------------|-----|----------|-----------------------------|------------------------------|----|----------|---------------------------------|------------------------------|----|----------|------------------------------------|---------------------------------|----|----------|----------------|---|----|----------|----------------------|---|----|----------|------------------------------|---|----|----------|--------------------|---|----|----------|----------------------------|---|----|
| Code | Description | Image | Code | Description | Components list | | | | | | | | | | | | | | | | | | | | | | | | | | | | | | | | | | | | |
| VE1535A | 230V WHITE LED |  | KVE0102A | GOLDEN FLAME LIGHT COVER KIT | <table border="1"> <thead> <tr> <th>Code</th> <th>Description</th> <th>Qty</th> <th>UOM</th> </tr> </thead> <tbody> <tr> <td>VM1782A0</td> <td>INNER LAMP SUPPORT</td> <td>1</td> <td>PZ</td> </tr> <tr> <td>VM1767A0</td> <td>GREEN PILOT LIGHT W/ GOLD FLAME</td> <td>1</td> <td>PZ</td> </tr> </tbody> </table> | Code | Description | Qty | UOM | VM1782A0 | INNER LAMP SUPPORT | 1 | PZ | VM1767A0 | GREEN PILOT LIGHT W/ GOLD FLAME | 1 | PZ | | | | | | | | | | | | | | | | | | | | | | | | |
| | | | Code | Description | Qty | UOM | | | | | | | | | | | | | | | | | | | | | | | | | | | | | | | | | | | |
| | | | VM1782A0 | INNER LAMP SUPPORT | 1 | PZ | | | | | | | | | | | | | | | | | | | | | | | | | | | | | | | | | | | |
| VM1767A0 | GREEN PILOT LIGHT W/ GOLD FLAME | 1 | PZ | | | | | | | | | | | | | | | | | | | | | | | | | | | | | | | | | | | | | | |
| KVE0101A | SINUSOID LIGHT GREEN COVER KIT | <table border="1"> <thead> <tr> <th>Code</th> <th>Description</th> <th>Qty</th> <th>UOM</th> </tr> </thead> <tbody> <tr> <td>VE1535A1</td> <td>230V WHITE LED</td> <td>1</td> <td>PZ</td> </tr> <tr> <td>VM1761A0</td> <td>D16 BLACK ELLIPTICAL SUPPORT</td> <td>1</td> <td>PZ</td> </tr> <tr> <td>VM1762A0</td> <td>INNER LAMP SUPPORT</td> <td>1</td> <td>PZ</td> </tr> <tr> <td>VM1765A0</td> <td>GREEN PILOT WITH GOLD SINUSOIDE</td> <td>1</td> <td>PZ</td> </tr> </tbody> </table> | Code | Description | Qty | UOM | VE1535A1 | 230V WHITE LED | 1 | PZ | VM1761A0 | D16 BLACK ELLIPTICAL SUPPORT | 1 | PZ | VM1762A0 | INNER LAMP SUPPORT | 1 | PZ | VM1765A0 | GREEN PILOT WITH GOLD SINUSOIDE | 1 | PZ | | | | | | | | | | | | | | | | | | | |
| Code | Description | Qty | UOM | | | | | | | | | | | | | | | | | | | | | | | | | | | | | | | | | | | | | | |
| VE1535A1 | 230V WHITE LED | 1 | PZ | | | | | | | | | | | | | | | | | | | | | | | | | | | | | | | | | | | | | | |
| VM1761A0 | D16 BLACK ELLIPTICAL SUPPORT | 1 | PZ | | | | | | | | | | | | | | | | | | | | | | | | | | | | | | | | | | | | | | |
| VM1762A0 | INNER LAMP SUPPORT | 1 | PZ | | | | | | | | | | | | | | | | | | | | | | | | | | | | | | | | | | | | | | |
| VM1765A0 | GREEN PILOT WITH GOLD SINUSOIDE | 1 | PZ | | | | | | | | | | | | | | | | | | | | | | | | | | | | | | | | | | | | | | |
| KVE0100A | THERMOMETER LIGHT COVER KIT | <table border="1"> <thead> <tr> <th>Code</th> <th>Description</th> <th>Qty</th> <th>UOM</th> </tr> </thead> <tbody> <tr> <td>VE1530A0</td> <td>GOLD THERMOMETE R BLUE LIGHT COVER</td> <td>1</td> <td>PZ</td> </tr> <tr> <td>VE1535A1</td> <td>230V WHITE LED</td> <td>1</td> <td>PZ</td> </tr> <tr> <td>VM1761A0</td> <td>D16 BLACK ELLIPTICAL SUPPORT</td> <td>1</td> <td>PZ</td> </tr> <tr> <td>VM1762A0</td> <td>INNER LAMP SUPPORT</td> <td>1</td> <td>PZ</td> </tr> </tbody> </table> | Code | Description | Qty | UOM | VE1530A0 | GOLD THERMOMETE R BLUE LIGHT COVER | 1 | PZ | VE1535A1 | 230V WHITE LED | 1 | PZ | VM1761A0 | D16 BLACK ELLIPTICAL SUPPORT | 1 | PZ | VM1762A0 | INNER LAMP SUPPORT | 1 | PZ | | | | | | | | | | | | | | | | | | | |
| Code | Description | Qty | UOM | | | | | | | | | | | | | | | | | | | | | | | | | | | | | | | | | | | | | | |
| VE1530A0 | GOLD THERMOMETE R BLUE LIGHT COVER | 1 | PZ | | | | | | | | | | | | | | | | | | | | | | | | | | | | | | | | | | | | | | |
| VE1535A1 | 230V WHITE LED | 1 | PZ | | | | | | | | | | | | | | | | | | | | | | | | | | | | | | | | | | | | | | |
| VM1761A0 | D16 BLACK ELLIPTICAL SUPPORT | 1 | PZ | | | | | | | | | | | | | | | | | | | | | | | | | | | | | | | | | | | | | | |
| VM1762A0 | INNER LAMP SUPPORT | 1 | PZ | | | | | | | | | | | | | | | | | | | | | | | | | | | | | | | | | | | | | | |
| VE1535A | 230V WHITE LED |  | KVE0011A | SP KNOBS AND LIGHTS KIT | <table border="1"> <thead> <tr> <th>Code</th> <th>Description</th> <th>Qty</th> <th>UOM</th> </tr> </thead> <tbody> <tr> <td>MN1105A0</td> <td>120-400C XP THERMOSTAT KNOB</td> <td>1</td> <td>PZ</td> </tr> <tr> <td>MN1110A0</td> <td>XP NEUTRAL INDEX DIAL</td> <td>1</td> <td>PZ</td> </tr> <tr> <td>VE1530A0</td> <td>GOLD THERMOMETE R BLUE LIGHT COVER</td> <td>1</td> <td>PZ</td> </tr> <tr> <td>VE1535A1</td> <td>230V WHITE LED</td> <td>1</td> <td>PZ</td> </tr> <tr> <td>VE1561A0</td> <td>NA/NA BIPOLAR SWITCH</td> <td>1</td> <td>PZ</td> </tr> <tr> <td>VM1761A0</td> <td>D16 BLACK ELLIPTICAL SUPPORT</td> <td>2</td> <td>PZ</td> </tr> <tr> <td>VM1762A0</td> <td>INNER LAMP SUPPORT</td> <td>1</td> <td>PZ</td> </tr> <tr> <td>VM1776A0</td> <td>GOLD "0-1" MATT SILVER KEY</td> <td>1</td> <td>PZ</td> </tr> </tbody> </table> | Code | Description | Qty | UOM | MN1105A0 | 120-400C XP THERMOSTAT KNOB | 1 | PZ | MN1110A0 | XP NEUTRAL INDEX DIAL | 1 | PZ | VE1530A0 | GOLD THERMOMETE R BLUE LIGHT COVER | 1 | PZ | VE1535A1 | 230V WHITE LED | 1 | PZ | VE1561A0 | NA/NA BIPOLAR SWITCH | 1 | PZ | VM1761A0 | D16 BLACK ELLIPTICAL SUPPORT | 2 | PZ | VM1762A0 | INNER LAMP SUPPORT | 1 | PZ | VM1776A0 | GOLD "0-1" MATT SILVER KEY | 1 | PZ |
| | | | Code | Description | Qty | UOM | | | | | | | | | | | | | | | | | | | | | | | | | | | | | | | | | | | |
| | | | MN1105A0 | 120-400C XP THERMOSTAT KNOB | 1 | PZ | | | | | | | | | | | | | | | | | | | | | | | | | | | | | | | | | | | |
| | | | MN1110A0 | XP NEUTRAL INDEX DIAL | 1 | PZ | | | | | | | | | | | | | | | | | | | | | | | | | | | | | | | | | | | |
| | | | VE1530A0 | GOLD THERMOMETE R BLUE LIGHT COVER | 1 | PZ | | | | | | | | | | | | | | | | | | | | | | | | | | | | | | | | | | | |
| | | | VE1535A1 | 230V WHITE LED | 1 | PZ | | | | | | | | | | | | | | | | | | | | | | | | | | | | | | | | | | | |
| | | | VE1561A0 | NA/NA BIPOLAR SWITCH | 1 | PZ | | | | | | | | | | | | | | | | | | | | | | | | | | | | | | | | | | | |
| | | | VM1761A0 | D16 BLACK ELLIPTICAL SUPPORT | 2 | PZ | | | | | | | | | | | | | | | | | | | | | | | | | | | | | | | | | | | |
| | | | VM1762A0 | INNER LAMP SUPPORT | 1 | PZ | | | | | | | | | | | | | | | | | | | | | | | | | | | | | | | | | | | |
| | | | VM1776A0 | GOLD "0-1" MATT SILVER KEY | 1 | PZ | | | | | | | | | | | | | | | | | | | | | | | | | | | | | | | | | | | |

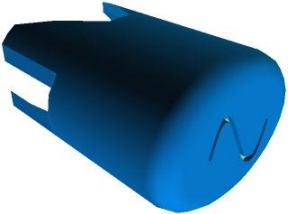

| COMPONENT | | | SPARE PART | | | | | | | | | | | | | | | | | | | | | | | | | | | | | | | | | | | | | | | | | | | | | | | |
|-----------|-------------------------------------|--|------------|--------------------------|--|------|-------------|------------------------------------|-----|----------|------------------------------------|----------------|----|----------|----------------|------------------------|----|----------|----------------------|--------------------------------|----|----------|------------------------|------------------------------|----|----------|------------------------------|--------------------|----|----------|--------------------|---------------------------------|----|----------|-------------------------------------|---------------------------------|----|----------|----------------------------|-------------------------------------|----|----|----------|---------------------------------|---|----|----------|-------------------------------|---|----|
| Code | Description | Image | Code | Description | Components list | | | | | | | | | | | | | | | | | | | | | | | | | | | | | | | | | | | | | | | | | | | | | |
| VE1535A | 230V WHITE LED |  | KVE0008A | XL PILOT BLUE LIGHTS KIT | <table border="1"> <thead> <tr> <th>Code</th> <th>Description</th> <th>Qty</th> <th>UOM</th> </tr> </thead> <tbody> <tr> <td>VE1530A0</td> <td>GOLD THERMOMETE R BLUE LIGHT COVER</td> <td>1</td> <td>PZ</td> </tr> <tr> <td>VE1535A1</td> <td>230V WHITE LED</td> <td>1</td> <td>PZ</td> </tr> <tr> <td>VE1561A0</td> <td>NA/NA BIPOLAR SWITCH</td> <td>1</td> <td>PZ</td> </tr> <tr> <td>VE1562A0</td> <td>UNIPOLAR NA PUSH BUTTO</td> <td>1</td> <td>PZ</td> </tr> <tr> <td>VM1761A0</td> <td>D16 BLACK ELLIPTICAL SUPPORT</td> <td>3</td> <td>PZ</td> </tr> <tr> <td>VM1762A0</td> <td>INNER LAMP SUPPORT</td> <td>1</td> <td>PZ</td> </tr> <tr> <td>VM1775A0</td> <td>OPAQUE SILVER KEY WITH GOLD "CLOUD"</td> <td>1</td> <td>PZ</td> </tr> <tr> <td>VM1776A0</td> <td>GOLD "0-1" MATT SILVER KEY</td> <td>1</td> <td>PZ</td> </tr> </tbody> </table> | Code | Description | Qty | UOM | VE1530A0 | GOLD THERMOMETE R BLUE LIGHT COVER | 1 | PZ | VE1535A1 | 230V WHITE LED | 1 | PZ | VE1561A0 | NA/NA BIPOLAR SWITCH | 1 | PZ | VE1562A0 | UNIPOLAR NA PUSH BUTTO | 1 | PZ | VM1761A0 | D16 BLACK ELLIPTICAL SUPPORT | 3 | PZ | VM1762A0 | INNER LAMP SUPPORT | 1 | PZ | VM1775A0 | OPAQUE SILVER KEY WITH GOLD "CLOUD" | 1 | PZ | VM1776A0 | GOLD "0-1" MATT SILVER KEY | 1 | PZ | | | | | | | | | |
| | | | Code | Description | Qty | UOM | | | | | | | | | | | | | | | | | | | | | | | | | | | | | | | | | | | | | | | | | | | | |
| VE1530A0 | GOLD THERMOMETE R BLUE LIGHT COVER | 1 | PZ | | | | | | | | | | | | | | | | | | | | | | | | | | | | | | | | | | | | | | | | | | | | | | | |
| VE1535A1 | 230V WHITE LED | 1 | PZ | | | | | | | | | | | | | | | | | | | | | | | | | | | | | | | | | | | | | | | | | | | | | | | |
| VE1561A0 | NA/NA BIPOLAR SWITCH | 1 | PZ | | | | | | | | | | | | | | | | | | | | | | | | | | | | | | | | | | | | | | | | | | | | | | | |
| VE1562A0 | UNIPOLAR NA PUSH BUTTO | 1 | PZ | | | | | | | | | | | | | | | | | | | | | | | | | | | | | | | | | | | | | | | | | | | | | | | |
| VM1761A0 | D16 BLACK ELLIPTICAL SUPPORT | 3 | PZ | | | | | | | | | | | | | | | | | | | | | | | | | | | | | | | | | | | | | | | | | | | | | | | |
| VM1762A0 | INNER LAMP SUPPORT | 1 | PZ | | | | | | | | | | | | | | | | | | | | | | | | | | | | | | | | | | | | | | | | | | | | | | | |
| VM1775A0 | OPAQUE SILVER KEY WITH GOLD "CLOUD" | 1 | PZ | | | | | | | | | | | | | | | | | | | | | | | | | | | | | | | | | | | | | | | | | | | | | | | |
| VM1776A0 | GOLD "0-1" MATT SILVER KEY | 1 | PZ | | | | | | | | | | | | | | | | | | | | | | | | | | | | | | | | | | | | | | | | | | | | | | | |
| KVE0007A | XF-XG LED AND LED COVERS KIT | <table border="1"> <thead> <tr> <th>Code</th> <th>Description</th> <th>Qty</th> <th>UOM</th> </tr> </thead> <tbody> <tr> <td>VE1530A0</td> <td>GOLD THERMOMETE R BLUE LIGHT COVER</td> <td>1</td> <td>PZ</td> </tr> <tr> <td>VE1535A1</td> <td>230V WHITE LED</td> <td>1</td> <td>PZ</td> </tr> <tr> <td>VE1562A0</td> <td>UNIPOLAR NA PUSH BUTTO</td> <td>1</td> <td>PZ</td> </tr> <tr> <td>VE1585A0</td> <td>BLUE LIGHT COVER GOLD SINUSOID</td> <td>1</td> <td>PZ</td> </tr> <tr> <td>VM1761A0</td> <td>D16 BLACK ELLIPTICAL SUPPORT</td> <td>5</td> <td>PZ</td> </tr> <tr> <td>VM1762A0</td> <td>INNER LAMP SUPPORT</td> <td>4</td> <td>PZ</td> </tr> <tr> <td>VM1767A0</td> <td>GREEN PILOT LIGHT W/ GOLD FLAME</td> <td>1</td> <td>PZ</td> </tr> <tr> <td>VM1774A0</td> <td>SILVER OPAQUE KEY W/ GOLD FLAME</td> <td>1</td> <td>PZ</td> </tr> <tr> <td>VM1775A0</td> <td>OPAQUE SILVER KEY WITH GOLD "CLOUD"</td> <td>1</td> <td>PZ</td> </tr> <tr> <td>VM1902A0</td> <td>NEUTRAL GREEN PLASTIC COVER FOR</td> <td>1</td> <td>PZ</td> </tr> <tr> <td>VM1903A0</td> <td>GREEN PILOT WITH GOLD "CLOUD"</td> <td>1</td> <td>PZ</td> </tr> </tbody> </table> | Code | Description | Qty | UOM | VE1530A0 | GOLD THERMOMETE R BLUE LIGHT COVER | 1 | PZ | VE1535A1 | 230V WHITE LED | 1 | PZ | VE1562A0 | UNIPOLAR NA PUSH BUTTO | 1 | PZ | VE1585A0 | BLUE LIGHT COVER GOLD SINUSOID | 1 | PZ | VM1761A0 | D16 BLACK ELLIPTICAL SUPPORT | 5 | PZ | VM1762A0 | INNER LAMP SUPPORT | 4 | PZ | VM1767A0 | GREEN PILOT LIGHT W/ GOLD FLAME | 1 | PZ | VM1774A0 | SILVER OPAQUE KEY W/ GOLD FLAME | 1 | PZ | VM1775A0 | OPAQUE SILVER KEY WITH GOLD "CLOUD" | 1 | PZ | VM1902A0 | NEUTRAL GREEN PLASTIC COVER FOR | 1 | PZ | VM1903A0 | GREEN PILOT WITH GOLD "CLOUD" | 1 | PZ |
| Code | Description | Qty | UOM | | | | | | | | | | | | | | | | | | | | | | | | | | | | | | | | | | | | | | | | | | | | | | | |
| VE1530A0 | GOLD THERMOMETE R BLUE LIGHT COVER | 1 | PZ | | | | | | | | | | | | | | | | | | | | | | | | | | | | | | | | | | | | | | | | | | | | | | | |
| VE1535A1 | 230V WHITE LED | 1 | PZ | | | | | | | | | | | | | | | | | | | | | | | | | | | | | | | | | | | | | | | | | | | | | | | |
| VE1562A0 | UNIPOLAR NA PUSH BUTTO | 1 | PZ | | | | | | | | | | | | | | | | | | | | | | | | | | | | | | | | | | | | | | | | | | | | | | | |
| VE1585A0 | BLUE LIGHT COVER GOLD SINUSOID | 1 | PZ | | | | | | | | | | | | | | | | | | | | | | | | | | | | | | | | | | | | | | | | | | | | | | | |
| VM1761A0 | D16 BLACK ELLIPTICAL SUPPORT | 5 | PZ | | | | | | | | | | | | | | | | | | | | | | | | | | | | | | | | | | | | | | | | | | | | | | | |
| VM1762A0 | INNER LAMP SUPPORT | 4 | PZ | | | | | | | | | | | | | | | | | | | | | | | | | | | | | | | | | | | | | | | | | | | | | | | |
| VM1767A0 | GREEN PILOT LIGHT W/ GOLD FLAME | 1 | PZ | | | | | | | | | | | | | | | | | | | | | | | | | | | | | | | | | | | | | | | | | | | | | | | |
| VM1774A0 | SILVER OPAQUE KEY W/ GOLD FLAME | 1 | PZ | | | | | | | | | | | | | | | | | | | | | | | | | | | | | | | | | | | | | | | | | | | | | | | |
| VM1775A0 | OPAQUE SILVER KEY WITH GOLD "CLOUD" | 1 | PZ | | | | | | | | | | | | | | | | | | | | | | | | | | | | | | | | | | | | | | | | | | | | | | | |
| VM1902A0 | NEUTRAL GREEN PLASTIC COVER FOR | 1 | PZ | | | | | | | | | | | | | | | | | | | | | | | | | | | | | | | | | | | | | | | | | | | | | | | |
| VM1903A0 | GREEN PILOT WITH GOLD "CLOUD" | 1 | PZ | | | | | | | | | | | | | | | | | | | | | | | | | | | | | | | | | | | | | | | | | | | | | | | |

| COMPONENT | | | SPARE PART | | | | | | | | | | | | | | | | | | | | | | | | | | |
|-----------|--------------------------------------|---|------------|--------------------------------------|--|------|-------------|--------------------------------------|-----|----------|--------------------------------------|------------------------------------|----|----------|----------------|--------------------|----|----------|--------------------------------|----------------------------------|----|----------|--------------------|---|----|----------|-------------------------------|---|----|
| Code | Description | Image | Code | Description | Components list | | | | | | | | | | | | | | | | | | | | | | | | |
| VE1535A | 230V WHITE LED |  | KLP1014A | SINUSOID LED LIGHT+COVER+SUPPORT KIT | <table border="1"> <thead> <tr> <th>Code</th> <th>Description</th> <th>Qty</th> <th>UOM</th> </tr> </thead> <tbody> <tr> <td>VE1170A0</td> <td>D16 OPAQUE NICKEL ELLIPTICAL SUPPORT</td> <td>2</td> <td>PZ</td> </tr> <tr> <td>VE1535A1</td> <td>230V WHITE LED</td> <td>2</td> <td>PZ</td> </tr> <tr> <td>VE1585A0</td> <td>BLUE LIGHT COVER GOLD SINUSOID</td> <td>2</td> <td>PZ</td> </tr> <tr> <td>VM1782A0</td> <td>INNER LAMP SUPPORT</td> <td>2</td> <td>PZ</td> </tr> <tr> <td>VM2009A0</td> <td>ELLIPTICAL SILVER SUPPORT D16</td> <td>1</td> <td>PZ</td> </tr> </tbody> </table> | Code | Description | Qty | UOM | VE1170A0 | D16 OPAQUE NICKEL ELLIPTICAL SUPPORT | 2 | PZ | VE1535A1 | 230V WHITE LED | 2 | PZ | VE1585A0 | BLUE LIGHT COVER GOLD SINUSOID | 2 | PZ | VM1782A0 | INNER LAMP SUPPORT | 2 | PZ | VM2009A0 | ELLIPTICAL SILVER SUPPORT D16 | 1 | PZ |
| | | | Code | Description | Qty | UOM | | | | | | | | | | | | | | | | | | | | | | | |
| | | | VE1170A0 | D16 OPAQUE NICKEL ELLIPTICAL SUPPORT | 2 | PZ | | | | | | | | | | | | | | | | | | | | | | | |
| VE1535A1 | 230V WHITE LED | 2 | PZ | | | | | | | | | | | | | | | | | | | | | | | | | | |
| VE1585A0 | BLUE LIGHT COVER GOLD SINUSOID | 2 | PZ | | | | | | | | | | | | | | | | | | | | | | | | | | |
| VM1782A0 | INNER LAMP SUPPORT | 2 | PZ | | | | | | | | | | | | | | | | | | | | | | | | | | |
| VM2009A0 | ELLIPTICAL SILVER SUPPORT D16 | 1 | PZ | | | | | | | | | | | | | | | | | | | | | | | | | | |
| KLP1012A | BLUE LIGHT THERMOMETER KIT | <table border="1"> <thead> <tr> <th>Code</th> <th>Description</th> <th>Qty</th> <th>UOM</th> </tr> </thead> <tbody> <tr> <td>VE1170A0</td> <td>D16 OPAQUE NICKEL ELLIPTICAL SUPPORT</td> <td>1</td> <td>PZ</td> </tr> <tr> <td>VE1530A0</td> <td>GOLD THERMOMETE R BLUE LIGHT COVER</td> <td>1</td> <td>PZ</td> </tr> <tr> <td>VE1535A1</td> <td>230V WHITE LED</td> <td>1</td> <td>PZ</td> </tr> <tr> <td>VM1782A0</td> <td>INNER LAMP SUPPORT</td> <td>1</td> <td>PZ</td> </tr> </tbody> </table> | Code | Description | Qty | UOM | VE1170A0 | D16 OPAQUE NICKEL ELLIPTICAL SUPPORT | 1 | PZ | VE1530A0 | GOLD THERMOMETE R BLUE LIGHT COVER | 1 | PZ | VE1535A1 | 230V WHITE LED | 1 | PZ | VM1782A0 | INNER LAMP SUPPORT | 1 | PZ | | | | | | | |
| Code | Description | Qty | UOM | | | | | | | | | | | | | | | | | | | | | | | | | | |
| VE1170A0 | D16 OPAQUE NICKEL ELLIPTICAL SUPPORT | 1 | PZ | | | | | | | | | | | | | | | | | | | | | | | | | | |
| VE1530A0 | GOLD THERMOMETE R BLUE LIGHT COVER | 1 | PZ | | | | | | | | | | | | | | | | | | | | | | | | | | |
| VE1535A1 | 230V WHITE LED | 1 | PZ | | | | | | | | | | | | | | | | | | | | | | | | | | |
| VM1782A0 | INNER LAMP SUPPORT | 1 | PZ | | | | | | | | | | | | | | | | | | | | | | | | | | |
| KLP1010A | THERMOSTAT GREEN LIGHT KIT | <table border="1"> <thead> <tr> <th>Code</th> <th>Description</th> <th>Qty</th> <th>UOM</th> </tr> </thead> <tbody> <tr> <td>VE1170A0</td> <td>D16 OPAQUE NICKEL ELLIPTICAL SUPPORT</td> <td>1</td> <td>PZ</td> </tr> <tr> <td>VE1535A1</td> <td>230V WHITE LED</td> <td>1</td> <td>PZ</td> </tr> <tr> <td>VM1782A0</td> <td>INNER LAMP SUPPORT</td> <td>1</td> <td>PZ</td> </tr> <tr> <td>VM1784A0</td> <td>GREEN PILOT WITH GOLD THERMOMETE</td> <td>1</td> <td>PZ</td> </tr> </tbody> </table> | Code | Description | Qty | UOM | VE1170A0 | D16 OPAQUE NICKEL ELLIPTICAL SUPPORT | 1 | PZ | VE1535A1 | 230V WHITE LED | 1 | PZ | VM1782A0 | INNER LAMP SUPPORT | 1 | PZ | VM1784A0 | GREEN PILOT WITH GOLD THERMOMETE | 1 | PZ | | | | | | | |
| Code | Description | Qty | UOM | | | | | | | | | | | | | | | | | | | | | | | | | | |
| VE1170A0 | D16 OPAQUE NICKEL ELLIPTICAL SUPPORT | 1 | PZ | | | | | | | | | | | | | | | | | | | | | | | | | | |
| VE1535A1 | 230V WHITE LED | 1 | PZ | | | | | | | | | | | | | | | | | | | | | | | | | | |
| VM1782A0 | INNER LAMP SUPPORT | 1 | PZ | | | | | | | | | | | | | | | | | | | | | | | | | | |
| VM1784A0 | GREEN PILOT WITH GOLD THERMOMETE | 1 | PZ | | | | | | | | | | | | | | | | | | | | | | | | | | |
| VE1585A | BLUE LIGHT COVER GOLD SINUSOID |  | KLP1014A | SINUSOID LED LIGHT+COVER+SUPPORT KIT | <table border="1"> <thead> <tr> <th>Code</th> <th>Description</th> <th>Qty</th> <th>UOM</th> </tr> </thead> <tbody> <tr> <td>VE1170A0</td> <td>D16 OPAQUE NICKEL ELLIPTICAL SUPPORT</td> <td>2</td> <td>PZ</td> </tr> <tr> <td>VE1535A1</td> <td>230V WHITE LED</td> <td>2</td> <td>PZ</td> </tr> <tr> <td>VE1585A0</td> <td>BLUE LIGHT COVER GOLD SINUSOID</td> <td>2</td> <td>PZ</td> </tr> <tr> <td>VM1782A0</td> <td>INNER LAMP SUPPORT</td> <td>2</td> <td>PZ</td> </tr> <tr> <td>VM2009A0</td> <td>ELLIPTICAL SILVER SUPPORT D16</td> <td>1</td> <td>PZ</td> </tr> </tbody> </table> | Code | Description | Qty | UOM | VE1170A0 | D16 OPAQUE NICKEL ELLIPTICAL SUPPORT | 2 | PZ | VE1535A1 | 230V WHITE LED | 2 | PZ | VE1585A0 | BLUE LIGHT COVER GOLD SINUSOID | 2 | PZ | VM1782A0 | INNER LAMP SUPPORT | 2 | PZ | VM2009A0 | ELLIPTICAL SILVER SUPPORT D16 | 1 | PZ |
| | | | Code | Description | Qty | UOM | | | | | | | | | | | | | | | | | | | | | | | |
| | | | VE1170A0 | D16 OPAQUE NICKEL ELLIPTICAL SUPPORT | 2 | PZ | | | | | | | | | | | | | | | | | | | | | | | |
| | | | VE1535A1 | 230V WHITE LED | 2 | PZ | | | | | | | | | | | | | | | | | | | | | | | |
| | | | VE1585A0 | BLUE LIGHT COVER GOLD SINUSOID | 2 | PZ | | | | | | | | | | | | | | | | | | | | | | | |
| VM1782A0 | INNER LAMP SUPPORT | 2 | PZ | | | | | | | | | | | | | | | | | | | | | | | | | | |
| VM2009A0 | ELLIPTICAL SILVER SUPPORT D16 | 1 | PZ | | | | | | | | | | | | | | | | | | | | | | | | | | |

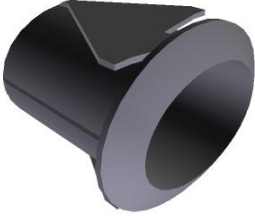

| COMPONENT | | | SPARE PART | | | | | | | | | | | | | | | | | | | | | | |
|-----------|--------------------------------------|---|------------|-----------------------------------|---|------|-------------|-----|-----|----------|--------------------------------------|---|----|----------|----------------------|---|----|----------|------------------------------|---|----|----------|----------------------------|---|----|
| Code | Description | Image | Code | Description | Components list | | | | | | | | | | | | | | | | | | | | |
| VM2009A | ELLIPTICAL SILVER SUPPORT D16 |  | KVM2009A | D16 SILVER ELLIPTICAL SUPPORT KIT | <table border="1"> <thead> <tr> <th>Code</th> <th>Description</th> <th>Qty</th> <th>UOM</th> </tr> </thead> <tbody> <tr> <td>VM2009A0</td> <td>ELLIPTICAL SILVER SUPPORT D16</td> <td>1</td> <td>PZ</td> </tr> </tbody> </table> | Code | Description | Qty | UOM | VM2009A0 | ELLIPTICAL SILVER SUPPORT D16 | 1 | PZ | | | | | | | | | | | | |
| Code | Description | Qty | UOM | | | | | | | | | | | | | | | | | | | | | | |
| VM2009A0 | ELLIPTICAL SILVER SUPPORT D16 | 1 | PZ | | | | | | | | | | | | | | | | | | | | | | |
| VM2009A | ELLIPTICAL SILVER SUPPORT D16 |  | KVM2009A | D16 SILVER ELLIPTICAL SUPPORT KIT | <table border="1"> <thead> <tr> <th>Code</th> <th>Description</th> <th>Qty</th> <th>UOM</th> </tr> </thead> <tbody> <tr> <td>VM2009A0</td> <td>ELLIPTICAL SILVER SUPPORT D16</td> <td>1</td> <td>PZ</td> </tr> </tbody> </table> | Code | Description | Qty | UOM | VM2009A0 | ELLIPTICAL SILVER SUPPORT D16 | 1 | PZ | | | | | | | | | | | | |
| Code | Description | Qty | UOM | | | | | | | | | | | | | | | | | | | | | | |
| VM2009A0 | ELLIPTICAL SILVER SUPPORT D16 | 1 | PZ | | | | | | | | | | | | | | | | | | | | | | |
| VM1776A | GOLD "0-1" MATT SILVER KEY |  | KVE0108A | XP ON-OFF SWITCH KIT | <table border="1"> <thead> <tr> <th>Code</th> <th>Description</th> <th>Qty</th> <th>UOM</th> </tr> </thead> <tbody> <tr> <td>VE1170A0</td> <td>D16 OPAQUE NICKEL ELLIPTICAL SUPPORT</td> <td>1</td> <td>PZ</td> </tr> <tr> <td>VE1561A0</td> <td>NA/NA BIPOLAR SWITCH</td> <td>1</td> <td>PZ</td> </tr> <tr> <td>VM1761A0</td> <td>D16 BLACK ELLIPTICAL SUPPORT</td> <td>1</td> <td>PZ</td> </tr> <tr> <td>VM1776A0</td> <td>GOLD "0-1" MATT SILVER KEY</td> <td>1</td> <td>PZ</td> </tr> </tbody> </table> | Code | Description | Qty | UOM | VE1170A0 | D16 OPAQUE NICKEL ELLIPTICAL SUPPORT | 1 | PZ | VE1561A0 | NA/NA BIPOLAR SWITCH | 1 | PZ | VM1761A0 | D16 BLACK ELLIPTICAL SUPPORT | 1 | PZ | VM1776A0 | GOLD "0-1" MATT SILVER KEY | 1 | PZ |
| Code | Description | Qty | UOM | | | | | | | | | | | | | | | | | | | | | | |
| VE1170A0 | D16 OPAQUE NICKEL ELLIPTICAL SUPPORT | 1 | PZ | | | | | | | | | | | | | | | | | | | | | | |
| VE1561A0 | NA/NA BIPOLAR SWITCH | 1 | PZ | | | | | | | | | | | | | | | | | | | | | | |
| VM1761A0 | D16 BLACK ELLIPTICAL SUPPORT | 1 | PZ | | | | | | | | | | | | | | | | | | | | | | |
| VM1776A0 | GOLD "0-1" MATT SILVER KEY | 1 | PZ | | | | | | | | | | | | | | | | | | | | | | |
| VE1561A | NA/NA BIPOLAR SWITCH |  | KVE0108A | XP ON-OFF SWITCH KIT | <table border="1"> <thead> <tr> <th>Code</th> <th>Description</th> <th>Qty</th> <th>UOM</th> </tr> </thead> <tbody> <tr> <td>VE1170A0</td> <td>D16 OPAQUE NICKEL ELLIPTICAL SUPPORT</td> <td>1</td> <td>PZ</td> </tr> <tr> <td>VE1561A0</td> <td>NA/NA BIPOLAR SWITCH</td> <td>1</td> <td>PZ</td> </tr> <tr> <td>VM1761A0</td> <td>D16 BLACK ELLIPTICAL SUPPORT</td> <td>1</td> <td>PZ</td> </tr> <tr> <td>VM1776A0</td> <td>GOLD "0-1" MATT SILVER KEY</td> <td>1</td> <td>PZ</td> </tr> </tbody> </table> | Code | Description | Qty | UOM | VE1170A0 | D16 OPAQUE NICKEL ELLIPTICAL SUPPORT | 1 | PZ | VE1561A0 | NA/NA BIPOLAR SWITCH | 1 | PZ | VM1761A0 | D16 BLACK ELLIPTICAL SUPPORT | 1 | PZ | VM1776A0 | GOLD "0-1" MATT SILVER KEY | 1 | PZ |
| Code | Description | Qty | UOM | | | | | | | | | | | | | | | | | | | | | | |
| VE1170A0 | D16 OPAQUE NICKEL ELLIPTICAL SUPPORT | 1 | PZ | | | | | | | | | | | | | | | | | | | | | | |
| VE1561A0 | NA/NA BIPOLAR SWITCH | 1 | PZ | | | | | | | | | | | | | | | | | | | | | | |
| VM1761A0 | D16 BLACK ELLIPTICAL SUPPORT | 1 | PZ | | | | | | | | | | | | | | | | | | | | | | |
| VM1776A0 | GOLD "0-1" MATT SILVER KEY | 1 | PZ | | | | | | | | | | | | | | | | | | | | | | |

ASM1312A/0.D02 - General overview



FRONT

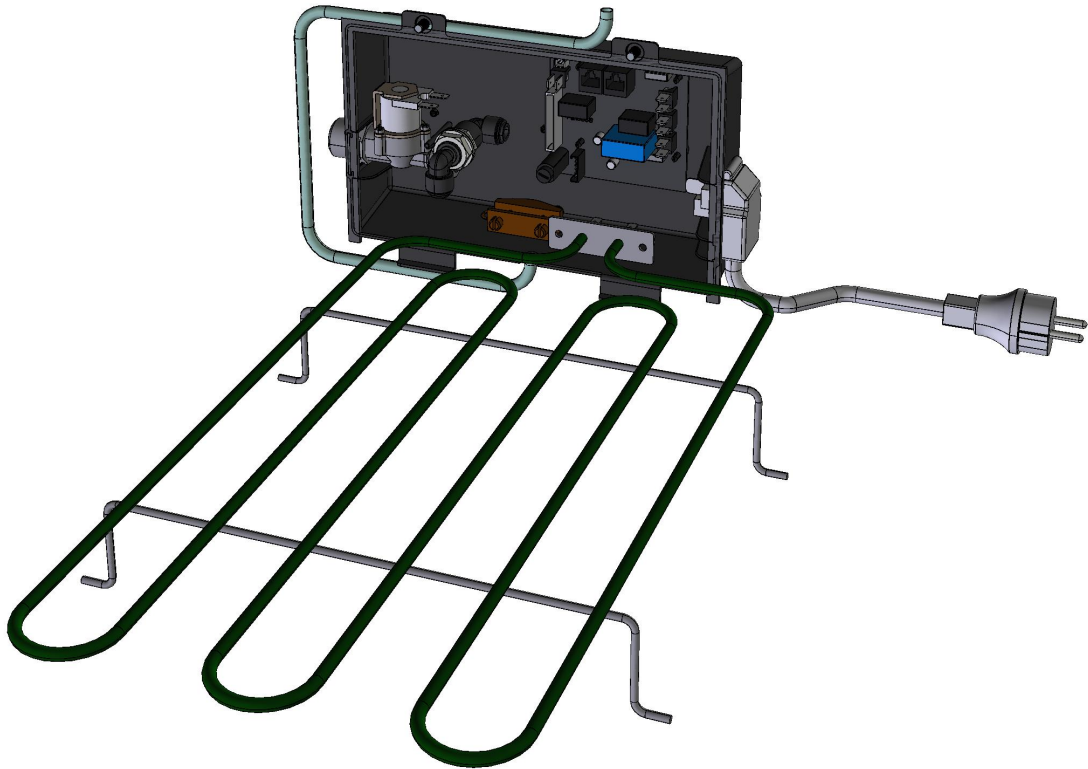



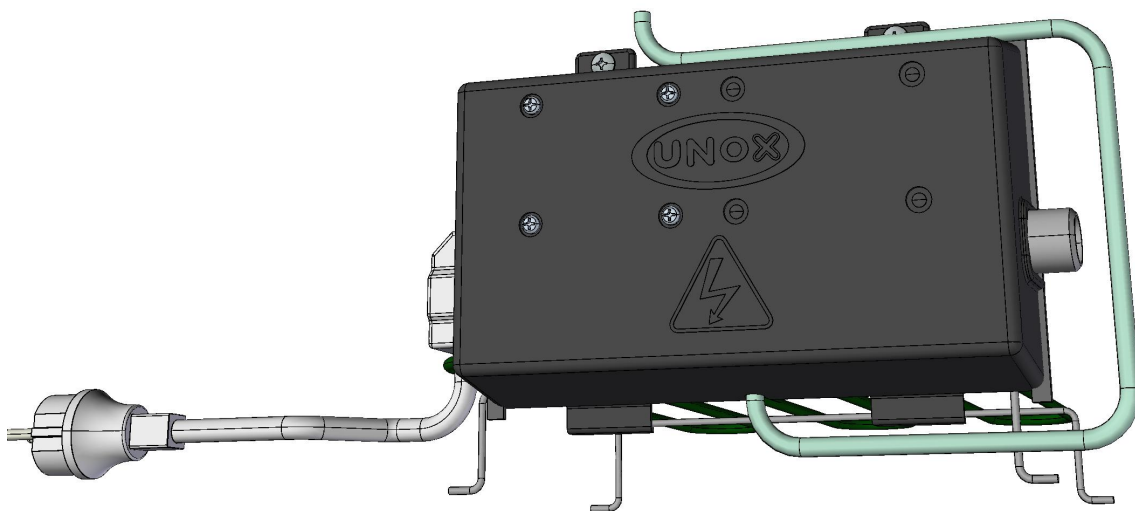

ASM1312A/0.D02 - General overview

REAR

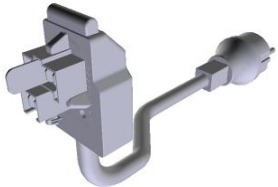
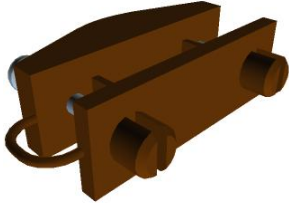
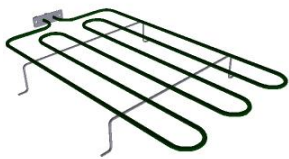

| COMPONENT | | | SPARE PART | | | | | | | | | | | | | | | | | | | | | | | | | | | | | | |
|-----------|---|---|------------|--|---|------|-------------|-----|-----|----------|---|----|----|----------|--|-------|---|----------|----------------------------------|---|----|----------|--|---|----|----------|--------------------------------------|---|----|----------|--------------------------|-------|---|
| Code | Description | Image | Code | Description | Components list | | | | | | | | | | | | | | | | | | | | | | | | | | | | |
| MR1000A | CABLE 3X1,5 H07RN-F MT1,5+K2/3+SCHUK |  | KMR1000A | KIT CABLE 3X1,5 H07RN-F +K2/3+SCHUKO | <table border="1"> <thead> <tr> <th>Code</th> <th>Description</th> <th>Qty</th> <th>UOM</th> </tr> </thead> <tbody> <tr> <td>MR1000A0</td> <td>CABLE 3X1,5 H07RN-F MT1,5+K2/3+S CHUKO</td> <td>1</td> <td>PZ</td> </tr> </tbody> </table> | Code | Description | Qty | UOM | MR1000A0 | CABLE 3X1,5 H07RN-F MT1,5+K2/3+S CHUKO | 1 | PZ | | | | | | | | | | | | | | | | | | | | |
| Code | Description | Qty | UOM | | | | | | | | | | | | | | | | | | | | | | | | | | | | | | |
| MR1000A0 | CABLE 3X1,5 H07RN-F MT1,5+K2/3+S CHUKO | 1 | PZ | | | | | | | | | | | | | | | | | | | | | | | | | | | | | | |
| VE1075A | STRAIN RELIEF PA6 UL94V2+ FIXING SCREWS |  | KVE1075A | PANEL WIRE CLAMP 10PCS KIT | <table border="1"> <thead> <tr> <th>Code</th> <th>Description</th> <th>Qty</th> <th>UOM</th> </tr> </thead> <tbody> <tr> <td>VE1075A0</td> <td>STRAIN RELIEF PA6 UL94V2+ FIXING SCREWS</td> <td>10</td> <td>PZ</td> </tr> </tbody> </table> | Code | Description | Qty | UOM | VE1075A0 | STRAIN RELIEF PA6 UL94V2+ FIXING SCREWS | 10 | PZ | | | | | | | | | | | | | | | | | | | | |
| Code | Description | Qty | UOM | | | | | | | | | | | | | | | | | | | | | | | | | | | | | | |
| VE1075A0 | STRAIN RELIEF PA6 UL94V2+ FIXING SCREWS | 10 | PZ | | | | | | | | | | | | | | | | | | | | | | | | | | | | | | |
| RS1095A | HEATING ELEMENT 1200W 230V |  | KRS1095A | 1.2KW HEATING ELEMENT KIT | <table border="1"> <thead> <tr> <th>Code</th> <th>Description</th> <th>Qty</th> <th>UOM</th> </tr> </thead> <tbody> <tr> <td>GN1326A1</td> <td>ELEMENT SEALING</td> <td>1</td> <td>PZ</td> </tr> <tr> <td>IP1385A1</td> <td>CORNER POLYSTYREN E PACKING 110X80X2000</td> <td>0.500</td> <td>M</td> </tr> <tr> <td>RS1095A1</td> <td>HEATING ELEMENT 1200W 230V</td> <td>1</td> <td>PZ</td> </tr> <tr> <td>SL1045A0</td> <td>S57 BLACK SILICONE - 80ML CARTRIDGE</td> <td>1</td> <td>PZ</td> </tr> <tr> <td>VI1220A1</td> <td>4,2X12 TCB SELF-TAPPIN G SCREW</td> <td>2</td> <td>PZ</td> </tr> <tr> <td>VM1059A1</td> <td>HEAT SHRINK FILM H800</td> <td>1.200</td> <td>M</td> </tr> </tbody> </table> | Code | Description | Qty | UOM | GN1326A1 | ELEMENT SEALING | 1 | PZ | IP1385A1 | CORNER POLYSTYREN E PACKING 110X80X2000 | 0.500 | M | RS1095A1 | HEATING ELEMENT 1200W 230V | 1 | PZ | SL1045A0 | S57 BLACK SILICONE - 80ML CARTRIDGE | 1 | PZ | VI1220A1 | 4,2X12 TCB SELF-TAPPIN G SCREW | 2 | PZ | VM1059A1 | HEAT SHRINK FILM H800 | 1.200 | M |
| Code | Description | Qty | UOM | | | | | | | | | | | | | | | | | | | | | | | | | | | | | | |
| GN1326A1 | ELEMENT SEALING | 1 | PZ | | | | | | | | | | | | | | | | | | | | | | | | | | | | | | |
| IP1385A1 | CORNER POLYSTYREN E PACKING 110X80X2000 | 0.500 | M | | | | | | | | | | | | | | | | | | | | | | | | | | | | | | |
| RS1095A1 | HEATING ELEMENT 1200W 230V | 1 | PZ | | | | | | | | | | | | | | | | | | | | | | | | | | | | | | |
| SL1045A0 | S57 BLACK SILICONE - 80ML CARTRIDGE | 1 | PZ | | | | | | | | | | | | | | | | | | | | | | | | | | | | | | |
| VI1220A1 | 4,2X12 TCB SELF-TAPPIN G SCREW | 2 | PZ | | | | | | | | | | | | | | | | | | | | | | | | | | | | | | |
| VM1059A1 | HEAT SHRINK FILM H800 | 1.200 | M | | | | | | | | | | | | | | | | | | | | | | | | | | | | | | |
| EL1140A | SINGLE WATER ELECTROVALVE W/ J.GUEST |  | KEL1140A | 1 WAY WATER SOLENOID VALVE KI | <table border="1"> <thead> <tr> <th>Code</th> <th>Description</th> <th>Qty</th> <th>UOM</th> </tr> </thead> <tbody> <tr> <td>EL1140A0</td> <td>SINGLE WATER ELECTROVAL VE W/ J.GUES</td> <td>1</td> <td>PZ</td> </tr> </tbody> </table> | Code | Description | Qty | UOM | EL1140A0 | SINGLE WATER ELECTROVAL VE W/ J.GUES | 1 | PZ | | | | | | | | | | | | | | | | | | | | |
| Code | Description | Qty | UOM | | | | | | | | | | | | | | | | | | | | | | | | | | | | | | |
| EL1140A0 | SINGLE WATER ELECTROVAL VE W/ J.GUES | 1 | PZ | | | | | | | | | | | | | | | | | | | | | | | | | | | | | | |

| COMPONENT | | | SPARE PART | | | | | | | | | | |
|-----------|---|---|------------|-------------------------------------|---|------|-------------|-----|-----|----------|-------------------------------|-------|----|
| Code | Description | Image | Code | Description | Components list | | | | | | | | |
| EL1195B | Ø8F-Ø8M ELBOW CONNECTION |  | KEL1195A | Ø8F-Ø8M JG ELBOW FITTING 10 PCS KIT | <table border="1"> <thead> <tr> <th>Code</th> <th>Description</th> <th>Qty</th> <th>UOM</th> </tr> </thead> <tbody> <tr> <td>EL1195A0</td> <td>ELBOW UNION Ø8F-Ø8M</td> <td>10</td> <td>PZ</td> </tr> </tbody> </table> | Code | Description | Qty | UOM | EL1195A0 | ELBOW UNION Ø8F-Ø8M | 10 | PZ |
| Code | Description | Qty | UOM | | | | | | | | | | |
| EL1195A0 | ELBOW UNION Ø8F-Ø8M | 10 | PZ | | | | | | | | | | |
| EL1125A | WALL PASSING SEAL Ø8 |  | KEL1125A | JG D8 THROUGH-WALL CONNECTION KIT | <table border="1"> <thead> <tr> <th>Code</th> <th>Description</th> <th>Qty</th> <th>UOM</th> </tr> </thead> <tbody> <tr> <td>EL1125A0</td> <td>WALL PASSING SEAL Ø8</td> <td>1</td> <td>PZ</td> </tr> </tbody> </table> | Code | Description | Qty | UOM | EL1125A0 | WALL PASSING SEAL Ø8 | 1 | PZ |
| Code | Description | Qty | UOM | | | | | | | | | | |
| EL1125A0 | WALL PASSING SEAL Ø8 | 1 | PZ | | | | | | | | | | |
| 0H4820A | BULB HOLDING BRACKET |  | 0H4820A1 | BULB HOLDING BRACKET | | | | | | | | | |
| CE1024A | MANUAL PROVER FRONT THERMOSTAT UL CABLE |  | CE1027A1 | UL PVC NP 4G1 WIR | | | | | | | | | |
| GN1523A | XLT COMPONENTS BOX SEAL |  | KG1328A | BLACK RUBBER SEALING PROFILE KIT | <table border="1"> <thead> <tr> <th>Code</th> <th>Description</th> <th>Qty</th> <th>UOM</th> </tr> </thead> <tbody> <tr> <td>GN1328A1</td> <td>BACK BLACK ADESIVE GASKET 8X3</td> <td>4.500</td> <td>M</td> </tr> </tbody> </table> | Code | Description | Qty | UOM | GN1328A1 | BACK BLACK ADESIVE GASKET 8X3 | 4.500 | M |
| Code | Description | Qty | UOM | | | | | | | | | | |
| GN1328A1 | BACK BLACK ADESIVE GASKET 8X3 | 4.500 | M | | | | | | | | | | |

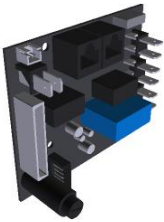

| COMPONENT | | | SPARE PART | | | | | | | | | | | | | | | | | | | | | | |
|-----------|-------------------------------------|---|------------|----------------------------|---|--------------------------------|-------------|-----|-----|----------|-------------------------------|---|----|----------|--------------------------------|---|----|----------|--------------|---|----|----------|-------------------------------------|---|----|
| Code | Description | Image | Code | Description | Components list | | | | | | | | | | | | | | | | | | | | |
| PE1065B | LINE MISS PROVER CONTROL CARD |  | KPE1065B | LINEMISS PROVER POWER CARD | <table border="1"> <thead> <tr> <th>Code</th> <th>Description</th> <th>Qty</th> <th>UOM</th> </tr> </thead> <tbody> <tr> <td>PE1065B0</td> <td>LINE MISS PROVER CONTROL CARD</td> <td>1</td> <td>PZ</td> </tr> <tr> <td>V11850A0</td> <td>M4X6 NICKEL PLATED FIXING SCRE</td> <td>4</td> <td>PZ</td> </tr> <tr> <td>VM1745A0</td> <td>CARD SUPPORT</td> <td>4</td> <td>PZ</td> </tr> <tr> <td>VM2147A0</td> <td>ESD SPONGE PINK SMOOTH 410X343X15 M</td> <td>1</td> <td>PZ</td> </tr> </tbody> </table> | Code | Description | Qty | UOM | PE1065B0 | LINE MISS PROVER CONTROL CARD | 1 | PZ | V11850A0 | M4X6 NICKEL PLATED FIXING SCRE | 4 | PZ | VM1745A0 | CARD SUPPORT | 4 | PZ | VM2147A0 | ESD SPONGE PINK SMOOTH 410X343X15 M | 1 | PZ |
| | | | | | Code | Description | Qty | UOM | | | | | | | | | | | | | | | | | |
| | | | | | PE1065B0 | LINE MISS PROVER CONTROL CARD | 1 | PZ | | | | | | | | | | | | | | | | | |
| | | | | | V11850A0 | M4X6 NICKEL PLATED FIXING SCRE | 4 | PZ | | | | | | | | | | | | | | | | | |
| | | | | | VM1745A0 | CARD SUPPORT | 4 | PZ | | | | | | | | | | | | | | | | | |
| VM2147A0 | ESD SPONGE PINK SMOOTH 410X343X15 M | 1 | PZ | | | | | | | | | | | | | | | | | | | | | | |



ASM1333A/0.D00 - General overview

FRONT

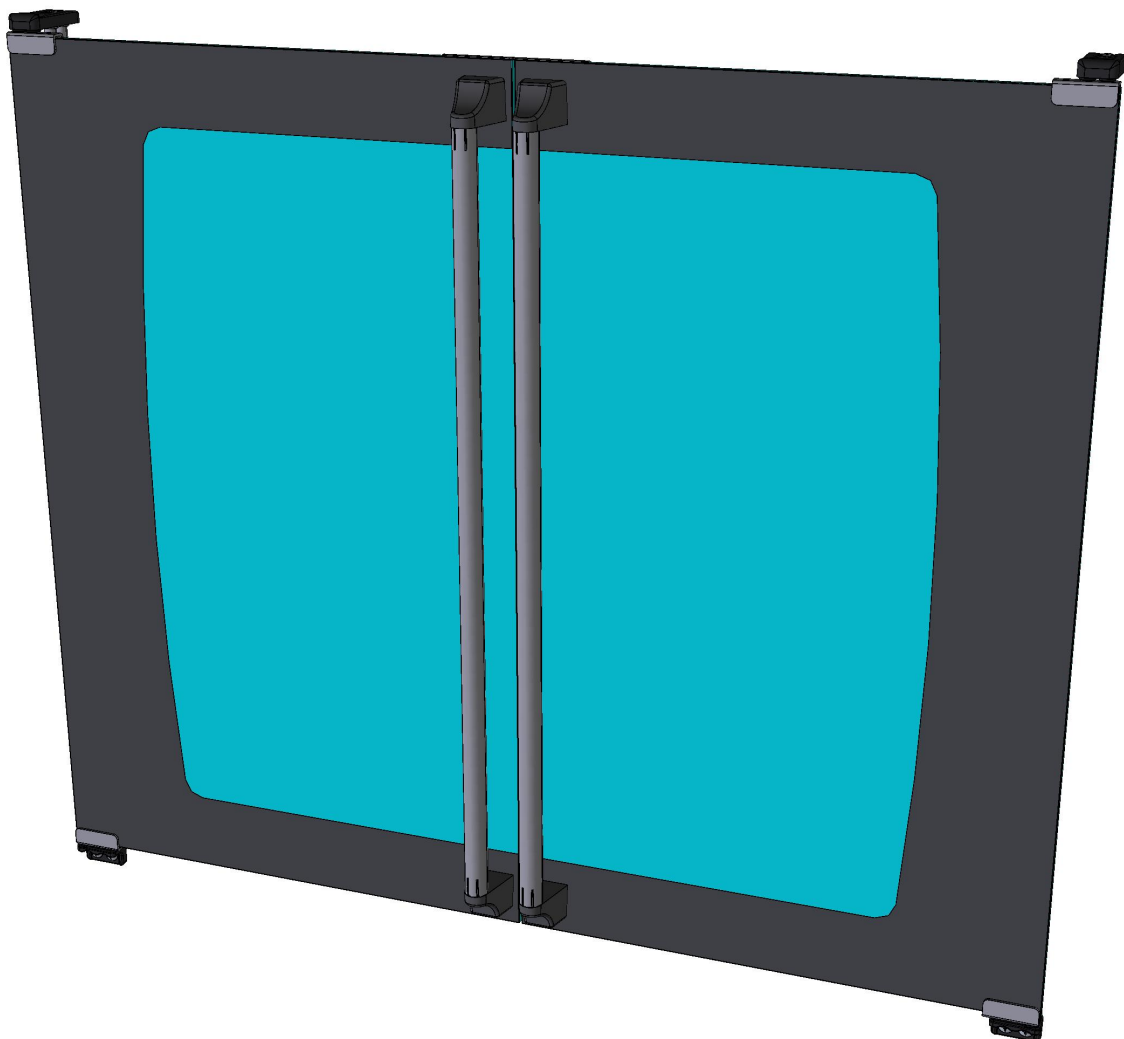



ASM1333A/0.D00 - General overview

REAR

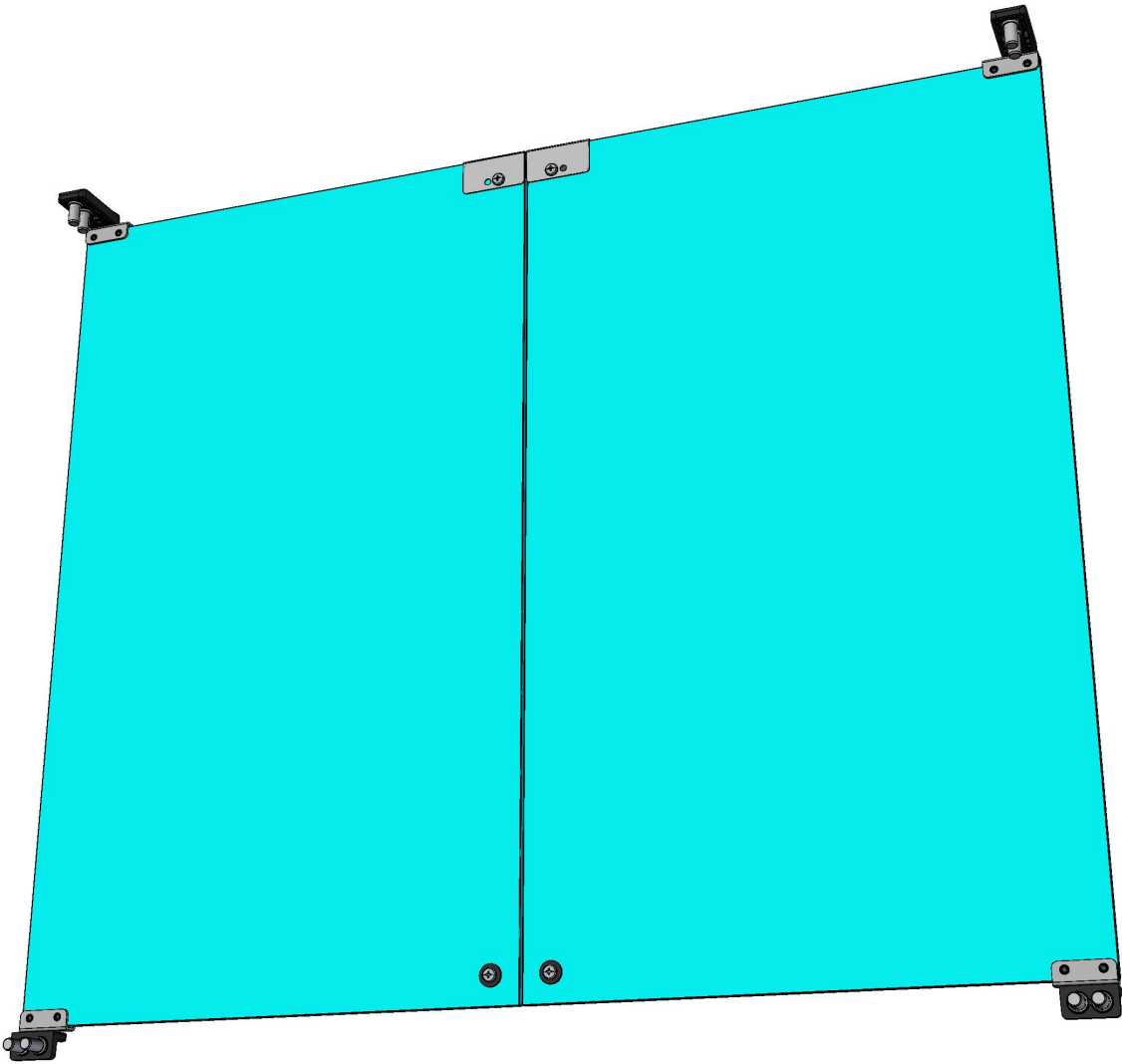



| COMPONENT | | | SPARE PART | | | | | | | | | | | | | | | | | | | | | | | | | | | | | | | | | | |
|-----------|----------------------------------|---|--------------------------|--|--|------|-------------|-----|-----|----------|----------------------------------|---|----|----------|---------------------------------|-----|-----|----------|--------------------------------|---|----|----------|-------------------------------|---|----|----------|-------------------------|---|----|----------|----------------------------|---|----|----------|-------------------------|---|----|
| Code | Description | Image | Code | Description | Components list | | | | | | | | | | | | | | | | | | | | | | | | | | | | | | | | |
| VM1022B | PROOFER DOOR UPPER BRACKET |  | KVM1022B | PROVER DOOR UPPER BRACKET | <table border="1"> <thead> <tr> <th>Code</th> <th>Description</th> <th>Qty</th> <th>UOM</th> </tr> </thead> <tbody> <tr> <td>VM1022B0</td> <td>PROOFER DOOR UPPER BRACKET</td> <td>1</td> <td>PZ</td> </tr> </tbody> </table> | Code | Description | Qty | UOM | VM1022B0 | PROOFER DOOR UPPER BRACKET | 1 | PZ | | | | | | | | | | | | | | | | | | | | | | | | |
| Code | Description | Qty | UOM | | | | | | | | | | | | | | | | | | | | | | | | | | | | | | | | | | |
| VM1022B0 | PROOFER DOOR UPPER BRACKET | 1 | PZ | | | | | | | | | | | | | | | | | | | | | | | | | | | | | | | | | | |
| VM1024B | PROOFER DOOR LEFT LOWER BRACKET |  | KVM1024B | PROVER DOOR LEFT+RIGHT LOWER BRACKET KI | <table border="1"> <thead> <tr> <th>Code</th> <th>Description</th> <th>Qty</th> <th>UOM</th> </tr> </thead> <tbody> <tr> <td>VM1023B0</td> <td>PROOFER DOOR RIGHT LOWER BRACKET</td> <td>1</td> <td>PZ</td> </tr> <tr> <td>VM1024B0</td> <td>PROOFER DOOR LEFT LOWER BRACKET</td> <td>1</td> <td>PZ</td> </tr> </tbody> </table> | Code | Description | Qty | UOM | VM1023B0 | PROOFER DOOR RIGHT LOWER BRACKET | 1 | PZ | VM1024B0 | PROOFER DOOR LEFT LOWER BRACKET | 1 | PZ | | | | | | | | | | | | | | | | | | | | |
| Code | Description | Qty | UOM | | | | | | | | | | | | | | | | | | | | | | | | | | | | | | | | | | |
| VM1023B0 | PROOFER DOOR RIGHT LOWER BRACKET | 1 | PZ | | | | | | | | | | | | | | | | | | | | | | | | | | | | | | | | | | |
| VM1024B0 | PROOFER DOOR LEFT LOWER BRACKET | 1 | PZ | | | | | | | | | | | | | | | | | | | | | | | | | | | | | | | | | | |
| CR1081A | XV-XL-XB ST. STEEL LEFT HINGE |  | KCR1080A | RIGHT/LEFT HINGES KIT CR1080A+CR1081A | <table border="1"> <thead> <tr> <th>Code</th> <th>Description</th> <th>Qty</th> <th>UOM</th> </tr> </thead> <tbody> <tr> <td>CR1080A0</td> <td>XV-XL-XB ST. STEEL RIGHT HINGE</td> <td>1</td> <td>PZ</td> </tr> <tr> <td>CR1081A0</td> <td>XV-XL-XB ST. STEEL LEFT HINGE</td> <td>1</td> <td>PZ</td> </tr> <tr> <td>GN1320A1</td> <td>DOOR GLASS GASKET</td> <td>2</td> <td>PZ</td> </tr> <tr> <td>VI1685A0</td> <td>M6X6 STAINLESS STEEL SCREW</td> <td>4</td> <td>PZ</td> </tr> <tr> <td>VM1790A0</td> <td>HINGE BUSH 12X6.5 DI5.3</td> <td>2</td> <td>PZ</td> </tr> </tbody> </table> | Code | Description | Qty | UOM | CR1080A0 | XV-XL-XB ST. STEEL RIGHT HINGE | 1 | PZ | CR1081A0 | XV-XL-XB ST. STEEL LEFT HINGE | 1 | PZ | GN1320A1 | DOOR GLASS GASKET | 2 | PZ | VI1685A0 | M6X6 STAINLESS STEEL SCREW | 4 | PZ | VM1790A0 | HINGE BUSH 12X6.5 DI5.3 | 2 | PZ | | | | | | | | |
| Code | Description | Qty | UOM | | | | | | | | | | | | | | | | | | | | | | | | | | | | | | | | | | |
| CR1080A0 | XV-XL-XB ST. STEEL RIGHT HINGE | 1 | PZ | | | | | | | | | | | | | | | | | | | | | | | | | | | | | | | | | | |
| CR1081A0 | XV-XL-XB ST. STEEL LEFT HINGE | 1 | PZ | | | | | | | | | | | | | | | | | | | | | | | | | | | | | | | | | | |
| GN1320A1 | DOOR GLASS GASKET | 2 | PZ | | | | | | | | | | | | | | | | | | | | | | | | | | | | | | | | | | |
| VI1685A0 | M6X6 STAINLESS STEEL SCREW | 4 | PZ | | | | | | | | | | | | | | | | | | | | | | | | | | | | | | | | | | |
| VM1790A0 | HINGE BUSH 12X6.5 DI5.3 | 2 | PZ | | | | | | | | | | | | | | | | | | | | | | | | | | | | | | | | | | |
| GN1320A | DOOR GLASS HINGE GASKET |  | KGN1320A KCR1080A | DOOR GLASS SEAL 4 PCS. KIT RIGHT/LEFT HINGES KIT CR1080A+CR1081A | <table border="1"> <thead> <tr> <th>Code</th> <th>Description</th> <th>Qty</th> <th>UOM</th> </tr> </thead> <tbody> <tr> <td>GN1320A1</td> <td>DOOR GLASS GASKET</td> <td>4</td> <td>PZ</td> </tr> </tbody> </table> <table border="1"> <thead> <tr> <th>Code</th> <th>Description</th> <th>Qty</th> <th>UOM</th> </tr> </thead> <tbody> <tr> <td>CR1080A0</td> <td>XV-XL-XB ST. STEEL RIGHT HINGE</td> <td>1</td> <td>PZ</td> </tr> <tr> <td>CR1081A0</td> <td>XV-XL-XB ST. STEEL LEFT HINGE</td> <td>1</td> <td>PZ</td> </tr> <tr> <td>GN1320A1</td> <td>DOOR GLASS GASKET</td> <td>2</td> <td>PZ</td> </tr> <tr> <td>VI1685A0</td> <td>M6X6 STAINLESS STEEL SCREW</td> <td>4</td> <td>PZ</td> </tr> <tr> <td>VM1790A0</td> <td>HINGE BUSH 12X6.5 DI5.3</td> <td>2</td> <td>PZ</td> </tr> </tbody> </table> | Code | Description | Qty | UOM | GN1320A1 | DOOR GLASS GASKET | 4 | PZ | Code | Description | Qty | UOM | CR1080A0 | XV-XL-XB ST. STEEL RIGHT HINGE | 1 | PZ | CR1081A0 | XV-XL-XB ST. STEEL LEFT HINGE | 1 | PZ | GN1320A1 | DOOR GLASS GASKET | 2 | PZ | VI1685A0 | M6X6 STAINLESS STEEL SCREW | 4 | PZ | VM1790A0 | HINGE BUSH 12X6.5 DI5.3 | 2 | PZ |
| Code | Description | Qty | UOM | | | | | | | | | | | | | | | | | | | | | | | | | | | | | | | | | | |
| GN1320A1 | DOOR GLASS GASKET | 4 | PZ | | | | | | | | | | | | | | | | | | | | | | | | | | | | | | | | | | |
| Code | Description | Qty | UOM | | | | | | | | | | | | | | | | | | | | | | | | | | | | | | | | | | |
| CR1080A0 | XV-XL-XB ST. STEEL RIGHT HINGE | 1 | PZ | | | | | | | | | | | | | | | | | | | | | | | | | | | | | | | | | | |
| CR1081A0 | XV-XL-XB ST. STEEL LEFT HINGE | 1 | PZ | | | | | | | | | | | | | | | | | | | | | | | | | | | | | | | | | | |
| GN1320A1 | DOOR GLASS GASKET | 2 | PZ | | | | | | | | | | | | | | | | | | | | | | | | | | | | | | | | | | |
| VI1685A0 | M6X6 STAINLESS STEEL SCREW | 4 | PZ | | | | | | | | | | | | | | | | | | | | | | | | | | | | | | | | | | |
| VM1790A0 | HINGE BUSH 12X6.5 DI5.3 | 2 | PZ | | | | | | | | | | | | | | | | | | | | | | | | | | | | | | | | | | |

| COMPONENT | | | SPARE PART | | | | | | | | | | | | | | | | | | | | | | | | | | | |
|-----------|--|--|--------------------------|--|--|---------------------------------------|---|----------|--------------------------|--|--------------------------------|-------------|-----|----------|-------------------------------|------------------------------------|----|----------|-------------------|-------------------------|----|----------|----------------------------|--|----|----------|-------------------------|--------------------|----|----|
| Code | Description | Image | Code | Description | Components list | | | | | | | | | | | | | | | | | | | | | | | | | |
| CR1080A | XV-XL-XB ST. STEEL RIGHT HINGE |  | KCR1080A | RIGHT/LEFT HINGES KIT CR1080A+CR1081A | <table border="1"> <thead> <tr> <th>Code</th> <th>Description</th> <th>Qty</th> <th>UOM</th> </tr> </thead> <tbody> <tr> <td>CR1080A0</td> <td>XV-XL-XB ST. STEEL RIGHT HINGE</td> <td>1</td> <td>PZ</td> </tr> <tr> <td>CR1081A0</td> <td>XV-XL-XB ST. STEEL LEFT HINGE</td> <td>1</td> <td>PZ</td> </tr> <tr> <td>GN1320A1</td> <td>DOOR GLASS GASKET</td> <td>2</td> <td>PZ</td> </tr> <tr> <td>VI1685A0</td> <td>M6X6 STAINLESS STEEL SCREW</td> <td>4</td> <td>PZ</td> </tr> <tr> <td>VM1790A0</td> <td>HINGE BUSH 12X6.5 DI5.3</td> <td>2</td> <td>PZ</td> </tr> </tbody> </table> | Code | Description | Qty | UOM | CR1080A0 | XV-XL-XB ST. STEEL RIGHT HINGE | 1 | PZ | CR1081A0 | XV-XL-XB ST. STEEL LEFT HINGE | 1 | PZ | GN1320A1 | DOOR GLASS GASKET | 2 | PZ | VI1685A0 | M6X6 STAINLESS STEEL SCREW | 4 | PZ | VM1790A0 | HINGE BUSH 12X6.5 DI5.3 | 2 | PZ | |
| | | | | | Code | Description | Qty | UOM | | | | | | | | | | | | | | | | | | | | | | |
| | | | | | CR1080A0 | XV-XL-XB ST. STEEL RIGHT HINGE | 1 | PZ | | | | | | | | | | | | | | | | | | | | | | |
| | | | | | CR1081A0 | XV-XL-XB ST. STEEL LEFT HINGE | 1 | PZ | | | | | | | | | | | | | | | | | | | | | | |
| | | | | | GN1320A1 | DOOR GLASS GASKET | 2 | PZ | | | | | | | | | | | | | | | | | | | | | | |
| VI1685A0 | M6X6 STAINLESS STEEL SCREW | 4 | PZ | | | | | | | | | | | | | | | | | | | | | | | | | | | |
| VM1790A0 | HINGE BUSH 12X6.5 DI5.3 | 2 | PZ | | | | | | | | | | | | | | | | | | | | | | | | | | | |
| GN1320A | DOOR GLASS HINGE GASKET |  | KGN1320A KCR1080A | DOOR GLASS SEAL 4 PCS. KIT RIGHT/LEFT HINGES KIT CR1080A+CR1081A | <table border="1"> <thead> <tr> <th>Code</th> <th>Description</th> <th>Qty</th> <th>UOM</th> </tr> </thead> <tbody> <tr> <td>GN1320A1</td> <td>DOOR GLASS GASKET</td> <td>4</td> <td>PZ</td> </tr> </tbody> </table> | Code | Description | Qty | UOM | GN1320A1 | DOOR GLASS GASKET | 4 | PZ | | | | | | | | | | | | | | | | | |
| | | | | | Code | Description | Qty | UOM | | | | | | | | | | | | | | | | | | | | | | |
| | | | | | GN1320A1 | DOOR GLASS GASKET | 4 | PZ | | | | | | | | | | | | | | | | | | | | | | |
| | | | | | MG1015B | L.MISS/L.MICRO/CH EFTOP HANDLE END |  | KMG1015B | 2 PCS. HANDLE END KIT | <table border="1"> <thead> <tr> <th>Code</th> <th>Description</th> <th>Qty</th> <th>UOM</th> </tr> </thead> <tbody> <tr> <td>MG1015B0</td> <td>L.MISS/L.MICRO/CH EFTOP HANDLE END</td> <td>2</td> <td>PZ</td> </tr> <tr> <td>VI1855A0</td> <td>5X25 SELF-TAPPING SCREW</td> <td>2</td> <td>PZ</td> </tr> <tr> <td>VI1870A0</td> <td>50X50 SELF-THREADING SCREW FOR PLASTIC</td> <td>2</td> <td>PZ</td> </tr> <tr> <td>VM1025A0</td> <td>Ø16 GREY NYLON LID</td> <td>2</td> <td>PZ</td> </tr> </tbody> </table> | Code | Description | Qty | UOM | MG1015B0 | L.MISS/L.MICRO/CH EFTOP HANDLE END | 2 | PZ | VI1855A0 | 5X25 SELF-TAPPING SCREW | 2 | PZ | VI1870A0 | 50X50 SELF-THREADING SCREW FOR PLASTIC | 2 | PZ | VM1025A0 | Ø16 GREY NYLON LID | 2 | PZ |
| | | | | | | | | | | Code | Description | Qty | UOM | | | | | | | | | | | | | | | | | |
| MG1015B0 | L.MISS/L.MICRO/CH EFTOP HANDLE END | 2 | PZ | | | | | | | | | | | | | | | | | | | | | | | | | | | |
| VI1855A0 | 5X25 SELF-TAPPING SCREW | 2 | PZ | | | | | | | | | | | | | | | | | | | | | | | | | | | |
| VI1870A0 | 50X50 SELF-THREADING SCREW FOR PLASTIC | 2 | PZ | | | | | | | | | | | | | | | | | | | | | | | | | | | |
| VM1025A0 | Ø16 GREY NYLON LID | 2 | PZ | | | | | | | | | | | | | | | | | | | | | | | | | | | |

| COMPONENT | | | SPARE PART | | | | | | | | | | | | | | | | | | | | | | | | | | | | | | | | | | | | | | |
|-----------|--|---|------------|---|---|------|-------------|-----|-----|----------|---|---|----|----------|--------------------------------------|---|----|----------|-------------------------------------|---|----|----------|----------------------|---|----|----------|----------------------------------|---|----|----------|--|---|----|----------|---|---|----|----------|----------------------------------|---|----|
| Code | Description | Image | Code | Description | Components list | | | | | | | | | | | | | | | | | | | | | | | | | | | | | | | | | | | | |
| VM1720A | XL405 DOOR WASKER |  | VM1720A0 | XL405 DOOR WASKER | | | | | | | | | | | | | | | | | | | | | | | | | | | | | | | | | | | | | |
| TB1077A | XLT135/XLT195 Ø18X1 HANDLE TUB |  | KTB1077A | XLT135/XLT195 HANDLE TUBE KIT | <table border="1"> <thead> <tr> <th>Code</th> <th>Description</th> <th>Qty</th> <th>UOM</th> </tr> </thead> <tbody> <tr> <td>TB1077A0</td> <td>XLT135/XLT195 5 Ø18X1 HANDLE TUBE</td> <td>1</td> <td>PZ</td> </tr> <tr> <td>VI1220A1</td> <td>4,2X12 TCB SELF-TAPPIN G SCREW</td> <td>4</td> <td>PZ</td> </tr> <tr> <td>VM1794A0</td> <td>250X4.8 PA66 BLACK CLAMP</td> <td>2</td> <td>PZ</td> </tr> <tr> <td>VM2103A0</td> <td>CLAMP LOCK</td> <td>2</td> <td>PZ</td> </tr> </tbody> </table> | Code | Description | Qty | UOM | TB1077A0 | XLT135/XLT195 5 Ø18X1 HANDLE TUBE | 1 | PZ | VI1220A1 | 4,2X12 TCB SELF-TAPPIN G SCREW | 4 | PZ | VM1794A0 | 250X4.8 PA66 BLACK CLAMP | 2 | PZ | VM2103A0 | CLAMP LOCK | 2 | PZ | | | | | | | | | | | | | | | | |
| Code | Description | Qty | UOM | | | | | | | | | | | | | | | | | | | | | | | | | | | | | | | | | | | | | | |
| TB1077A0 | XLT135/XLT195 5 Ø18X1 HANDLE TUBE | 1 | PZ | | | | | | | | | | | | | | | | | | | | | | | | | | | | | | | | | | | | | | |
| VI1220A1 | 4,2X12 TCB SELF-TAPPIN G SCREW | 4 | PZ | | | | | | | | | | | | | | | | | | | | | | | | | | | | | | | | | | | | | | |
| VM1794A0 | 250X4.8 PA66 BLACK CLAMP | 2 | PZ | | | | | | | | | | | | | | | | | | | | | | | | | | | | | | | | | | | | | | |
| VM2103A0 | CLAMP LOCK | 2 | PZ | | | | | | | | | | | | | | | | | | | | | | | | | | | | | | | | | | | | | | |
| 0H4540A | DOOR PLATES MAGNET XL405 |  | 0H4540A0 | DOOR PLATES MAGNET XL405 | | | | | | | | | | | | | | | | | | | | | | | | | | | | | | | | | | | | | |
| GN1330A | FERRITIC PLATE GASKET XL405 |  | KVT1086BR | XLT195/XLT193 RIGHT COMPLETE DOOR KIT | <table border="1"> <thead> <tr> <th>Code</th> <th>Description</th> <th>Qty</th> <th>UOM</th> </tr> </thead> <tbody> <tr> <td>0H4540A0</td> <td>DOOR PLATES MAGNET XL40</td> <td>1</td> <td>PZ</td> </tr> <tr> <td>CR1080A0</td> <td>XV-XL-XB ST. STEEL RIGHT HINGE</td> <td>1</td> <td>PZ</td> </tr> <tr> <td>CR1081A0</td> <td>XV-XL-XB ST. STEEL LEFT HINGE</td> <td>1</td> <td>PZ</td> </tr> <tr> <td>GN1320A1</td> <td>DOOR GLASS GASKET</td> <td>2</td> <td>PZ</td> </tr> <tr> <td>GN1330A0</td> <td>FERRITIC PLATE GASKET XL40</td> <td>1</td> <td>PZ</td> </tr> <tr> <td>MG1015B0</td> <td>L.MISS/L.MICR O/CHEFTOP HANDLE END</td> <td>2</td> <td>PZ</td> </tr> <tr> <td>TB1077A0</td> <td>XLT135/XLT195 5 Ø18X1 HANDLE TUBE</td> <td>1</td> <td>PZ</td> </tr> <tr> <td>VI1685A0</td> <td>M6X6 STAINLESS STEEL SCREW</td> <td>4</td> <td>PZ</td> </tr> </tbody> </table> | Code | Description | Qty | UOM | 0H4540A0 | DOOR PLATES MAGNET XL40 | 1 | PZ | CR1080A0 | XV-XL-XB ST. STEEL RIGHT HINGE | 1 | PZ | CR1081A0 | XV-XL-XB ST. STEEL LEFT HINGE | 1 | PZ | GN1320A1 | DOOR GLASS GASKET | 2 | PZ | GN1330A0 | FERRITIC PLATE GASKET XL40 | 1 | PZ | MG1015B0 | L.MISS/L.MICR O/CHEFTOP HANDLE END | 2 | PZ | TB1077A0 | XLT135/XLT195 5 Ø18X1 HANDLE TUBE | 1 | PZ | VI1685A0 | M6X6 STAINLESS STEEL SCREW | 4 | PZ |
| Code | Description | Qty | UOM | | | | | | | | | | | | | | | | | | | | | | | | | | | | | | | | | | | | | | |
| 0H4540A0 | DOOR PLATES MAGNET XL40 | 1 | PZ | | | | | | | | | | | | | | | | | | | | | | | | | | | | | | | | | | | | | | |
| CR1080A0 | XV-XL-XB ST. STEEL RIGHT HINGE | 1 | PZ | | | | | | | | | | | | | | | | | | | | | | | | | | | | | | | | | | | | | | |
| CR1081A0 | XV-XL-XB ST. STEEL LEFT HINGE | 1 | PZ | | | | | | | | | | | | | | | | | | | | | | | | | | | | | | | | | | | | | | |
| GN1320A1 | DOOR GLASS GASKET | 2 | PZ | | | | | | | | | | | | | | | | | | | | | | | | | | | | | | | | | | | | | | |
| GN1330A0 | FERRITIC PLATE GASKET XL40 | 1 | PZ | | | | | | | | | | | | | | | | | | | | | | | | | | | | | | | | | | | | | | |
| MG1015B0 | L.MISS/L.MICR O/CHEFTOP HANDLE END | 2 | PZ | | | | | | | | | | | | | | | | | | | | | | | | | | | | | | | | | | | | | | |
| TB1077A0 | XLT135/XLT195 5 Ø18X1 HANDLE TUBE | 1 | PZ | | | | | | | | | | | | | | | | | | | | | | | | | | | | | | | | | | | | | | |
| VI1685A0 | M6X6 STAINLESS STEEL SCREW | 4 | PZ | | | | | | | | | | | | | | | | | | | | | | | | | | | | | | | | | | | | | | |





| COMPONENT | | | SPARE PART | | | | | | | | | | | | | | | | | | | | | | | | | | | | | | | | | | | | | | | | | | | | | | | | | | | |
|-----------|--|--|------------|---|---|------|-------------|----------------------------|-----|----------|---------------------------------|--------------------------------------|----|----------|----------------------|-------------------------------------|----|----------|--|----------------------|----|----------|--|----------------------------------|----|----|----------|--|---|----|----------|--|---|----|----------|----------------------------------|---|----|----------|---------------------------------|---|----|----------|----------------------|---|----|----------|--|---|----|----------|--|---|----|
| Code | Description | Image | Code | Description | Components list | | | | | | | | | | | | | | | | | | | | | | | | | | | | | | | | | | | | | | | | | | | | | | | | | |
| GN1330A | FERRITIC PLATE GASKET XL405 |  | KVT1086BR | XLT195/XLT193 RIGHT COMPLETE DOOR KIT | <table border="1"> <thead> <tr> <th>Code</th> <th>Description</th> <th>Qty</th> <th>UOM</th> </tr> </thead> <tbody> <tr> <td>VI1930A0</td> <td>5X25 ST. STEEL SCREW CHIP</td> <td>2</td> <td>PZ</td> </tr> <tr> <td>VM1720A0</td> <td>XL405 DOOR WASKER</td> <td>1</td> <td>PZ</td> </tr> <tr> <td>VT1086B0</td> <td>XLT195/XLT19 3 DOOR BLACK GLASS 399X661</td> <td>1</td> <td>PZ</td> </tr> <tr> <td>VT1086B0</td> <td>XLT195/XLT19 3 DOOR BLACK GLASS 399X661</td> <td>1</td> <td>PZ</td> </tr> </tbody> </table> | Code | Description | Qty | UOM | VI1930A0 | 5X25 ST. STEEL SCREW CHIP | 2 | PZ | VM1720A0 | XL405 DOOR WASKER | 1 | PZ | VT1086B0 | XLT195/XLT19 3 DOOR BLACK GLASS 399X661 | 1 | PZ | VT1086B0 | XLT195/XLT19 3 DOOR BLACK GLASS 399X661 | 1 | PZ | | | | | | | | | | | | | | | | | | | | | | | | | | | | | |
| | | | Code | Description | Qty | UOM | | | | | | | | | | | | | | | | | | | | | | | | | | | | | | | | | | | | | | | | | | | | | | | | |
| VI1930A0 | 5X25 ST. STEEL SCREW CHIP | 2 | PZ | | | | | | | | | | | | | | | | | | | | | | | | | | | | | | | | | | | | | | | | | | | | | | | | | | | |
| VM1720A0 | XL405 DOOR WASKER | 1 | PZ | | | | | | | | | | | | | | | | | | | | | | | | | | | | | | | | | | | | | | | | | | | | | | | | | | | |
| VT1086B0 | XLT195/XLT19 3 DOOR BLACK GLASS 399X661 | 1 | PZ | | | | | | | | | | | | | | | | | | | | | | | | | | | | | | | | | | | | | | | | | | | | | | | | | | | |
| VT1086B0 | XLT195/XLT19 3 DOOR BLACK GLASS 399X661 | 1 | PZ | | | | | | | | | | | | | | | | | | | | | | | | | | | | | | | | | | | | | | | | | | | | | | | | | | | |
| KVT1086BL | XLT195/XLT193 LEFT COMPLETE DOOR KIT | <table border="1"> <thead> <tr> <th>Code</th> <th>Description</th> <th>Qty</th> <th>UOM</th> </tr> </thead> <tbody> <tr> <td>0H4540A0</td> <td>DOOR PLATES MAGNET XL40</td> <td>1</td> <td>PZ</td> </tr> <tr> <td>CR1080A0</td> <td>XV-XL-XB ST. STEEL RIGHT HINGE</td> <td>1</td> <td>PZ</td> </tr> <tr> <td>CR1081A0</td> <td>XV-XL-XB ST. STEEL LEFT HINGE</td> <td>1</td> <td>PZ</td> </tr> <tr> <td>GN1320A1</td> <td>DOOR GLASS GASKET</td> <td>2</td> <td>PZ</td> </tr> <tr> <td>GN1330A0</td> <td>FERRITIC PLATE GASKET XL40</td> <td>1</td> <td>PZ</td> </tr> <tr> <td>MG1015B0</td> <td>L.MISS/L.MICR O/CHEFTOP HANDLE END</td> <td>2</td> <td>PZ</td> </tr> <tr> <td>TB1077A0</td> <td>XLT135/XLT19 5 Ø18X1 HANDLE TUBE</td> <td>1</td> <td>PZ</td> </tr> <tr> <td>VI1685A0</td> <td>M6X6 STAINLESS STEEL SCREW</td> <td>4</td> <td>PZ</td> </tr> <tr> <td>VI1930A0</td> <td>5X25 ST. STEEL SCREW CHIP</td> <td>2</td> <td>PZ</td> </tr> <tr> <td>VM1720A0</td> <td>XL405 DOOR WASKER</td> <td>1</td> <td>PZ</td> </tr> <tr> <td>VT1086B0</td> <td>XLT195/XLT19 3 DOOR BLACK GLASS 399X661</td> <td>1</td> <td>PZ</td> </tr> <tr> <td>VT1086B0</td> <td>XLT195/XLT19 3 DOOR BLACK GLASS 399X661</td> <td>1</td> <td>PZ</td> </tr> </tbody> </table> | Code | Description | Qty | UOM | 0H4540A0 | DOOR PLATES MAGNET XL40 | 1 | PZ | CR1080A0 | XV-XL-XB ST. STEEL RIGHT HINGE | 1 | PZ | CR1081A0 | XV-XL-XB ST. STEEL LEFT HINGE | 1 | PZ | GN1320A1 | DOOR GLASS GASKET | 2 | PZ | GN1330A0 | FERRITIC PLATE GASKET XL40 | 1 | PZ | MG1015B0 | L.MISS/L.MICR O/CHEFTOP HANDLE END | 2 | PZ | TB1077A0 | XLT135/XLT19 5 Ø18X1 HANDLE TUBE | 1 | PZ | VI1685A0 | M6X6 STAINLESS STEEL SCREW | 4 | PZ | VI1930A0 | 5X25 ST. STEEL SCREW CHIP | 2 | PZ | VM1720A0 | XL405 DOOR WASKER | 1 | PZ | VT1086B0 | XLT195/XLT19 3 DOOR BLACK GLASS 399X661 | 1 | PZ | VT1086B0 | XLT195/XLT19 3 DOOR BLACK GLASS 399X661 | 1 | PZ |
| Code | Description | Qty | UOM | | | | | | | | | | | | | | | | | | | | | | | | | | | | | | | | | | | | | | | | | | | | | | | | | | | |
| 0H4540A0 | DOOR PLATES MAGNET XL40 | 1 | PZ | | | | | | | | | | | | | | | | | | | | | | | | | | | | | | | | | | | | | | | | | | | | | | | | | | | |
| CR1080A0 | XV-XL-XB ST. STEEL RIGHT HINGE | 1 | PZ | | | | | | | | | | | | | | | | | | | | | | | | | | | | | | | | | | | | | | | | | | | | | | | | | | | |
| CR1081A0 | XV-XL-XB ST. STEEL LEFT HINGE | 1 | PZ | | | | | | | | | | | | | | | | | | | | | | | | | | | | | | | | | | | | | | | | | | | | | | | | | | | |
| GN1320A1 | DOOR GLASS GASKET | 2 | PZ | | | | | | | | | | | | | | | | | | | | | | | | | | | | | | | | | | | | | | | | | | | | | | | | | | | |
| GN1330A0 | FERRITIC PLATE GASKET XL40 | 1 | PZ | | | | | | | | | | | | | | | | | | | | | | | | | | | | | | | | | | | | | | | | | | | | | | | | | | | |
| MG1015B0 | L.MISS/L.MICR O/CHEFTOP HANDLE END | 2 | PZ | | | | | | | | | | | | | | | | | | | | | | | | | | | | | | | | | | | | | | | | | | | | | | | | | | | |
| TB1077A0 | XLT135/XLT19 5 Ø18X1 HANDLE TUBE | 1 | PZ | | | | | | | | | | | | | | | | | | | | | | | | | | | | | | | | | | | | | | | | | | | | | | | | | | | |
| VI1685A0 | M6X6 STAINLESS STEEL SCREW | 4 | PZ | | | | | | | | | | | | | | | | | | | | | | | | | | | | | | | | | | | | | | | | | | | | | | | | | | | |
| VI1930A0 | 5X25 ST. STEEL SCREW CHIP | 2 | PZ | | | | | | | | | | | | | | | | | | | | | | | | | | | | | | | | | | | | | | | | | | | | | | | | | | | |
| VM1720A0 | XL405 DOOR WASKER | 1 | PZ | | | | | | | | | | | | | | | | | | | | | | | | | | | | | | | | | | | | | | | | | | | | | | | | | | | |
| VT1086B0 | XLT195/XLT19 3 DOOR BLACK GLASS 399X661 | 1 | PZ | | | | | | | | | | | | | | | | | | | | | | | | | | | | | | | | | | | | | | | | | | | | | | | | | | | |
| VT1086B0 | XLT195/XLT19 3 DOOR BLACK GLASS 399X661 | 1 | PZ | | | | | | | | | | | | | | | | | | | | | | | | | | | | | | | | | | | | | | | | | | | | | | | | | | | |





| COMPONENT | | | SPARE PART | | | | | | | | | | | | | | | | | | | | | | | | | | | | | | | | | | | | | | | | | | | | | | | | | | | | | | | | | | | | | | | | | | | | | | | | | | | | | | | | | | | | | |
|-----------|---|---|------------|---|---|------|-------------|-----|-----|----------|----------------------------|---|----|----------|--------------------------------------|---|----|----------|-------------------------------------|---|----|----------|----------------------|---|----|----------|----------------------------------|---|----|----------|--|-------|---|----------|---|-------|---|----------|--|---|----|----------|--|---|----|----------|----------------------------------|---|----|----------|---------------------------------|---|----|----------|--------------------------|-------|---|----------|----------------------|---|----|----------|--|---|----|----------|--|---|----|-----------|--|---|------|-------------|-----|-----|----------|----------------------------|---|----|----------|--------------------------------------|---|----|----------|-------------------------------------|---|----|
| Code | Description | Image | Code | Description | Components list | | | | | | | | | | | | | | | | | | | | | | | | | | | | | | | | | | | | | | | | | | | | | | | | | | | | | | | | | | | | | | | | | | | | | | | | | | | | | | | | | | | |
| GN1330A | FERRITIC PLATE GASKET XL405 |  | KVT1076BR | XLT135/XLT133 RIGHT COMPLETE DOOR KIT | <table border="1"> <thead> <tr> <th>Code</th> <th>Description</th> <th>Qty</th> <th>UOM</th> </tr> </thead> <tbody> <tr> <td>0H4540A0</td> <td>DOOR PLATES MAGNET XL40</td> <td>1</td> <td>PZ</td> </tr> <tr> <td>CR1080A0</td> <td>XV-XL-XB ST. STEEL RIGHT HINGE</td> <td>1</td> <td>PZ</td> </tr> <tr> <td>CR1081A0</td> <td>XV-XL-XB ST. STEEL LEFT HINGE</td> <td>1</td> <td>PZ</td> </tr> <tr> <td>GN1320A1</td> <td>DOOR GLASS GASKET</td> <td>2</td> <td>PZ</td> </tr> <tr> <td>GN1330A0</td> <td>FERRITIC PLATE GASKET XL40</td> <td>1</td> <td>PZ</td> </tr> <tr> <td>IP1385A1</td> <td>CORNER POLYSTYREN E PACKING 110X80X2000</td> <td>1.400</td> <td>M</td> </tr> <tr> <td>IP1508A1</td> <td>POLYSTYREN E U SHAPED PROFILE 2000X60X60</td> <td>0.300</td> <td>M</td> </tr> <tr> <td>MG1015B0</td> <td>L.MISS/L.MICR O/CHEFTOP HANDLE END</td> <td>2</td> <td>PZ</td> </tr> <tr> <td>TB1077A0</td> <td>XLT135/XLT19 5 Ø18X1 HANDLE TUBE</td> <td>1</td> <td>PZ</td> </tr> <tr> <td>VI1685A0</td> <td>M6X6 STAINLESS STEEL SCREW</td> <td>4</td> <td>PZ</td> </tr> <tr> <td>VI1930A0</td> <td>5X25 ST. STEEL SCREW CHIP</td> <td>2</td> <td>PZ</td> </tr> <tr> <td>VM1059A1</td> <td>HEAT SHRINK FILM H800</td> <td>1.500</td> <td>M</td> </tr> <tr> <td>VM1720A0</td> <td>XL405 DOOR WASKER</td> <td>1</td> <td>PZ</td> </tr> <tr> <td>VT1076B0</td> <td>XLT135/XLT13 3 BLACK DOOR GLASS 299X661</td> <td>1</td> <td>PZ</td> </tr> <tr> <td>VT1076B0</td> <td>XLT135/XLT13 3 BLACK DOOR GLASS 299X661</td> <td>1</td> <td>PZ</td> </tr> </tbody> </table> | Code | Description | Qty | UOM | 0H4540A0 | DOOR PLATES MAGNET XL40 | 1 | PZ | CR1080A0 | XV-XL-XB ST. STEEL RIGHT HINGE | 1 | PZ | CR1081A0 | XV-XL-XB ST. STEEL LEFT HINGE | 1 | PZ | GN1320A1 | DOOR GLASS GASKET | 2 | PZ | GN1330A0 | FERRITIC PLATE GASKET XL40 | 1 | PZ | IP1385A1 | CORNER POLYSTYREN E PACKING 110X80X2000 | 1.400 | M | IP1508A1 | POLYSTYREN E U SHAPED PROFILE 2000X60X60 | 0.300 | M | MG1015B0 | L.MISS/L.MICR O/CHEFTOP HANDLE END | 2 | PZ | TB1077A0 | XLT135/XLT19 5 Ø18X1 HANDLE TUBE | 1 | PZ | VI1685A0 | M6X6 STAINLESS STEEL SCREW | 4 | PZ | VI1930A0 | 5X25 ST. STEEL SCREW CHIP | 2 | PZ | VM1059A1 | HEAT SHRINK FILM H800 | 1.500 | M | VM1720A0 | XL405 DOOR WASKER | 1 | PZ | VT1076B0 | XLT135/XLT13 3 BLACK DOOR GLASS 299X661 | 1 | PZ | VT1076B0 | XLT135/XLT13 3 BLACK DOOR GLASS 299X661 | 1 | PZ | KVT1076BL | XLT135/XLT133 LEFT COMPLETE DOOR KIT | <table border="1"> <thead> <tr> <th>Code</th> <th>Description</th> <th>Qty</th> <th>UOM</th> </tr> </thead> <tbody> <tr> <td>0H4540A0</td> <td>DOOR PLATES MAGNET XL40</td> <td>1</td> <td>PZ</td> </tr> <tr> <td>CR1080A0</td> <td>XV-XL-XB ST. STEEL RIGHT HINGE</td> <td>1</td> <td>PZ</td> </tr> <tr> <td>CR1081A0</td> <td>XV-XL-XB ST. STEEL LEFT HINGE</td> <td>1</td> <td>PZ</td> </tr> </tbody> </table> | Code | Description | Qty | UOM | 0H4540A0 | DOOR PLATES MAGNET XL40 | 1 | PZ | CR1080A0 | XV-XL-XB ST. STEEL RIGHT HINGE | 1 | PZ | CR1081A0 | XV-XL-XB ST. STEEL LEFT HINGE | 1 | PZ |
| | | | Code | Description | Qty | UOM | | | | | | | | | | | | | | | | | | | | | | | | | | | | | | | | | | | | | | | | | | | | | | | | | | | | | | | | | | | | | | | | | | | | | | | | | | | | | | | | | | |
| 0H4540A0 | DOOR PLATES MAGNET XL40 | 1 | PZ | | | | | | | | | | | | | | | | | | | | | | | | | | | | | | | | | | | | | | | | | | | | | | | | | | | | | | | | | | | | | | | | | | | | | | | | | | | | | | | | | | | | | |
| CR1080A0 | XV-XL-XB ST. STEEL RIGHT HINGE | 1 | PZ | | | | | | | | | | | | | | | | | | | | | | | | | | | | | | | | | | | | | | | | | | | | | | | | | | | | | | | | | | | | | | | | | | | | | | | | | | | | | | | | | | | | | |
| CR1081A0 | XV-XL-XB ST. STEEL LEFT HINGE | 1 | PZ | | | | | | | | | | | | | | | | | | | | | | | | | | | | | | | | | | | | | | | | | | | | | | | | | | | | | | | | | | | | | | | | | | | | | | | | | | | | | | | | | | | | | |
| GN1320A1 | DOOR GLASS GASKET | 2 | PZ | | | | | | | | | | | | | | | | | | | | | | | | | | | | | | | | | | | | | | | | | | | | | | | | | | | | | | | | | | | | | | | | | | | | | | | | | | | | | | | | | | | | | |
| GN1330A0 | FERRITIC PLATE GASKET XL40 | 1 | PZ | | | | | | | | | | | | | | | | | | | | | | | | | | | | | | | | | | | | | | | | | | | | | | | | | | | | | | | | | | | | | | | | | | | | | | | | | | | | | | | | | | | | | |
| IP1385A1 | CORNER POLYSTYREN E PACKING 110X80X2000 | 1.400 | M | | | | | | | | | | | | | | | | | | | | | | | | | | | | | | | | | | | | | | | | | | | | | | | | | | | | | | | | | | | | | | | | | | | | | | | | | | | | | | | | | | | | | |
| IP1508A1 | POLYSTYREN E U SHAPED PROFILE 2000X60X60 | 0.300 | M | | | | | | | | | | | | | | | | | | | | | | | | | | | | | | | | | | | | | | | | | | | | | | | | | | | | | | | | | | | | | | | | | | | | | | | | | | | | | | | | | | | | | |
| MG1015B0 | L.MISS/L.MICR O/CHEFTOP HANDLE END | 2 | PZ | | | | | | | | | | | | | | | | | | | | | | | | | | | | | | | | | | | | | | | | | | | | | | | | | | | | | | | | | | | | | | | | | | | | | | | | | | | | | | | | | | | | | |
| TB1077A0 | XLT135/XLT19 5 Ø18X1 HANDLE TUBE | 1 | PZ | | | | | | | | | | | | | | | | | | | | | | | | | | | | | | | | | | | | | | | | | | | | | | | | | | | | | | | | | | | | | | | | | | | | | | | | | | | | | | | | | | | | | |
| VI1685A0 | M6X6 STAINLESS STEEL SCREW | 4 | PZ | | | | | | | | | | | | | | | | | | | | | | | | | | | | | | | | | | | | | | | | | | | | | | | | | | | | | | | | | | | | | | | | | | | | | | | | | | | | | | | | | | | | | |
| VI1930A0 | 5X25 ST. STEEL SCREW CHIP | 2 | PZ | | | | | | | | | | | | | | | | | | | | | | | | | | | | | | | | | | | | | | | | | | | | | | | | | | | | | | | | | | | | | | | | | | | | | | | | | | | | | | | | | | | | | |
| VM1059A1 | HEAT SHRINK FILM H800 | 1.500 | M | | | | | | | | | | | | | | | | | | | | | | | | | | | | | | | | | | | | | | | | | | | | | | | | | | | | | | | | | | | | | | | | | | | | | | | | | | | | | | | | | | | | | |
| VM1720A0 | XL405 DOOR WASKER | 1 | PZ | | | | | | | | | | | | | | | | | | | | | | | | | | | | | | | | | | | | | | | | | | | | | | | | | | | | | | | | | | | | | | | | | | | | | | | | | | | | | | | | | | | | | |
| VT1076B0 | XLT135/XLT13 3 BLACK DOOR GLASS 299X661 | 1 | PZ | | | | | | | | | | | | | | | | | | | | | | | | | | | | | | | | | | | | | | | | | | | | | | | | | | | | | | | | | | | | | | | | | | | | | | | | | | | | | | | | | | | | | |
| VT1076B0 | XLT135/XLT13 3 BLACK DOOR GLASS 299X661 | 1 | PZ | | | | | | | | | | | | | | | | | | | | | | | | | | | | | | | | | | | | | | | | | | | | | | | | | | | | | | | | | | | | | | | | | | | | | | | | | | | | | | | | | | | | | |
| Code | Description | Qty | UOM | | | | | | | | | | | | | | | | | | | | | | | | | | | | | | | | | | | | | | | | | | | | | | | | | | | | | | | | | | | | | | | | | | | | | | | | | | | | | | | | | | | | | |
| 0H4540A0 | DOOR PLATES MAGNET XL40 | 1 | PZ | | | | | | | | | | | | | | | | | | | | | | | | | | | | | | | | | | | | | | | | | | | | | | | | | | | | | | | | | | | | | | | | | | | | | | | | | | | | | | | | | | | | | |
| CR1080A0 | XV-XL-XB ST. STEEL RIGHT HINGE | 1 | PZ | | | | | | | | | | | | | | | | | | | | | | | | | | | | | | | | | | | | | | | | | | | | | | | | | | | | | | | | | | | | | | | | | | | | | | | | | | | | | | | | | | | | | |
| CR1081A0 | XV-XL-XB ST. STEEL LEFT HINGE | 1 | PZ | | | | | | | | | | | | | | | | | | | | | | | | | | | | | | | | | | | | | | | | | | | | | | | | | | | | | | | | | | | | | | | | | | | | | | | | | | | | | | | | | | | | | |

| COMPONENT | | | SPARE PART | | | | | | | | | | | | | | | | | | | | | | | | | | | | | | | | | | | | | | | | | | | | | | | | | | | | | | | | | | | | | | | | | | | | | | | | | | | | | | | | | | | | | |
|-----------|---|---|------------|--|---|------|-------------|-----|-----|----------|----------------------|---|----|----------|----------------------------------|---|----|----------|--|-------|---|----------|---|-------|---|----------|--|---|----|----------|--|---|----|----------|----------------------------------|---|----|----------|---------------------------------|---|----|----------|--------------------------|-------|---|----------|----------------------|---|----|----------|--|---|----|----------|--|---|----|-----------|------------------------------|--|------|-------------|-----|-----|----------|--------------------------------------|---|----|----------|----------------------------|---|----|----------|--------------------------------------|---|----|----------|-------------------------------------|---|----|----------|----------------------|---|----|----------|----------------------------------|---|----|
| Code | Description | Image | Code | Description | Components list | | | | | | | | | | | | | | | | | | | | | | | | | | | | | | | | | | | | | | | | | | | | | | | | | | | | | | | | | | | | | | | | | | | | | | | | | | | | | | | | | | | |
| GN1330A | FERRITIC PLATE GASKET XL405 |  | KVT1076BL | XLT135/XLT133 LEFT COMPLETE DOOR KIT | <table border="1"> <thead> <tr> <th>Code</th> <th>Description</th> <th>Qty</th> <th>UOM</th> </tr> </thead> <tbody> <tr> <td>GN1320A1</td> <td>DOOR GLASS GASKET</td> <td>2</td> <td>PZ</td> </tr> <tr> <td>GN1330A0</td> <td>FERRITIC PLATE GASKET XL40</td> <td>1</td> <td>PZ</td> </tr> <tr> <td>IP1385A1</td> <td>CORNER POLYSTYREN E PACKING 110X80X2000</td> <td>1.400</td> <td>M</td> </tr> <tr> <td>IP1508A1</td> <td>POLYSTYREN E U SHAPED PROFILE 2000X60X60</td> <td>0.300</td> <td>M</td> </tr> <tr> <td>MG1015B0</td> <td>L.MISS/L.MICR O/CHEFTOP HANDLE END</td> <td>2</td> <td>PZ</td> </tr> <tr> <td>TB1077A0</td> <td>XLT135/XLT19 5 Ø18X1 HANDLE TUBE</td> <td>1</td> <td>PZ</td> </tr> <tr> <td>VI1685A0</td> <td>M6X6 STAINLESS STEEL SCREW</td> <td>4</td> <td>PZ</td> </tr> <tr> <td>VI1930A0</td> <td>5X25 ST. STEEL SCREW CHIP</td> <td>2</td> <td>PZ</td> </tr> <tr> <td>VM1059A1</td> <td>HEAT SHRINK FILM H800</td> <td>1.500</td> <td>M</td> </tr> <tr> <td>VM1720A0</td> <td>XL405 DOOR WASKER</td> <td>1</td> <td>PZ</td> </tr> <tr> <td>VT1076B0</td> <td>XLT135/XLT13 3 BLACK DOOR GLASS 299X661</td> <td>1</td> <td>PZ</td> </tr> <tr> <td>VT1076B0</td> <td>XLT135/XLT13 3 BLACK DOOR GLASS 299X661</td> <td>1</td> <td>PZ</td> </tr> </tbody> </table> | Code | Description | Qty | UOM | GN1320A1 | DOOR GLASS GASKET | 2 | PZ | GN1330A0 | FERRITIC PLATE GASKET XL40 | 1 | PZ | IP1385A1 | CORNER POLYSTYREN E PACKING 110X80X2000 | 1.400 | M | IP1508A1 | POLYSTYREN E U SHAPED PROFILE 2000X60X60 | 0.300 | M | MG1015B0 | L.MISS/L.MICR O/CHEFTOP HANDLE END | 2 | PZ | TB1077A0 | XLT135/XLT19 5 Ø18X1 HANDLE TUBE | 1 | PZ | VI1685A0 | M6X6 STAINLESS STEEL SCREW | 4 | PZ | VI1930A0 | 5X25 ST. STEEL SCREW CHIP | 2 | PZ | VM1059A1 | HEAT SHRINK FILM H800 | 1.500 | M | VM1720A0 | XL405 DOOR WASKER | 1 | PZ | VT1076B0 | XLT135/XLT13 3 BLACK DOOR GLASS 299X661 | 1 | PZ | VT1076B0 | XLT135/XLT13 3 BLACK DOOR GLASS 299X661 | 1 | PZ | KDR1210AR | XL405 COMPLETE RIGHT DOOR | <table border="1"> <thead> <tr> <th>Code</th> <th>Description</th> <th>Qty</th> <th>UOM</th> </tr> </thead> <tbody> <tr> <td>0H4530C0</td> <td>RIGHT DOOR DRIPPING TRAY XL415</td> <td>1</td> <td>PZ</td> </tr> <tr> <td>0H4540A0</td> <td>DOOR PLATES MAGNET XL40</td> <td>1</td> <td>PZ</td> </tr> <tr> <td>CR1080A0</td> <td>XV-XL-XB ST. STEEL RIGHT HINGE</td> <td>1</td> <td>PZ</td> </tr> <tr> <td>CR1081A0</td> <td>XV-XL-XB ST. STEEL LEFT HINGE</td> <td>1</td> <td>PZ</td> </tr> <tr> <td>GN1320A1</td> <td>DOOR GLASS GASKET</td> <td>2</td> <td>PZ</td> </tr> <tr> <td>GN1330A0</td> <td>FERRITIC PLATE GASKET XL40</td> <td>1</td> <td>PZ</td> </tr> </tbody> </table> | Code | Description | Qty | UOM | 0H4530C0 | RIGHT DOOR DRIPPING TRAY XL415 | 1 | PZ | 0H4540A0 | DOOR PLATES MAGNET XL40 | 1 | PZ | CR1080A0 | XV-XL-XB ST. STEEL RIGHT HINGE | 1 | PZ | CR1081A0 | XV-XL-XB ST. STEEL LEFT HINGE | 1 | PZ | GN1320A1 | DOOR GLASS GASKET | 2 | PZ | GN1330A0 | FERRITIC PLATE GASKET XL40 | 1 | PZ |
| | | | Code | Description | Qty | UOM | | | | | | | | | | | | | | | | | | | | | | | | | | | | | | | | | | | | | | | | | | | | | | | | | | | | | | | | | | | | | | | | | | | | | | | | | | | | | | | | | | |
| GN1320A1 | DOOR GLASS GASKET | 2 | PZ | | | | | | | | | | | | | | | | | | | | | | | | | | | | | | | | | | | | | | | | | | | | | | | | | | | | | | | | | | | | | | | | | | | | | | | | | | | | | | | | | | | | | |
| GN1330A0 | FERRITIC PLATE GASKET XL40 | 1 | PZ | | | | | | | | | | | | | | | | | | | | | | | | | | | | | | | | | | | | | | | | | | | | | | | | | | | | | | | | | | | | | | | | | | | | | | | | | | | | | | | | | | | | | |
| IP1385A1 | CORNER POLYSTYREN E PACKING 110X80X2000 | 1.400 | M | | | | | | | | | | | | | | | | | | | | | | | | | | | | | | | | | | | | | | | | | | | | | | | | | | | | | | | | | | | | | | | | | | | | | | | | | | | | | | | | | | | | | |
| IP1508A1 | POLYSTYREN E U SHAPED PROFILE 2000X60X60 | 0.300 | M | | | | | | | | | | | | | | | | | | | | | | | | | | | | | | | | | | | | | | | | | | | | | | | | | | | | | | | | | | | | | | | | | | | | | | | | | | | | | | | | | | | | | |
| MG1015B0 | L.MISS/L.MICR O/CHEFTOP HANDLE END | 2 | PZ | | | | | | | | | | | | | | | | | | | | | | | | | | | | | | | | | | | | | | | | | | | | | | | | | | | | | | | | | | | | | | | | | | | | | | | | | | | | | | | | | | | | | |
| TB1077A0 | XLT135/XLT19 5 Ø18X1 HANDLE TUBE | 1 | PZ | | | | | | | | | | | | | | | | | | | | | | | | | | | | | | | | | | | | | | | | | | | | | | | | | | | | | | | | | | | | | | | | | | | | | | | | | | | | | | | | | | | | | |
| VI1685A0 | M6X6 STAINLESS STEEL SCREW | 4 | PZ | | | | | | | | | | | | | | | | | | | | | | | | | | | | | | | | | | | | | | | | | | | | | | | | | | | | | | | | | | | | | | | | | | | | | | | | | | | | | | | | | | | | | |
| VI1930A0 | 5X25 ST. STEEL SCREW CHIP | 2 | PZ | | | | | | | | | | | | | | | | | | | | | | | | | | | | | | | | | | | | | | | | | | | | | | | | | | | | | | | | | | | | | | | | | | | | | | | | | | | | | | | | | | | | | |
| VM1059A1 | HEAT SHRINK FILM H800 | 1.500 | M | | | | | | | | | | | | | | | | | | | | | | | | | | | | | | | | | | | | | | | | | | | | | | | | | | | | | | | | | | | | | | | | | | | | | | | | | | | | | | | | | | | | | |
| VM1720A0 | XL405 DOOR WASKER | 1 | PZ | | | | | | | | | | | | | | | | | | | | | | | | | | | | | | | | | | | | | | | | | | | | | | | | | | | | | | | | | | | | | | | | | | | | | | | | | | | | | | | | | | | | | |
| VT1076B0 | XLT135/XLT13 3 BLACK DOOR GLASS 299X661 | 1 | PZ | | | | | | | | | | | | | | | | | | | | | | | | | | | | | | | | | | | | | | | | | | | | | | | | | | | | | | | | | | | | | | | | | | | | | | | | | | | | | | | | | | | | | |
| VT1076B0 | XLT135/XLT13 3 BLACK DOOR GLASS 299X661 | 1 | PZ | | | | | | | | | | | | | | | | | | | | | | | | | | | | | | | | | | | | | | | | | | | | | | | | | | | | | | | | | | | | | | | | | | | | | | | | | | | | | | | | | | | | | |
| Code | Description | Qty | UOM | | | | | | | | | | | | | | | | | | | | | | | | | | | | | | | | | | | | | | | | | | | | | | | | | | | | | | | | | | | | | | | | | | | | | | | | | | | | | | | | | | | | | |
| 0H4530C0 | RIGHT DOOR DRIPPING TRAY XL415 | 1 | PZ | | | | | | | | | | | | | | | | | | | | | | | | | | | | | | | | | | | | | | | | | | | | | | | | | | | | | | | | | | | | | | | | | | | | | | | | | | | | | | | | | | | | | |
| 0H4540A0 | DOOR PLATES MAGNET XL40 | 1 | PZ | | | | | | | | | | | | | | | | | | | | | | | | | | | | | | | | | | | | | | | | | | | | | | | | | | | | | | | | | | | | | | | | | | | | | | | | | | | | | | | | | | | | | |
| CR1080A0 | XV-XL-XB ST. STEEL RIGHT HINGE | 1 | PZ | | | | | | | | | | | | | | | | | | | | | | | | | | | | | | | | | | | | | | | | | | | | | | | | | | | | | | | | | | | | | | | | | | | | | | | | | | | | | | | | | | | | | |
| CR1081A0 | XV-XL-XB ST. STEEL LEFT HINGE | 1 | PZ | | | | | | | | | | | | | | | | | | | | | | | | | | | | | | | | | | | | | | | | | | | | | | | | | | | | | | | | | | | | | | | | | | | | | | | | | | | | | | | | | | | | | |
| GN1320A1 | DOOR GLASS GASKET | 2 | PZ | | | | | | | | | | | | | | | | | | | | | | | | | | | | | | | | | | | | | | | | | | | | | | | | | | | | | | | | | | | | | | | | | | | | | | | | | | | | | | | | | | | | | |
| GN1330A0 | FERRITIC PLATE GASKET XL40 | 1 | PZ | | | | | | | | | | | | | | | | | | | | | | | | | | | | | | | | | | | | | | | | | | | | | | | | | | | | | | | | | | | | | | | | | | | | | | | | | | | | | | | | | | | | | |

| COMPONENT | | | SPARE PART | | | | | | | | | | | | | | | | | | | | | | | | | | | | | | | | | | | | | | | | | | | | | | | | | | | | | | | | | | | | | | | | | | | | | | | | | | | | | | | | | | | | | | | | | |
|-----------|---|---|------------|------------------------------|--|------|-------------|-----|-----|----------|--|-------|---|----------|---|-------|---|----------|--|---|----|----------|------------------------------|---|----|----------|----------------------------------|---|----|----------|---------------------------------|---|----|----------|--------------------------|-------|---|----------|----------------------|---|----|----------|----------------------------|---|----|----------|-----------------------------|---|----|----------|-----------------------------|---|----|-----------|-----------------------------|--|------|-------------|-----|-----|----------|-------------------------------------|---|----|----------|----------------------------|---|----|----------|--------------------------------------|---|----|----------|-------------------------------------|---|----|----------|----------------------|---|----|----------|----------------------------------|---|----|----------|--|-------|---|----------|---|-------|---|
| Code | Description | Image | Code | Description | Components list | | | | | | | | | | | | | | | | | | | | | | | | | | | | | | | | | | | | | | | | | | | | | | | | | | | | | | | | | | | | | | | | | | | | | | | | | | | | | | | | | | | | | | | |
| GN1330A | FERRITIC PLATE GASKET XL405 |  | KDR1210AR | XL405 COMPLETE RIGHT DOOR | <table border="1"> <thead> <tr> <th>Code</th> <th>Description</th> <th>Qty</th> <th>UOM</th> </tr> </thead> <tbody> <tr> <td>IP1385A1</td> <td>CORNER POLYSTYREN E PACKING 110X80X2000</td> <td>1.300</td> <td>M</td> </tr> <tr> <td>IP1508A1</td> <td>POLYSTYREN E U SHAPED PROFILE 2000X60X60</td> <td>0.570</td> <td>M</td> </tr> <tr> <td>MG1015B0</td> <td>L.MISS/L.MICR O/CHEFTOP HANDLE END</td> <td>2</td> <td>PZ</td> </tr> <tr> <td>TB1730A0</td> <td>XL405-413-415 HANDLE TUBE</td> <td>1</td> <td>PZ</td> </tr> <tr> <td>VI1685A0</td> <td>M6X6 STAINLESS STEEL SCREW</td> <td>4</td> <td>PZ</td> </tr> <tr> <td>VI1930A0</td> <td>5X25 ST. STEEL SCREW CHIP</td> <td>2</td> <td>PZ</td> </tr> <tr> <td>VM1059A1</td> <td>HEAT SHRINK FILM H800</td> <td>1.300</td> <td>M</td> </tr> <tr> <td>VM1720A0</td> <td>XL405 DOOR WASKER</td> <td>1</td> <td>PZ</td> </tr> <tr> <td>VM1790A0</td> <td>HINGE BUSH 12X6.5 DI5.3</td> <td>2</td> <td>PZ</td> </tr> <tr> <td>VT1210A0</td> <td>XL405-413-415 DOOR GLASS</td> <td>1</td> <td>PZ</td> </tr> <tr> <td>VT1210A0</td> <td>XL405-413-415 DOOR GLASS</td> <td>1</td> <td>PZ</td> </tr> </tbody> </table> | Code | Description | Qty | UOM | IP1385A1 | CORNER POLYSTYREN E PACKING 110X80X2000 | 1.300 | M | IP1508A1 | POLYSTYREN E U SHAPED PROFILE 2000X60X60 | 0.570 | M | MG1015B0 | L.MISS/L.MICR O/CHEFTOP HANDLE END | 2 | PZ | TB1730A0 | XL405-413-415 HANDLE TUBE | 1 | PZ | VI1685A0 | M6X6 STAINLESS STEEL SCREW | 4 | PZ | VI1930A0 | 5X25 ST. STEEL SCREW CHIP | 2 | PZ | VM1059A1 | HEAT SHRINK FILM H800 | 1.300 | M | VM1720A0 | XL405 DOOR WASKER | 1 | PZ | VM1790A0 | HINGE BUSH 12X6.5 DI5.3 | 2 | PZ | VT1210A0 | XL405-413-415 DOOR GLASS | 1 | PZ | VT1210A0 | XL405-413-415 DOOR GLASS | 1 | PZ | KDR1210AL | XL405 COMPLETE LEFT DOOR | <table border="1"> <thead> <tr> <th>Code</th> <th>Description</th> <th>Qty</th> <th>UOM</th> </tr> </thead> <tbody> <tr> <td>0H4535C0</td> <td>LEFT DOOR DRIPPING TRAY XL415</td> <td>1</td> <td>PZ</td> </tr> <tr> <td>0H4540A0</td> <td>DOOR PLATES MAGNET XL40</td> <td>1</td> <td>PZ</td> </tr> <tr> <td>CR1080A0</td> <td>XV-XL-XB ST. STEEL RIGHT HINGE</td> <td>1</td> <td>PZ</td> </tr> <tr> <td>CR1081A0</td> <td>XV-XL-XB ST. STEEL LEFT HINGE</td> <td>1</td> <td>PZ</td> </tr> <tr> <td>GN1320A1</td> <td>DOOR GLASS GASKET</td> <td>2</td> <td>PZ</td> </tr> <tr> <td>GN1330A0</td> <td>FERRITIC PLATE GASKET XL40</td> <td>1</td> <td>PZ</td> </tr> <tr> <td>IP1385A1</td> <td>CORNER POLYSTYREN E PACKING 110X80X2000</td> <td>1.300</td> <td>M</td> </tr> <tr> <td>IP1508A1</td> <td>POLYSTYREN E U SHAPED PROFILE 2000X60X60</td> <td>0.570</td> <td>M</td> </tr> </tbody> </table> | Code | Description | Qty | UOM | 0H4535C0 | LEFT DOOR DRIPPING TRAY XL415 | 1 | PZ | 0H4540A0 | DOOR PLATES MAGNET XL40 | 1 | PZ | CR1080A0 | XV-XL-XB ST. STEEL RIGHT HINGE | 1 | PZ | CR1081A0 | XV-XL-XB ST. STEEL LEFT HINGE | 1 | PZ | GN1320A1 | DOOR GLASS GASKET | 2 | PZ | GN1330A0 | FERRITIC PLATE GASKET XL40 | 1 | PZ | IP1385A1 | CORNER POLYSTYREN E PACKING 110X80X2000 | 1.300 | M | IP1508A1 | POLYSTYREN E U SHAPED PROFILE 2000X60X60 | 0.570 | M |
| | | | Code | Description | Qty | UOM | | | | | | | | | | | | | | | | | | | | | | | | | | | | | | | | | | | | | | | | | | | | | | | | | | | | | | | | | | | | | | | | | | | | | | | | | | | | | | | | | | | | | | |
| IP1385A1 | CORNER POLYSTYREN E PACKING 110X80X2000 | 1.300 | M | | | | | | | | | | | | | | | | | | | | | | | | | | | | | | | | | | | | | | | | | | | | | | | | | | | | | | | | | | | | | | | | | | | | | | | | | | | | | | | | | | | | | | | | | |
| IP1508A1 | POLYSTYREN E U SHAPED PROFILE 2000X60X60 | 0.570 | M | | | | | | | | | | | | | | | | | | | | | | | | | | | | | | | | | | | | | | | | | | | | | | | | | | | | | | | | | | | | | | | | | | | | | | | | | | | | | | | | | | | | | | | | | |
| MG1015B0 | L.MISS/L.MICR O/CHEFTOP HANDLE END | 2 | PZ | | | | | | | | | | | | | | | | | | | | | | | | | | | | | | | | | | | | | | | | | | | | | | | | | | | | | | | | | | | | | | | | | | | | | | | | | | | | | | | | | | | | | | | | | |
| TB1730A0 | XL405-413-415 HANDLE TUBE | 1 | PZ | | | | | | | | | | | | | | | | | | | | | | | | | | | | | | | | | | | | | | | | | | | | | | | | | | | | | | | | | | | | | | | | | | | | | | | | | | | | | | | | | | | | | | | | | |
| VI1685A0 | M6X6 STAINLESS STEEL SCREW | 4 | PZ | | | | | | | | | | | | | | | | | | | | | | | | | | | | | | | | | | | | | | | | | | | | | | | | | | | | | | | | | | | | | | | | | | | | | | | | | | | | | | | | | | | | | | | | | |
| VI1930A0 | 5X25 ST. STEEL SCREW CHIP | 2 | PZ | | | | | | | | | | | | | | | | | | | | | | | | | | | | | | | | | | | | | | | | | | | | | | | | | | | | | | | | | | | | | | | | | | | | | | | | | | | | | | | | | | | | | | | | | |
| VM1059A1 | HEAT SHRINK FILM H800 | 1.300 | M | | | | | | | | | | | | | | | | | | | | | | | | | | | | | | | | | | | | | | | | | | | | | | | | | | | | | | | | | | | | | | | | | | | | | | | | | | | | | | | | | | | | | | | | | |
| VM1720A0 | XL405 DOOR WASKER | 1 | PZ | | | | | | | | | | | | | | | | | | | | | | | | | | | | | | | | | | | | | | | | | | | | | | | | | | | | | | | | | | | | | | | | | | | | | | | | | | | | | | | | | | | | | | | | | |
| VM1790A0 | HINGE BUSH 12X6.5 DI5.3 | 2 | PZ | | | | | | | | | | | | | | | | | | | | | | | | | | | | | | | | | | | | | | | | | | | | | | | | | | | | | | | | | | | | | | | | | | | | | | | | | | | | | | | | | | | | | | | | | |
| VT1210A0 | XL405-413-415 DOOR GLASS | 1 | PZ | | | | | | | | | | | | | | | | | | | | | | | | | | | | | | | | | | | | | | | | | | | | | | | | | | | | | | | | | | | | | | | | | | | | | | | | | | | | | | | | | | | | | | | | | |
| VT1210A0 | XL405-413-415 DOOR GLASS | 1 | PZ | | | | | | | | | | | | | | | | | | | | | | | | | | | | | | | | | | | | | | | | | | | | | | | | | | | | | | | | | | | | | | | | | | | | | | | | | | | | | | | | | | | | | | | | | |
| Code | Description | Qty | UOM | | | | | | | | | | | | | | | | | | | | | | | | | | | | | | | | | | | | | | | | | | | | | | | | | | | | | | | | | | | | | | | | | | | | | | | | | | | | | | | | | | | | | | | | | |
| 0H4535C0 | LEFT DOOR DRIPPING TRAY XL415 | 1 | PZ | | | | | | | | | | | | | | | | | | | | | | | | | | | | | | | | | | | | | | | | | | | | | | | | | | | | | | | | | | | | | | | | | | | | | | | | | | | | | | | | | | | | | | | | | |
| 0H4540A0 | DOOR PLATES MAGNET XL40 | 1 | PZ | | | | | | | | | | | | | | | | | | | | | | | | | | | | | | | | | | | | | | | | | | | | | | | | | | | | | | | | | | | | | | | | | | | | | | | | | | | | | | | | | | | | | | | | | |
| CR1080A0 | XV-XL-XB ST. STEEL RIGHT HINGE | 1 | PZ | | | | | | | | | | | | | | | | | | | | | | | | | | | | | | | | | | | | | | | | | | | | | | | | | | | | | | | | | | | | | | | | | | | | | | | | | | | | | | | | | | | | | | | | | |
| CR1081A0 | XV-XL-XB ST. STEEL LEFT HINGE | 1 | PZ | | | | | | | | | | | | | | | | | | | | | | | | | | | | | | | | | | | | | | | | | | | | | | | | | | | | | | | | | | | | | | | | | | | | | | | | | | | | | | | | | | | | | | | | | |
| GN1320A1 | DOOR GLASS GASKET | 2 | PZ | | | | | | | | | | | | | | | | | | | | | | | | | | | | | | | | | | | | | | | | | | | | | | | | | | | | | | | | | | | | | | | | | | | | | | | | | | | | | | | | | | | | | | | | | |
| GN1330A0 | FERRITIC PLATE GASKET XL40 | 1 | PZ | | | | | | | | | | | | | | | | | | | | | | | | | | | | | | | | | | | | | | | | | | | | | | | | | | | | | | | | | | | | | | | | | | | | | | | | | | | | | | | | | | | | | | | | | |
| IP1385A1 | CORNER POLYSTYREN E PACKING 110X80X2000 | 1.300 | M | | | | | | | | | | | | | | | | | | | | | | | | | | | | | | | | | | | | | | | | | | | | | | | | | | | | | | | | | | | | | | | | | | | | | | | | | | | | | | | | | | | | | | | | | |
| IP1508A1 | POLYSTYREN E U SHAPED PROFILE 2000X60X60 | 0.570 | M | | | | | | | | | | | | | | | | | | | | | | | | | | | | | | | | | | | | | | | | | | | | | | | | | | | | | | | | | | | | | | | | | | | | | | | | | | | | | | | | | | | | | | | | | |



| COMPONENT | | | SPARE PART | | | | | | | | | | | | | | | | | | | | | | | | | | | | | | | | | | | | | | | | | | | | | | | | | | | | | | |
|-----------|--|---|------------|---|--|--|-------------|-----|-----|----------|--|---|----|----------|--------------------------------------|---|----|----------|-------------------------------------|---|----|----------|---------------------------------|---|----|----------|----------------------------------|-------|----|----------|--|---|----|----------|--|---|----|----------|----------------------------------|---|----|----------|---------------------------------|---|----|----------|----------------------|---|----|----------|--|---|----|----------|--|---|----|
| Code | Description | Image | Code | Description | Components list | | | | | | | | | | | | | | | | | | | | | | | | | | | | | | | | | | | | | | | | | | | | | | | | | | | | |
| GN1330A | FERRITIC PLATE GASKET XL405 |  | KDR1210AL | XL405 COMPLETE LEFT DOOR | <table border="1"> <thead> <tr> <th>Code</th> <th>Description</th> <th>Qty</th> <th>UOM</th> </tr> </thead> <tbody> <tr> <td>MG1015B0</td> <td>L.MISS/L.MICR O/CHEFTOP HANDLE END</td> <td>2</td> <td>PZ</td> </tr> <tr> <td>TB1730A0</td> <td>XL405-413-415 HANDLE TUBE</td> <td>1</td> <td>PZ</td> </tr> <tr> <td>VI1685A0</td> <td>M6X6 STAINLESS STEEL SCREW</td> <td>4</td> <td>PZ</td> </tr> <tr> <td>VI1930A0</td> <td>5X25 ST. STEEL SCREW CHIP</td> <td>2</td> <td>PZ</td> </tr> <tr> <td>VM1059A1</td> <td>HEAT SHRINK FILM H800</td> <td>1.300</td> <td>M</td> </tr> <tr> <td>VM1720A0</td> <td>XL405 DOOR WASKER</td> <td>1</td> <td>PZ</td> </tr> <tr> <td>VM1790A0</td> <td>HINGE BUSH 12X6.5 DI5.3</td> <td>2</td> <td>PZ</td> </tr> <tr> <td>VT1210A0</td> <td>XL405-413-415 DOOR GLASS</td> <td>1</td> <td>PZ</td> </tr> <tr> <td>VT1210A0</td> <td>XL405-413-415 DOOR GLASS</td> <td>1</td> <td>PZ</td> </tr> </tbody> </table> | Code | Description | Qty | UOM | MG1015B0 | L.MISS/L.MICR O/CHEFTOP HANDLE END | 2 | PZ | TB1730A0 | XL405-413-415 HANDLE TUBE | 1 | PZ | VI1685A0 | M6X6 STAINLESS STEEL SCREW | 4 | PZ | VI1930A0 | 5X25 ST. STEEL SCREW CHIP | 2 | PZ | VM1059A1 | HEAT SHRINK FILM H800 | 1.300 | M | VM1720A0 | XL405 DOOR WASKER | 1 | PZ | VM1790A0 | HINGE BUSH 12X6.5 DI5.3 | 2 | PZ | VT1210A0 | XL405-413-415 DOOR GLASS | 1 | PZ | VT1210A0 | XL405-413-415 DOOR GLASS | 1 | PZ | | | | | | | | | | | | |
| | | | | | Code | Description | Qty | UOM | | | | | | | | | | | | | | | | | | | | | | | | | | | | | | | | | | | | | | | | | | | | | | | | | |
| | | | | | MG1015B0 | L.MISS/L.MICR O/CHEFTOP HANDLE END | 2 | PZ | | | | | | | | | | | | | | | | | | | | | | | | | | | | | | | | | | | | | | | | | | | | | | | | | |
| | | | | | TB1730A0 | XL405-413-415 HANDLE TUBE | 1 | PZ | | | | | | | | | | | | | | | | | | | | | | | | | | | | | | | | | | | | | | | | | | | | | | | | | |
| | | | | | VI1685A0 | M6X6 STAINLESS STEEL SCREW | 4 | PZ | | | | | | | | | | | | | | | | | | | | | | | | | | | | | | | | | | | | | | | | | | | | | | | | | |
| | | | | | VI1930A0 | 5X25 ST. STEEL SCREW CHIP | 2 | PZ | | | | | | | | | | | | | | | | | | | | | | | | | | | | | | | | | | | | | | | | | | | | | | | | | |
| | | | | | VM1059A1 | HEAT SHRINK FILM H800 | 1.300 | M | | | | | | | | | | | | | | | | | | | | | | | | | | | | | | | | | | | | | | | | | | | | | | | | | |
| | | | | | VM1720A0 | XL405 DOOR WASKER | 1 | PZ | | | | | | | | | | | | | | | | | | | | | | | | | | | | | | | | | | | | | | | | | | | | | | | | | |
| | | | | | VM1790A0 | HINGE BUSH 12X6.5 DI5.3 | 2 | PZ | | | | | | | | | | | | | | | | | | | | | | | | | | | | | | | | | | | | | | | | | | | | | | | | | |
| | | | | | VT1210A0 | XL405-413-415 DOOR GLASS | 1 | PZ | | | | | | | | | | | | | | | | | | | | | | | | | | | | | | | | | | | | | | | | | | | | | | | | | |
| VT1210A0 | XL405-413-415 DOOR GLASS | 1 | PZ | | | | | | | | | | | | | | | | | | | | | | | | | | | | | | | | | | | | | | | | | | | | | | | | | | | | | | |
| VT1086B | XLT195\XLT193 DOOR BLACK GLASS 399X661 |  | KVT1086BR | XLT195/XLT193 RIGHT COMPLETE DOOR KIT | <table border="1"> <thead> <tr> <th>Code</th> <th>Description</th> <th>Qty</th> <th>UOM</th> </tr> </thead> <tbody> <tr> <td>0H4540A0</td> <td>DOOR PLATES MAGNET XL40</td> <td>1</td> <td>PZ</td> </tr> <tr> <td>CR1080A0</td> <td>XV-XL-XB ST. STEEL RIGHT HINGE</td> <td>1</td> <td>PZ</td> </tr> <tr> <td>CR1081A0</td> <td>XV-XL-XB ST. STEEL LEFT HINGE</td> <td>1</td> <td>PZ</td> </tr> <tr> <td>GN1320A1</td> <td>DOOR GLASS GASKET</td> <td>2</td> <td>PZ</td> </tr> <tr> <td>GN1330A0</td> <td>FERRITIC PLATE GASKET XL40</td> <td>1</td> <td>PZ</td> </tr> <tr> <td>MG1015B0</td> <td>L.MISS/L.MICR O/CHEFTOP HANDLE END</td> <td>2</td> <td>PZ</td> </tr> <tr> <td>TB1077A0</td> <td>XLT135/XLT19 5 Ø18X1 HANDLE TUBE</td> <td>1</td> <td>PZ</td> </tr> <tr> <td>VI1685A0</td> <td>M6X6 STAINLESS STEEL SCREW</td> <td>4</td> <td>PZ</td> </tr> <tr> <td>VI1930A0</td> <td>5X25 ST. STEEL SCREW CHIP</td> <td>2</td> <td>PZ</td> </tr> <tr> <td>VM1720A0</td> <td>XL405 DOOR WASKER</td> <td>1</td> <td>PZ</td> </tr> <tr> <td>VT1086B0</td> <td>XLT195\XLT19 3 DOOR BLACK GLASS 399X661</td> <td>1</td> <td>PZ</td> </tr> <tr> <td>VT1086B0</td> <td>XLT195\XLT19 3 DOOR BLACK GLASS 399X661</td> <td>1</td> <td>PZ</td> </tr> </tbody> </table> | Code | Description | Qty | UOM | 0H4540A0 | DOOR PLATES MAGNET XL40 | 1 | PZ | CR1080A0 | XV-XL-XB ST. STEEL RIGHT HINGE | 1 | PZ | CR1081A0 | XV-XL-XB ST. STEEL LEFT HINGE | 1 | PZ | GN1320A1 | DOOR GLASS GASKET | 2 | PZ | GN1330A0 | FERRITIC PLATE GASKET XL40 | 1 | PZ | MG1015B0 | L.MISS/L.MICR O/CHEFTOP HANDLE END | 2 | PZ | TB1077A0 | XLT135/XLT19 5 Ø18X1 HANDLE TUBE | 1 | PZ | VI1685A0 | M6X6 STAINLESS STEEL SCREW | 4 | PZ | VI1930A0 | 5X25 ST. STEEL SCREW CHIP | 2 | PZ | VM1720A0 | XL405 DOOR WASKER | 1 | PZ | VT1086B0 | XLT195\XLT19 3 DOOR BLACK GLASS 399X661 | 1 | PZ | VT1086B0 | XLT195\XLT19 3 DOOR BLACK GLASS 399X661 | 1 | PZ |
| | | | | | Code | Description | Qty | UOM | | | | | | | | | | | | | | | | | | | | | | | | | | | | | | | | | | | | | | | | | | | | | | | | | |
| | | | | | 0H4540A0 | DOOR PLATES MAGNET XL40 | 1 | PZ | | | | | | | | | | | | | | | | | | | | | | | | | | | | | | | | | | | | | | | | | | | | | | | | | |
| | | | | | CR1080A0 | XV-XL-XB ST. STEEL RIGHT HINGE | 1 | PZ | | | | | | | | | | | | | | | | | | | | | | | | | | | | | | | | | | | | | | | | | | | | | | | | | |
| | | | | | CR1081A0 | XV-XL-XB ST. STEEL LEFT HINGE | 1 | PZ | | | | | | | | | | | | | | | | | | | | | | | | | | | | | | | | | | | | | | | | | | | | | | | | | |
| | | | | | GN1320A1 | DOOR GLASS GASKET | 2 | PZ | | | | | | | | | | | | | | | | | | | | | | | | | | | | | | | | | | | | | | | | | | | | | | | | | |
| | | | | | GN1330A0 | FERRITIC PLATE GASKET XL40 | 1 | PZ | | | | | | | | | | | | | | | | | | | | | | | | | | | | | | | | | | | | | | | | | | | | | | | | | |
| | | | | | MG1015B0 | L.MISS/L.MICR O/CHEFTOP HANDLE END | 2 | PZ | | | | | | | | | | | | | | | | | | | | | | | | | | | | | | | | | | | | | | | | | | | | | | | | | |
| | | | | | TB1077A0 | XLT135/XLT19 5 Ø18X1 HANDLE TUBE | 1 | PZ | | | | | | | | | | | | | | | | | | | | | | | | | | | | | | | | | | | | | | | | | | | | | | | | | |
| | | | | | VI1685A0 | M6X6 STAINLESS STEEL SCREW | 4 | PZ | | | | | | | | | | | | | | | | | | | | | | | | | | | | | | | | | | | | | | | | | | | | | | | | | |
| | | | | | VI1930A0 | 5X25 ST. STEEL SCREW CHIP | 2 | PZ | | | | | | | | | | | | | | | | | | | | | | | | | | | | | | | | | | | | | | | | | | | | | | | | | |
| | | | | | VM1720A0 | XL405 DOOR WASKER | 1 | PZ | | | | | | | | | | | | | | | | | | | | | | | | | | | | | | | | | | | | | | | | | | | | | | | | | |
| | | | | | VT1086B0 | XLT195\XLT19 3 DOOR BLACK GLASS 399X661 | 1 | PZ | | | | | | | | | | | | | | | | | | | | | | | | | | | | | | | | | | | | | | | | | | | | | | | | | |
| | | | | | VT1086B0 | XLT195\XLT19 3 DOOR BLACK GLASS 399X661 | 1 | PZ | | | | | | | | | | | | | | | | | | | | | | | | | | | | | | | | | | | | | | | | | | | | | | | | | |





| COMPONENT | | | SPARE PART | | | | | | | | | | | | | | | | | | | | | | | | | | | | | | | | | | | | | | | | | | | | | | | | | | | | | | |
|-----------|--|---|------------|--|--|--|-------------|-----|-----|----------|----------------------------------|---|----|----------|--------------------------------------|---|----|----------|-------------------------------------|---|----|----------|----------------------|---|----|----------|----------------------------------|---|----|----------|--|---|----|----------|--|---|----|----------|----------------------------------|---|----|----------|---------------------------------|---|----|----------|----------------------|---|----|----------|--|---|----|----------|--|---|----|
| Code | Description | Image | Code | Description | Components list | | | | | | | | | | | | | | | | | | | | | | | | | | | | | | | | | | | | | | | | | | | | | | | | | | | | |
| VT1086B | XLT195\XLT193 DOOR BLACK GLASS 399X661 |  | KVT1086BL | XLT195/XLT193 LEFT COMPLETE DOOR KIT | <table border="1"> <thead> <tr> <th>Code</th> <th>Description</th> <th>Qty</th> <th>UOM</th> </tr> </thead> <tbody> <tr> <td>0H4540A0</td> <td>DOOR PLATES MAGNET XL40</td> <td>1</td> <td>PZ</td> </tr> <tr> <td>CR1080A0</td> <td>XV-XL-XB ST. STEEL RIGHT HINGE</td> <td>1</td> <td>PZ</td> </tr> <tr> <td>CR1081A0</td> <td>XV-XL-XB ST. STEEL LEFT HINGE</td> <td>1</td> <td>PZ</td> </tr> <tr> <td>GN1320A1</td> <td>DOOR GLASS GASKET</td> <td>2</td> <td>PZ</td> </tr> <tr> <td>GN1330A0</td> <td>FERRITIC PLATE GASKET XL40</td> <td>1</td> <td>PZ</td> </tr> <tr> <td>MG1015B0</td> <td>L.MISS/L.MICR O/CHEFTOP HANDLE END</td> <td>2</td> <td>PZ</td> </tr> <tr> <td>TB1077A0</td> <td>XLT135/XLT19 5 Ø18X1 HANDLE TUBE</td> <td>1</td> <td>PZ</td> </tr> <tr> <td>VI1685A0</td> <td>M6X6 STAINLESS STEEL SCREW</td> <td>4</td> <td>PZ</td> </tr> <tr> <td>VI1930A0</td> <td>5X25 ST. STEEL SCREW CHIP</td> <td>2</td> <td>PZ</td> </tr> <tr> <td>VM1720A0</td> <td>XL405 DOOR WASKER</td> <td>1</td> <td>PZ</td> </tr> <tr> <td>VT1086B0</td> <td>XLT195\XLT19 3 DOOR BLACK GLASS 399X661</td> <td>1</td> <td>PZ</td> </tr> <tr> <td>VT1086B0</td> <td>XLT195\XLT19 3 DOOR BLACK GLASS 399X661</td> <td>1</td> <td>PZ</td> </tr> </tbody> </table> | Code | Description | Qty | UOM | 0H4540A0 | DOOR PLATES MAGNET XL40 | 1 | PZ | CR1080A0 | XV-XL-XB ST. STEEL RIGHT HINGE | 1 | PZ | CR1081A0 | XV-XL-XB ST. STEEL LEFT HINGE | 1 | PZ | GN1320A1 | DOOR GLASS GASKET | 2 | PZ | GN1330A0 | FERRITIC PLATE GASKET XL40 | 1 | PZ | MG1015B0 | L.MISS/L.MICR O/CHEFTOP HANDLE END | 2 | PZ | TB1077A0 | XLT135/XLT19 5 Ø18X1 HANDLE TUBE | 1 | PZ | VI1685A0 | M6X6 STAINLESS STEEL SCREW | 4 | PZ | VI1930A0 | 5X25 ST. STEEL SCREW CHIP | 2 | PZ | VM1720A0 | XL405 DOOR WASKER | 1 | PZ | VT1086B0 | XLT195\XLT19 3 DOOR BLACK GLASS 399X661 | 1 | PZ | VT1086B0 | XLT195\XLT19 3 DOOR BLACK GLASS 399X661 | 1 | PZ |
| | | | | | Code | Description | Qty | UOM | | | | | | | | | | | | | | | | | | | | | | | | | | | | | | | | | | | | | | | | | | | | | | | | | |
| | | | | | 0H4540A0 | DOOR PLATES MAGNET XL40 | 1 | PZ | | | | | | | | | | | | | | | | | | | | | | | | | | | | | | | | | | | | | | | | | | | | | | | | | |
| | | | | | CR1080A0 | XV-XL-XB ST. STEEL RIGHT HINGE | 1 | PZ | | | | | | | | | | | | | | | | | | | | | | | | | | | | | | | | | | | | | | | | | | | | | | | | | |
| | | | | | CR1081A0 | XV-XL-XB ST. STEEL LEFT HINGE | 1 | PZ | | | | | | | | | | | | | | | | | | | | | | | | | | | | | | | | | | | | | | | | | | | | | | | | | |
| | | | | | GN1320A1 | DOOR GLASS GASKET | 2 | PZ | | | | | | | | | | | | | | | | | | | | | | | | | | | | | | | | | | | | | | | | | | | | | | | | | |
| | | | | | GN1330A0 | FERRITIC PLATE GASKET XL40 | 1 | PZ | | | | | | | | | | | | | | | | | | | | | | | | | | | | | | | | | | | | | | | | | | | | | | | | | |
| | | | | | MG1015B0 | L.MISS/L.MICR O/CHEFTOP HANDLE END | 2 | PZ | | | | | | | | | | | | | | | | | | | | | | | | | | | | | | | | | | | | | | | | | | | | | | | | | |
| | | | | | TB1077A0 | XLT135/XLT19 5 Ø18X1 HANDLE TUBE | 1 | PZ | | | | | | | | | | | | | | | | | | | | | | | | | | | | | | | | | | | | | | | | | | | | | | | | | |
| | | | | | VI1685A0 | M6X6 STAINLESS STEEL SCREW | 4 | PZ | | | | | | | | | | | | | | | | | | | | | | | | | | | | | | | | | | | | | | | | | | | | | | | | | |
| | | | | | VI1930A0 | 5X25 ST. STEEL SCREW CHIP | 2 | PZ | | | | | | | | | | | | | | | | | | | | | | | | | | | | | | | | | | | | | | | | | | | | | | | | | |
| | | | | | VM1720A0 | XL405 DOOR WASKER | 1 | PZ | | | | | | | | | | | | | | | | | | | | | | | | | | | | | | | | | | | | | | | | | | | | | | | | | |
| | | | | | VT1086B0 | XLT195\XLT19 3 DOOR BLACK GLASS 399X661 | 1 | PZ | | | | | | | | | | | | | | | | | | | | | | | | | | | | | | | | | | | | | | | | | | | | | | | | | |
| VT1086B0 | XLT195\XLT19 3 DOOR BLACK GLASS 399X661 | 1 | PZ | | | | | | | | | | | | | | | | | | | | | | | | | | | | | | | | | | | | | | | | | | | | | | | | | | | | | | |
| VM1022B | PROOFER DOOR UPPER BRACKET |  | KVM1022B | PROVER DOOR UPPER BRACKET | <table border="1"> <thead> <tr> <th>Code</th> <th>Description</th> <th>Qty</th> <th>UOM</th> </tr> </thead> <tbody> <tr> <td>VM1022B0</td> <td>PROOFER DOOR UPPER BRACKET</td> <td>1</td> <td>PZ</td> </tr> </tbody> </table> | Code | Description | Qty | UOM | VM1022B0 | PROOFER DOOR UPPER BRACKET | 1 | PZ | | | | | | | | | | | | | | | | | | | | | | | | | | | | | | | | | | | | | | | | | | | | |
| Code | Description | Qty | UOM | | | | | | | | | | | | | | | | | | | | | | | | | | | | | | | | | | | | | | | | | | | | | | | | | | | | | | |
| VM1022B0 | PROOFER DOOR UPPER BRACKET | 1 | PZ | | | | | | | | | | | | | | | | | | | | | | | | | | | | | | | | | | | | | | | | | | | | | | | | | | | | | | |

| COMPONENT | | | SPARE PART | | | | | | | | | | | | | | | | | | | | | | | | | | |
|--|---|--|------------|---|--|--------------------------------------|-------------|--------------------------------------|----------|-------------------------------------|---|-------------------------------------|----------|----------------------|--|----------------------|----------|----------------------------------|----------------------|----------------------------------|----------|----------------------------|----------------------------------|----------------------------|----|----------|----------------------------|---|----|
| Code | Description | Image | Code | Description | Components list | | | | | | | | | | | | | | | | | | | | | | | | |
| VM1023B | PROOFER DOOR RIGHT LOWER BRACKET |  | KVM1024A | PROOFER LF/RG DOOR LOWER BRACKET KIT | <table border="1"> <thead> <tr> <th>Code</th> <th>Description</th> <th>Qty</th> <th>UOM</th> </tr> </thead> <tbody> <tr> <td>VM1023A0</td> <td>PROOFER DOOR RIGHT LOWER BRACKET</td> <td>1</td> <td>PZ</td> </tr> <tr> <td>VM1024A0</td> <td>PROOFER DOOR LEFT LOWER BRACKET</td> <td>1</td> <td>PZ</td> </tr> </tbody> </table> | Code | Description | Qty | UOM | VM1023A0 | PROOFER DOOR RIGHT LOWER BRACKET | 1 | PZ | VM1024A0 | PROOFER DOOR LEFT LOWER BRACKET | 1 | PZ | | | | | | | | | | | | |
| | | | | | Code | Description | Qty | UOM | | | | | | | | | | | | | | | | | | | | | |
| VM1023A0 | PROOFER DOOR RIGHT LOWER BRACKET | 1 | PZ | | | | | | | | | | | | | | | | | | | | | | | | | | |
| VM1024A0 | PROOFER DOOR LEFT LOWER BRACKET | 1 | PZ | | | | | | | | | | | | | | | | | | | | | | | | | | |
| <table border="1"> <thead> <tr> <th>Code</th> <th>Description</th> <th>Qty</th> <th>UOM</th> </tr> </thead> <tbody> <tr> <td>CR1080A0</td> <td>XV-XL-XB ST. STEEL RIGHT HINGE</td> <td>1</td> <td>PZ</td> </tr> <tr> <td>CR1081A0</td> <td>XV-XL-XB ST. STEEL LEFT HINGE</td> <td>1</td> <td>PZ</td> </tr> <tr> <td>GN1320A1</td> <td>DOOR GLASS GASKET</td> <td>2</td> <td>PZ</td> </tr> <tr> <td>VI1685A0</td> <td>M6X6 STAINLESS STEEL SCREW</td> <td>4</td> <td>PZ</td> </tr> <tr> <td>VM1790A0</td> <td>HINGE BUSH 12X6.5 DI5.3</td> <td>2</td> <td>PZ</td> </tr> </tbody> </table> | Code | Description | Qty | UOM | CR1080A0 | XV-XL-XB ST. STEEL RIGHT HINGE | 1 | PZ | CR1081A0 | XV-XL-XB ST. STEEL LEFT HINGE | 1 | PZ | GN1320A1 | DOOR GLASS GASKET | 2 | PZ | VI1685A0 | M6X6 STAINLESS STEEL SCREW | 4 | PZ | VM1790A0 | HINGE BUSH 12X6.5 DI5.3 | 2 | PZ | | | | | |
| Code | Description | Qty | UOM | | | | | | | | | | | | | | | | | | | | | | | | | | |
| CR1080A0 | XV-XL-XB ST. STEEL RIGHT HINGE | 1 | PZ | | | | | | | | | | | | | | | | | | | | | | | | | | |
| CR1081A0 | XV-XL-XB ST. STEEL LEFT HINGE | 1 | PZ | | | | | | | | | | | | | | | | | | | | | | | | | | |
| GN1320A1 | DOOR GLASS GASKET | 2 | PZ | | | | | | | | | | | | | | | | | | | | | | | | | | |
| VI1685A0 | M6X6 STAINLESS STEEL SCREW | 4 | PZ | | | | | | | | | | | | | | | | | | | | | | | | | | |
| VM1790A0 | HINGE BUSH 12X6.5 DI5.3 | 2 | PZ | | | | | | | | | | | | | | | | | | | | | | | | | | |
| CR1081A | XV-XL-XB ST. STEEL LEFT HINGE |  | KCR1080A | RIGHT/LEFT HINGES KIT CR1080A+CR1081A | <table border="1"> <thead> <tr> <th>Code</th> <th>Description</th> <th>Qty</th> <th>UOM</th> </tr> </thead> <tbody> <tr> <td>CR1080A0</td> <td>XV-XL-XB ST. STEEL RIGHT HINGE</td> <td>1</td> <td>PZ</td> </tr> <tr> <td>CR1081A0</td> <td>XV-XL-XB ST. STEEL LEFT HINGE</td> <td>1</td> <td>PZ</td> </tr> <tr> <td>GN1320A1</td> <td>DOOR GLASS GASKET</td> <td>2</td> <td>PZ</td> </tr> <tr> <td>VI1685A0</td> <td>M6X6 STAINLESS STEEL SCREW</td> <td>4</td> <td>PZ</td> </tr> <tr> <td>VM1790A0</td> <td>HINGE BUSH 12X6.5 DI5.3</td> <td>2</td> <td>PZ</td> </tr> </tbody> </table> | Code | Description | Qty | UOM | CR1080A0 | XV-XL-XB ST. STEEL RIGHT HINGE | 1 | PZ | CR1081A0 | XV-XL-XB ST. STEEL LEFT HINGE | 1 | PZ | GN1320A1 | DOOR GLASS GASKET | 2 | PZ | VI1685A0 | M6X6 STAINLESS STEEL SCREW | 4 | PZ | VM1790A0 | HINGE BUSH 12X6.5 DI5.3 | 2 | PZ |
| Code | Description | Qty | UOM | | | | | | | | | | | | | | | | | | | | | | | | | | |
| CR1080A0 | XV-XL-XB ST. STEEL RIGHT HINGE | 1 | PZ | | | | | | | | | | | | | | | | | | | | | | | | | | |
| CR1081A0 | XV-XL-XB ST. STEEL LEFT HINGE | 1 | PZ | | | | | | | | | | | | | | | | | | | | | | | | | | |
| GN1320A1 | DOOR GLASS GASKET | 2 | PZ | | | | | | | | | | | | | | | | | | | | | | | | | | |
| VI1685A0 | M6X6 STAINLESS STEEL SCREW | 4 | PZ | | | | | | | | | | | | | | | | | | | | | | | | | | |
| VM1790A0 | HINGE BUSH 12X6.5 DI5.3 | 2 | PZ | | | | | | | | | | | | | | | | | | | | | | | | | | |
| GN1320A | DOOR GLASS HINGE GASKET |  | KGN1320A | DOOR GLASS SEAL 4 PCS. KIT | <table border="1"> <thead> <tr> <th>Code</th> <th>Description</th> <th>Qty</th> <th>UOM</th> </tr> </thead> <tbody> <tr> <td>GN1320A1</td> <td>DOOR GLASS GASKET</td> <td>4</td> <td>PZ</td> </tr> </tbody> </table> | Code | Description | Qty | UOM | GN1320A1 | DOOR GLASS GASKET | 4 | PZ | | | | | | | | | | | | | | | | |
| | | | | | Code | Description | Qty | UOM | | | | | | | | | | | | | | | | | | | | | |
| GN1320A1 | DOOR GLASS GASKET | 4 | PZ | | | | | | | | | | | | | | | | | | | | | | | | | | |
| KCR1080A | RIGHT/LEFT HINGES KIT CR1080A+CR1081A | <table border="1"> <thead> <tr> <th>Code</th> <th>Description</th> <th>Qty</th> <th>UOM</th> </tr> </thead> <tbody> <tr> <td>CR1080A0</td> <td>XV-XL-XB ST. STEEL RIGHT HINGE</td> <td>1</td> <td>PZ</td> </tr> <tr> <td>CR1081A0</td> <td>XV-XL-XB ST. STEEL LEFT HINGE</td> <td>1</td> <td>PZ</td> </tr> <tr> <td>GN1320A1</td> <td>DOOR GLASS GASKET</td> <td>2</td> <td>PZ</td> </tr> <tr> <td>VI1685A0</td> <td>M6X6 STAINLESS STEEL SCREW</td> <td>4</td> <td>PZ</td> </tr> <tr> <td>VM1790A0</td> <td>HINGE BUSH 12X6.5 DI5.3</td> <td>2</td> <td>PZ</td> </tr> </tbody> </table> | Code | Description | Qty | UOM | CR1080A0 | XV-XL-XB ST. STEEL RIGHT HINGE | 1 | PZ | CR1081A0 | XV-XL-XB ST. STEEL LEFT HINGE | 1 | PZ | GN1320A1 | DOOR GLASS GASKET | 2 | PZ | VI1685A0 | M6X6 STAINLESS STEEL SCREW | 4 | PZ | VM1790A0 | HINGE BUSH 12X6.5 DI5.3 | 2 | PZ | | | |
| Code | Description | Qty | UOM | | | | | | | | | | | | | | | | | | | | | | | | | | |
| CR1080A0 | XV-XL-XB ST. STEEL RIGHT HINGE | 1 | PZ | | | | | | | | | | | | | | | | | | | | | | | | | | |
| CR1081A0 | XV-XL-XB ST. STEEL LEFT HINGE | 1 | PZ | | | | | | | | | | | | | | | | | | | | | | | | | | |
| GN1320A1 | DOOR GLASS GASKET | 2 | PZ | | | | | | | | | | | | | | | | | | | | | | | | | | |
| VI1685A0 | M6X6 STAINLESS STEEL SCREW | 4 | PZ | | | | | | | | | | | | | | | | | | | | | | | | | | |
| VM1790A0 | HINGE BUSH 12X6.5 DI5.3 | 2 | PZ | | | | | | | | | | | | | | | | | | | | | | | | | | |
| CR1080A | XV-XL-XB ST. STEEL RIGHT HINGE |  | KCR1080A | RIGHT/LEFT HINGES KIT CR1080A+CR1081A | <table border="1"> <thead> <tr> <th>Code</th> <th>Description</th> <th>Qty</th> <th>UOM</th> </tr> </thead> <tbody> <tr> <td>CR1080A0</td> <td>XV-XL-XB ST. STEEL RIGHT HINGE</td> <td>1</td> <td>PZ</td> </tr> <tr> <td>CR1081A0</td> <td>XV-XL-XB ST. STEEL LEFT HINGE</td> <td>1</td> <td>PZ</td> </tr> <tr> <td>GN1320A1</td> <td>DOOR GLASS GASKET</td> <td>2</td> <td>PZ</td> </tr> </tbody> </table> | Code | Description | Qty | UOM | CR1080A0 | XV-XL-XB ST. STEEL RIGHT HINGE | 1 | PZ | CR1081A0 | XV-XL-XB ST. STEEL LEFT HINGE | 1 | PZ | GN1320A1 | DOOR GLASS GASKET | 2 | PZ | | | | | | | | |
| Code | Description | Qty | UOM | | | | | | | | | | | | | | | | | | | | | | | | | | |
| CR1080A0 | XV-XL-XB ST. STEEL RIGHT HINGE | 1 | PZ | | | | | | | | | | | | | | | | | | | | | | | | | | |
| CR1081A0 | XV-XL-XB ST. STEEL LEFT HINGE | 1 | PZ | | | | | | | | | | | | | | | | | | | | | | | | | | |
| GN1320A1 | DOOR GLASS GASKET | 2 | PZ | | | | | | | | | | | | | | | | | | | | | | | | | | |

| COMPONENT | | | SPARE PART | | | | | | | | | | | | | | | | | | | | | | | | | | | | | | | | | | |
|-----------|--|---|--------------------------|--|---|------|-------------|-----|-----|----------|--|---|----|----------|--------------------------------|-----|-----|----------|--|---|----|----------|-------------------------------------|---|----|----------|----------------------------|---|----|----------|----------------------------------|---|----|----------|----------------------------|---|----|
| Code | Description | Image | Code | Description | Components list | | | | | | | | | | | | | | | | | | | | | | | | | | | | | | | | |
| CR1080A | XV-XL-XB ST. STEEL RIGHT HINGE |  | KCR1080A | RIGHT/LEFT HINGES KIT CR1080A+CR1081A | <table border="1"> <thead> <tr> <th>Code</th> <th>Description</th> <th>Qty</th> <th>UOM</th> </tr> </thead> <tbody> <tr> <td>VI1685A0</td> <td>M6X6 STAINLESS STEEL SCREW</td> <td>4</td> <td>PZ</td> </tr> <tr> <td>VM1790A0</td> <td>HINGE BUSH 12X6.5 DI5.3</td> <td>2</td> <td>PZ</td> </tr> </tbody> </table> | Code | Description | Qty | UOM | VI1685A0 | M6X6 STAINLESS STEEL SCREW | 4 | PZ | VM1790A0 | HINGE BUSH 12X6.5 DI5.3 | 2 | PZ | | | | | | | | | | | | | | | | | | | | |
| Code | Description | Qty | UOM | | | | | | | | | | | | | | | | | | | | | | | | | | | | | | | | | | |
| VI1685A0 | M6X6 STAINLESS STEEL SCREW | 4 | PZ | | | | | | | | | | | | | | | | | | | | | | | | | | | | | | | | | | |
| VM1790A0 | HINGE BUSH 12X6.5 DI5.3 | 2 | PZ | | | | | | | | | | | | | | | | | | | | | | | | | | | | | | | | | | |
| GN1320A | DOOR GLASS HINGE GASKET |  | KGN1320A KCR1080A | DOOR GLASS SEAL 4 PCS. KIT RIGHT/LEFT HINGES KIT CR1080A+CR1081A | <table border="1"> <thead> <tr> <th>Code</th> <th>Description</th> <th>Qty</th> <th>UOM</th> </tr> </thead> <tbody> <tr> <td>GN1320A1</td> <td>DOOR GLASS HINGE GASKET</td> <td>4</td> <td>PZ</td> </tr> </tbody> </table> <table border="1"> <thead> <tr> <th>Code</th> <th>Description</th> <th>Qty</th> <th>UOM</th> </tr> </thead> <tbody> <tr> <td>CR1080A0</td> <td>XV-XL-XB ST. STEEL RIGHT HINGE</td> <td>1</td> <td>PZ</td> </tr> <tr> <td>CR1081A0</td> <td>XV-XL-XB ST. STEEL LEFT HINGE</td> <td>1</td> <td>PZ</td> </tr> <tr> <td>GN1320A1</td> <td>DOOR GLASS HINGE GASKET</td> <td>2</td> <td>PZ</td> </tr> <tr> <td>VI1685A0</td> <td>M6X6 STAINLESS STEEL SCREW</td> <td>4</td> <td>PZ</td> </tr> <tr> <td>VM1790A0</td> <td>HINGE BUSH 12X6.5 DI5.3</td> <td>2</td> <td>PZ</td> </tr> </tbody> </table> | Code | Description | Qty | UOM | GN1320A1 | DOOR GLASS HINGE GASKET | 4 | PZ | Code | Description | Qty | UOM | CR1080A0 | XV-XL-XB ST. STEEL RIGHT HINGE | 1 | PZ | CR1081A0 | XV-XL-XB ST. STEEL LEFT HINGE | 1 | PZ | GN1320A1 | DOOR GLASS HINGE GASKET | 2 | PZ | VI1685A0 | M6X6 STAINLESS STEEL SCREW | 4 | PZ | VM1790A0 | HINGE BUSH 12X6.5 DI5.3 | 2 | PZ |
| Code | Description | Qty | UOM | | | | | | | | | | | | | | | | | | | | | | | | | | | | | | | | | | |
| GN1320A1 | DOOR GLASS HINGE GASKET | 4 | PZ | | | | | | | | | | | | | | | | | | | | | | | | | | | | | | | | | | |
| Code | Description | Qty | UOM | | | | | | | | | | | | | | | | | | | | | | | | | | | | | | | | | | |
| CR1080A0 | XV-XL-XB ST. STEEL RIGHT HINGE | 1 | PZ | | | | | | | | | | | | | | | | | | | | | | | | | | | | | | | | | | |
| CR1081A0 | XV-XL-XB ST. STEEL LEFT HINGE | 1 | PZ | | | | | | | | | | | | | | | | | | | | | | | | | | | | | | | | | | |
| GN1320A1 | DOOR GLASS HINGE GASKET | 2 | PZ | | | | | | | | | | | | | | | | | | | | | | | | | | | | | | | | | | |
| VI1685A0 | M6X6 STAINLESS STEEL SCREW | 4 | PZ | | | | | | | | | | | | | | | | | | | | | | | | | | | | | | | | | | |
| VM1790A0 | HINGE BUSH 12X6.5 DI5.3 | 2 | PZ | | | | | | | | | | | | | | | | | | | | | | | | | | | | | | | | | | |
| MG1015B | L.MISS/L.MICRO/CH EFTOP HANDLE END |  | KMG1015B | 2 PCS. HANDLE END KIT | <table border="1"> <thead> <tr> <th>Code</th> <th>Description</th> <th>Qty</th> <th>UOM</th> </tr> </thead> <tbody> <tr> <td>MG1015B0</td> <td>L.MISS/L.MICR O/CHEFTOP HANDLE END</td> <td>2</td> <td>PZ</td> </tr> <tr> <td>VI1855A0</td> <td>5X25 SELF-TAPPIN G SCREW</td> <td>2</td> <td>PZ</td> </tr> <tr> <td>VI1870A0</td> <td>50X50 SELF-THREADI NG SCREW FOR PLASTIC</td> <td>2</td> <td>PZ</td> </tr> <tr> <td>VM1025A0</td> <td>Ø16 GREY NYLON LID</td> <td>2</td> <td>PZ</td> </tr> </tbody> </table> | Code | Description | Qty | UOM | MG1015B0 | L.MISS/L.MICR O/CHEFTOP HANDLE END | 2 | PZ | VI1855A0 | 5X25 SELF-TAPPIN G SCREW | 2 | PZ | VI1870A0 | 50X50 SELF-THREADI NG SCREW FOR PLASTIC | 2 | PZ | VM1025A0 | Ø16 GREY NYLON LID | 2 | PZ | | | | | | | | | | | | |
| Code | Description | Qty | UOM | | | | | | | | | | | | | | | | | | | | | | | | | | | | | | | | | | |
| MG1015B0 | L.MISS/L.MICR O/CHEFTOP HANDLE END | 2 | PZ | | | | | | | | | | | | | | | | | | | | | | | | | | | | | | | | | | |
| VI1855A0 | 5X25 SELF-TAPPIN G SCREW | 2 | PZ | | | | | | | | | | | | | | | | | | | | | | | | | | | | | | | | | | |
| VI1870A0 | 50X50 SELF-THREADI NG SCREW FOR PLASTIC | 2 | PZ | | | | | | | | | | | | | | | | | | | | | | | | | | | | | | | | | | |
| VM1025A0 | Ø16 GREY NYLON LID | 2 | PZ | | | | | | | | | | | | | | | | | | | | | | | | | | | | | | | | | | |
| VM1720A | XL405 DOOR WASKER |  | VM1720A0 | XL405 DOOR WASKER | | | | | | | | | | | | | | | | | | | | | | | | | | | | | | | | | |



| COMPONENT | | | SPARE PART | | | | | | | | | | | | | | | | | | | | | | | | | | | | | | | | | | | | | | | | | | | | | | | | | | | | | | |
|-----------|---|---|------------|---|---|------|-------------|-----|-----|----------|---|---|----|----------|--------------------------------------|---|----|----------|-------------------------------------|---|----|----------|----------------------|---|----|----------|----------------------------------|---|----|----------|--|---|----|----------|---|---|----|----------|----------------------------------|---|----|----------|---------------------------------|---|----|----------|----------------------|---|----|----------|---|---|----|----------|---|---|----|
| Code | Description | Image | Code | Description | Components list | | | | | | | | | | | | | | | | | | | | | | | | | | | | | | | | | | | | | | | | | | | | | | | | | | | | |
| TB1077A | XLT135/XLT195 Ø18X1 HANDLE TUB |  | KTB1077A | XLT135/XLT195 HANDLE TUBE KIT | <table border="1"> <thead> <tr> <th>Code</th> <th>Description</th> <th>Qty</th> <th>UOM</th> </tr> </thead> <tbody> <tr> <td>TB1077A0</td> <td>XLT135/XLT195 5 Ø18X1 HANDLE TUBE</td> <td>1</td> <td>PZ</td> </tr> <tr> <td>VI1220A1</td> <td>4,2X12 TCB SELF-TAPPIN G SCREW</td> <td>4</td> <td>PZ</td> </tr> <tr> <td>VM1794A0</td> <td>250X4.8 PA66 BLACK CLAMP</td> <td>2</td> <td>PZ</td> </tr> <tr> <td>VM2103A0</td> <td>CLAMP LOCK</td> <td>2</td> <td>PZ</td> </tr> </tbody> </table> | Code | Description | Qty | UOM | TB1077A0 | XLT135/XLT195 5 Ø18X1 HANDLE TUBE | 1 | PZ | VI1220A1 | 4,2X12 TCB SELF-TAPPIN G SCREW | 4 | PZ | VM1794A0 | 250X4.8 PA66 BLACK CLAMP | 2 | PZ | VM2103A0 | CLAMP LOCK | 2 | PZ | | | | | | | | | | | | | | | | | | | | | | | | | | | | | | | | |
| Code | Description | Qty | UOM | | | | | | | | | | | | | | | | | | | | | | | | | | | | | | | | | | | | | | | | | | | | | | | | | | | | | | |
| TB1077A0 | XLT135/XLT195 5 Ø18X1 HANDLE TUBE | 1 | PZ | | | | | | | | | | | | | | | | | | | | | | | | | | | | | | | | | | | | | | | | | | | | | | | | | | | | | | |
| VI1220A1 | 4,2X12 TCB SELF-TAPPIN G SCREW | 4 | PZ | | | | | | | | | | | | | | | | | | | | | | | | | | | | | | | | | | | | | | | | | | | | | | | | | | | | | | |
| VM1794A0 | 250X4.8 PA66 BLACK CLAMP | 2 | PZ | | | | | | | | | | | | | | | | | | | | | | | | | | | | | | | | | | | | | | | | | | | | | | | | | | | | | | |
| VM2103A0 | CLAMP LOCK | 2 | PZ | | | | | | | | | | | | | | | | | | | | | | | | | | | | | | | | | | | | | | | | | | | | | | | | | | | | | | |
| 0H4540A | DOOR PLATES MAGNET XL405 |  | 0H4540A0 | DOOR PLATES MAGNET XL405 | | | | | | | | | | | | | | | | | | | | | | | | | | | | | | | | | | | | | | | | | | | | | | | | | | | | | |
| GN1330A | FERRITIC PLATE GASKET XL405 |  | KVT1086BR | XLT195/XLT193 RIGHT COMPLETE DOOR KIT | <table border="1"> <thead> <tr> <th>Code</th> <th>Description</th> <th>Qty</th> <th>UOM</th> </tr> </thead> <tbody> <tr> <td>0H4540A0</td> <td>DOOR PLATES MAGNET XL40</td> <td>1</td> <td>PZ</td> </tr> <tr> <td>CR1080A0</td> <td>XV-XL-XB ST. STEEL RIGHT HINGE</td> <td>1</td> <td>PZ</td> </tr> <tr> <td>CR1081A0</td> <td>XV-XL-XB ST. STEEL LEFT HINGE</td> <td>1</td> <td>PZ</td> </tr> <tr> <td>GN1320A1</td> <td>DOOR GLASS GASKET</td> <td>2</td> <td>PZ</td> </tr> <tr> <td>GN1330A0</td> <td>FERRITIC PLATE GASKET XL40</td> <td>1</td> <td>PZ</td> </tr> <tr> <td>MG1015B0</td> <td>L.MISS/L.MICR O/CHEFTOP HANDLE END</td> <td>2</td> <td>PZ</td> </tr> <tr> <td>TB1077A0</td> <td>XLT135/XLT195 5 Ø18X1 HANDLE TUBE</td> <td>1</td> <td>PZ</td> </tr> <tr> <td>VI1685A0</td> <td>M6X6 STAINLESS STEEL SCREW</td> <td>4</td> <td>PZ</td> </tr> <tr> <td>VI1930A0</td> <td>5X25 ST. STEEL SCREW CHIP</td> <td>2</td> <td>PZ</td> </tr> <tr> <td>VM1720A0</td> <td>XL405 DOOR WASKER</td> <td>1</td> <td>PZ</td> </tr> <tr> <td>VT1086B0</td> <td>XLT195/XLT195 3 DOOR BLACK GLASS 399X661</td> <td>1</td> <td>PZ</td> </tr> <tr> <td>VT1086B0</td> <td>XLT195/XLT195 3 DOOR BLACK GLASS 399X661</td> <td>1</td> <td>PZ</td> </tr> </tbody> </table> | Code | Description | Qty | UOM | 0H4540A0 | DOOR PLATES MAGNET XL40 | 1 | PZ | CR1080A0 | XV-XL-XB ST. STEEL RIGHT HINGE | 1 | PZ | CR1081A0 | XV-XL-XB ST. STEEL LEFT HINGE | 1 | PZ | GN1320A1 | DOOR GLASS GASKET | 2 | PZ | GN1330A0 | FERRITIC PLATE GASKET XL40 | 1 | PZ | MG1015B0 | L.MISS/L.MICR O/CHEFTOP HANDLE END | 2 | PZ | TB1077A0 | XLT135/XLT195 5 Ø18X1 HANDLE TUBE | 1 | PZ | VI1685A0 | M6X6 STAINLESS STEEL SCREW | 4 | PZ | VI1930A0 | 5X25 ST. STEEL SCREW CHIP | 2 | PZ | VM1720A0 | XL405 DOOR WASKER | 1 | PZ | VT1086B0 | XLT195/XLT195 3 DOOR BLACK GLASS 399X661 | 1 | PZ | VT1086B0 | XLT195/XLT195 3 DOOR BLACK GLASS 399X661 | 1 | PZ |
| Code | Description | Qty | UOM | | | | | | | | | | | | | | | | | | | | | | | | | | | | | | | | | | | | | | | | | | | | | | | | | | | | | | |
| 0H4540A0 | DOOR PLATES MAGNET XL40 | 1 | PZ | | | | | | | | | | | | | | | | | | | | | | | | | | | | | | | | | | | | | | | | | | | | | | | | | | | | | | |
| CR1080A0 | XV-XL-XB ST. STEEL RIGHT HINGE | 1 | PZ | | | | | | | | | | | | | | | | | | | | | | | | | | | | | | | | | | | | | | | | | | | | | | | | | | | | | | |
| CR1081A0 | XV-XL-XB ST. STEEL LEFT HINGE | 1 | PZ | | | | | | | | | | | | | | | | | | | | | | | | | | | | | | | | | | | | | | | | | | | | | | | | | | | | | | |
| GN1320A1 | DOOR GLASS GASKET | 2 | PZ | | | | | | | | | | | | | | | | | | | | | | | | | | | | | | | | | | | | | | | | | | | | | | | | | | | | | | |
| GN1330A0 | FERRITIC PLATE GASKET XL40 | 1 | PZ | | | | | | | | | | | | | | | | | | | | | | | | | | | | | | | | | | | | | | | | | | | | | | | | | | | | | | |
| MG1015B0 | L.MISS/L.MICR O/CHEFTOP HANDLE END | 2 | PZ | | | | | | | | | | | | | | | | | | | | | | | | | | | | | | | | | | | | | | | | | | | | | | | | | | | | | | |
| TB1077A0 | XLT135/XLT195 5 Ø18X1 HANDLE TUBE | 1 | PZ | | | | | | | | | | | | | | | | | | | | | | | | | | | | | | | | | | | | | | | | | | | | | | | | | | | | | | |
| VI1685A0 | M6X6 STAINLESS STEEL SCREW | 4 | PZ | | | | | | | | | | | | | | | | | | | | | | | | | | | | | | | | | | | | | | | | | | | | | | | | | | | | | | |
| VI1930A0 | 5X25 ST. STEEL SCREW CHIP | 2 | PZ | | | | | | | | | | | | | | | | | | | | | | | | | | | | | | | | | | | | | | | | | | | | | | | | | | | | | | |
| VM1720A0 | XL405 DOOR WASKER | 1 | PZ | | | | | | | | | | | | | | | | | | | | | | | | | | | | | | | | | | | | | | | | | | | | | | | | | | | | | | |
| VT1086B0 | XLT195/XLT195 3 DOOR BLACK GLASS 399X661 | 1 | PZ | | | | | | | | | | | | | | | | | | | | | | | | | | | | | | | | | | | | | | | | | | | | | | | | | | | | | | |
| VT1086B0 | XLT195/XLT195 3 DOOR BLACK GLASS 399X661 | 1 | PZ | | | | | | | | | | | | | | | | | | | | | | | | | | | | | | | | | | | | | | | | | | | | | | | | | | | | | | |

| COMPONENT | | | SPARE PART | | | | | | | | | | | | | | | | | | | | | | | | | | | | | | | | | | | | | | | | | | | | | | | | | | | | | | | | | | | | | | | | | | | | | | | | | | | | | | | | | | | | | |
|-----------|--|---|------------|--|--|------|-------------|-----|-----|----------|----------------------------|---|----|----------|--------------------------------------|---|----|----------|-------------------------------------|---|----|----------|----------------------|---|----|----------|----------------------------------|---|----|----------|--|---|----|----------|--|---|----|----------|----------------------------------|---|----|----------|---------------------------------|---|----|----------|----------------------|---|----|----------|--|---|----|----------|--|---|----|-----------|---|--|------|-------------|-----|-----|----------|----------------------------|---|----|----------|--------------------------------------|---|----|----------|-------------------------------------|---|----|----------|----------------------|---|----|----------|----------------------------------|---|----|----------|--|-------|---|
| Code | Description | Image | Code | Description | Components list | | | | | | | | | | | | | | | | | | | | | | | | | | | | | | | | | | | | | | | | | | | | | | | | | | | | | | | | | | | | | | | | | | | | | | | | | | | | | | | | | | | |
| GN1330A | FERRITIC PLATE GASKET XL405 |  | KVT1086BL | XLT195/XLT193 LEFT COMPLETE DOOR KIT | <table border="1"> <thead> <tr> <th>Code</th> <th>Description</th> <th>Qty</th> <th>UOM</th> </tr> </thead> <tbody> <tr> <td>0H4540A0</td> <td>DOOR PLATES MAGNET XL40</td> <td>1</td> <td>PZ</td> </tr> <tr> <td>CR1080A0</td> <td>XV-XL-XB ST. STEEL RIGHT HINGE</td> <td>1</td> <td>PZ</td> </tr> <tr> <td>CR1081A0</td> <td>XV-XL-XB ST. STEEL LEFT HINGE</td> <td>1</td> <td>PZ</td> </tr> <tr> <td>GN1320A1</td> <td>DOOR GLASS GASKET</td> <td>2</td> <td>PZ</td> </tr> <tr> <td>GN1330A0</td> <td>FERRITIC PLATE GASKET XL40</td> <td>1</td> <td>PZ</td> </tr> <tr> <td>MG1015B0</td> <td>L.MISS/L.MICR O/CHEFTOP HANDLE END</td> <td>2</td> <td>PZ</td> </tr> <tr> <td>TB1077A0</td> <td>XLT135/XLT19 5 Ø18X1 HANDLE TUBE</td> <td>1</td> <td>PZ</td> </tr> <tr> <td>VI1685A0</td> <td>M6X6 STAINLESS STEEL SCREW</td> <td>4</td> <td>PZ</td> </tr> <tr> <td>VI1930A0</td> <td>5X25 ST. STEEL SCREW CHIP</td> <td>2</td> <td>PZ</td> </tr> <tr> <td>VM1720A0</td> <td>XL405 DOOR WASKER</td> <td>1</td> <td>PZ</td> </tr> <tr> <td>VT1086B0</td> <td>XLT195/XLT19 3 DOOR BLACK GLASS 399X661</td> <td>1</td> <td>PZ</td> </tr> <tr> <td>VT1086B0</td> <td>XLT195/XLT19 3 DOOR BLACK GLASS 399X661</td> <td>1</td> <td>PZ</td> </tr> </tbody> </table> | Code | Description | Qty | UOM | 0H4540A0 | DOOR PLATES MAGNET XL40 | 1 | PZ | CR1080A0 | XV-XL-XB ST. STEEL RIGHT HINGE | 1 | PZ | CR1081A0 | XV-XL-XB ST. STEEL LEFT HINGE | 1 | PZ | GN1320A1 | DOOR GLASS GASKET | 2 | PZ | GN1330A0 | FERRITIC PLATE GASKET XL40 | 1 | PZ | MG1015B0 | L.MISS/L.MICR O/CHEFTOP HANDLE END | 2 | PZ | TB1077A0 | XLT135/XLT19 5 Ø18X1 HANDLE TUBE | 1 | PZ | VI1685A0 | M6X6 STAINLESS STEEL SCREW | 4 | PZ | VI1930A0 | 5X25 ST. STEEL SCREW CHIP | 2 | PZ | VM1720A0 | XL405 DOOR WASKER | 1 | PZ | VT1086B0 | XLT195/XLT19 3 DOOR BLACK GLASS 399X661 | 1 | PZ | VT1086B0 | XLT195/XLT19 3 DOOR BLACK GLASS 399X661 | 1 | PZ | KVT1076BR | XLT135/XLT133 RIGHT COMPLETE DOOR KIT | <table border="1"> <thead> <tr> <th>Code</th> <th>Description</th> <th>Qty</th> <th>UOM</th> </tr> </thead> <tbody> <tr> <td>0H4540A0</td> <td>DOOR PLATES MAGNET XL40</td> <td>1</td> <td>PZ</td> </tr> <tr> <td>CR1080A0</td> <td>XV-XL-XB ST. STEEL RIGHT HINGE</td> <td>1</td> <td>PZ</td> </tr> <tr> <td>CR1081A0</td> <td>XV-XL-XB ST. STEEL LEFT HINGE</td> <td>1</td> <td>PZ</td> </tr> <tr> <td>GN1320A1</td> <td>DOOR GLASS GASKET</td> <td>2</td> <td>PZ</td> </tr> <tr> <td>GN1330A0</td> <td>FERRITIC PLATE GASKET XL40</td> <td>1</td> <td>PZ</td> </tr> <tr> <td>IP1385A1</td> <td>CORNER POLYSTYREN E PACKING 110X80X2000</td> <td>1.400</td> <td>M</td> </tr> </tbody> </table> | Code | Description | Qty | UOM | 0H4540A0 | DOOR PLATES MAGNET XL40 | 1 | PZ | CR1080A0 | XV-XL-XB ST. STEEL RIGHT HINGE | 1 | PZ | CR1081A0 | XV-XL-XB ST. STEEL LEFT HINGE | 1 | PZ | GN1320A1 | DOOR GLASS GASKET | 2 | PZ | GN1330A0 | FERRITIC PLATE GASKET XL40 | 1 | PZ | IP1385A1 | CORNER POLYSTYREN E PACKING 110X80X2000 | 1.400 | M |
| | | | Code | Description | Qty | UOM | | | | | | | | | | | | | | | | | | | | | | | | | | | | | | | | | | | | | | | | | | | | | | | | | | | | | | | | | | | | | | | | | | | | | | | | | | | | | | | | | | |
| 0H4540A0 | DOOR PLATES MAGNET XL40 | 1 | PZ | | | | | | | | | | | | | | | | | | | | | | | | | | | | | | | | | | | | | | | | | | | | | | | | | | | | | | | | | | | | | | | | | | | | | | | | | | | | | | | | | | | | | |
| CR1080A0 | XV-XL-XB ST. STEEL RIGHT HINGE | 1 | PZ | | | | | | | | | | | | | | | | | | | | | | | | | | | | | | | | | | | | | | | | | | | | | | | | | | | | | | | | | | | | | | | | | | | | | | | | | | | | | | | | | | | | | |
| CR1081A0 | XV-XL-XB ST. STEEL LEFT HINGE | 1 | PZ | | | | | | | | | | | | | | | | | | | | | | | | | | | | | | | | | | | | | | | | | | | | | | | | | | | | | | | | | | | | | | | | | | | | | | | | | | | | | | | | | | | | | |
| GN1320A1 | DOOR GLASS GASKET | 2 | PZ | | | | | | | | | | | | | | | | | | | | | | | | | | | | | | | | | | | | | | | | | | | | | | | | | | | | | | | | | | | | | | | | | | | | | | | | | | | | | | | | | | | | | |
| GN1330A0 | FERRITIC PLATE GASKET XL40 | 1 | PZ | | | | | | | | | | | | | | | | | | | | | | | | | | | | | | | | | | | | | | | | | | | | | | | | | | | | | | | | | | | | | | | | | | | | | | | | | | | | | | | | | | | | | |
| MG1015B0 | L.MISS/L.MICR O/CHEFTOP HANDLE END | 2 | PZ | | | | | | | | | | | | | | | | | | | | | | | | | | | | | | | | | | | | | | | | | | | | | | | | | | | | | | | | | | | | | | | | | | | | | | | | | | | | | | | | | | | | | |
| TB1077A0 | XLT135/XLT19 5 Ø18X1 HANDLE TUBE | 1 | PZ | | | | | | | | | | | | | | | | | | | | | | | | | | | | | | | | | | | | | | | | | | | | | | | | | | | | | | | | | | | | | | | | | | | | | | | | | | | | | | | | | | | | | |
| VI1685A0 | M6X6 STAINLESS STEEL SCREW | 4 | PZ | | | | | | | | | | | | | | | | | | | | | | | | | | | | | | | | | | | | | | | | | | | | | | | | | | | | | | | | | | | | | | | | | | | | | | | | | | | | | | | | | | | | | |
| VI1930A0 | 5X25 ST. STEEL SCREW CHIP | 2 | PZ | | | | | | | | | | | | | | | | | | | | | | | | | | | | | | | | | | | | | | | | | | | | | | | | | | | | | | | | | | | | | | | | | | | | | | | | | | | | | | | | | | | | | |
| VM1720A0 | XL405 DOOR WASKER | 1 | PZ | | | | | | | | | | | | | | | | | | | | | | | | | | | | | | | | | | | | | | | | | | | | | | | | | | | | | | | | | | | | | | | | | | | | | | | | | | | | | | | | | | | | | |
| VT1086B0 | XLT195/XLT19 3 DOOR BLACK GLASS 399X661 | 1 | PZ | | | | | | | | | | | | | | | | | | | | | | | | | | | | | | | | | | | | | | | | | | | | | | | | | | | | | | | | | | | | | | | | | | | | | | | | | | | | | | | | | | | | | |
| VT1086B0 | XLT195/XLT19 3 DOOR BLACK GLASS 399X661 | 1 | PZ | | | | | | | | | | | | | | | | | | | | | | | | | | | | | | | | | | | | | | | | | | | | | | | | | | | | | | | | | | | | | | | | | | | | | | | | | | | | | | | | | | | | | |
| Code | Description | Qty | UOM | | | | | | | | | | | | | | | | | | | | | | | | | | | | | | | | | | | | | | | | | | | | | | | | | | | | | | | | | | | | | | | | | | | | | | | | | | | | | | | | | | | | | |
| 0H4540A0 | DOOR PLATES MAGNET XL40 | 1 | PZ | | | | | | | | | | | | | | | | | | | | | | | | | | | | | | | | | | | | | | | | | | | | | | | | | | | | | | | | | | | | | | | | | | | | | | | | | | | | | | | | | | | | | |
| CR1080A0 | XV-XL-XB ST. STEEL RIGHT HINGE | 1 | PZ | | | | | | | | | | | | | | | | | | | | | | | | | | | | | | | | | | | | | | | | | | | | | | | | | | | | | | | | | | | | | | | | | | | | | | | | | | | | | | | | | | | | | |
| CR1081A0 | XV-XL-XB ST. STEEL LEFT HINGE | 1 | PZ | | | | | | | | | | | | | | | | | | | | | | | | | | | | | | | | | | | | | | | | | | | | | | | | | | | | | | | | | | | | | | | | | | | | | | | | | | | | | | | | | | | | | |
| GN1320A1 | DOOR GLASS GASKET | 2 | PZ | | | | | | | | | | | | | | | | | | | | | | | | | | | | | | | | | | | | | | | | | | | | | | | | | | | | | | | | | | | | | | | | | | | | | | | | | | | | | | | | | | | | | |
| GN1330A0 | FERRITIC PLATE GASKET XL40 | 1 | PZ | | | | | | | | | | | | | | | | | | | | | | | | | | | | | | | | | | | | | | | | | | | | | | | | | | | | | | | | | | | | | | | | | | | | | | | | | | | | | | | | | | | | | |
| IP1385A1 | CORNER POLYSTYREN E PACKING 110X80X2000 | 1.400 | M | | | | | | | | | | | | | | | | | | | | | | | | | | | | | | | | | | | | | | | | | | | | | | | | | | | | | | | | | | | | | | | | | | | | | | | | | | | | | | | | | | | | | |

| COMPONENT | | | SPARE PART | | | | | | | | | | | | | | | | | | | | | | | | | | | | | | | | | | | | | | | | | | |
|-----------|---|---|------------|---|--|------|-------------|----------------------------|-----|----------|---|--------------------------------------|---|----------|--|-------------------------------------|----|----------|--|----------------------|----|----------|----------------------------------|----------------------------------|----|----------|---------------------------------|--|-------|----------|--------------------------|---|-------|----------|----------------------|--|----|----------|--|---|----|----------|--|---|----|
| Code | Description | Image | Code | Description | Components list | | | | | | | | | | | | | | | | | | | | | | | | | | | | | | | | | | | | | | | | |
| GN1330A | FERRITIC PLATE GASKET XL405 |  | KVT1076BR | XLT135/XLT133 RIGHT COMPLETE DOOR KIT | <table border="1"> <thead> <tr> <th>Code</th> <th>Description</th> <th>Qty</th> <th>UOM</th> </tr> </thead> <tbody> <tr> <td>IP1508A1</td> <td>POLYSTYREN E U SHAPED PROFILE 2000X60X60</td> <td>0.300</td> <td>M</td> </tr> <tr> <td>MG1015B0</td> <td>L.MISS/L.MICR O/CHEFTOP HANDLE END</td> <td>2</td> <td>PZ</td> </tr> <tr> <td>TB1077A0</td> <td>XLT135/XLT19 5 Ø18X1 HANDLE TUBE</td> <td>1</td> <td>PZ</td> </tr> <tr> <td>VI1685A0</td> <td>M6X6 STAINLESS STEEL SCREW</td> <td>4</td> <td>PZ</td> </tr> <tr> <td>VI1930A0</td> <td>5X25 ST. STEEL SCREW CHIP</td> <td>2</td> <td>PZ</td> </tr> <tr> <td>VM1059A1</td> <td>HEAT SHRINK FILM H800</td> <td>1.500</td> <td>M</td> </tr> <tr> <td>VM1720A0</td> <td>XL405 DOOR WASKER</td> <td>1</td> <td>PZ</td> </tr> <tr> <td>VT1076B0</td> <td>XLT135/XLT13 3 BLACK DOOR GLASS 299X661</td> <td>1</td> <td>PZ</td> </tr> <tr> <td>VT1076B0</td> <td>XLT135/XLT13 3 BLACK DOOR GLASS 299X661</td> <td>1</td> <td>PZ</td> </tr> </tbody> </table> | Code | Description | Qty | UOM | IP1508A1 | POLYSTYREN E U SHAPED PROFILE 2000X60X60 | 0.300 | M | MG1015B0 | L.MISS/L.MICR O/CHEFTOP HANDLE END | 2 | PZ | TB1077A0 | XLT135/XLT19 5 Ø18X1 HANDLE TUBE | 1 | PZ | VI1685A0 | M6X6 STAINLESS STEEL SCREW | 4 | PZ | VI1930A0 | 5X25 ST. STEEL SCREW CHIP | 2 | PZ | VM1059A1 | HEAT SHRINK FILM H800 | 1.500 | M | VM1720A0 | XL405 DOOR WASKER | 1 | PZ | VT1076B0 | XLT135/XLT13 3 BLACK DOOR GLASS 299X661 | 1 | PZ | VT1076B0 | XLT135/XLT13 3 BLACK DOOR GLASS 299X661 | 1 | PZ |
| | | | Code | Description | Qty | UOM | | | | | | | | | | | | | | | | | | | | | | | | | | | | | | | | | | | | | | | |
| IP1508A1 | POLYSTYREN E U SHAPED PROFILE 2000X60X60 | 0.300 | M | | | | | | | | | | | | | | | | | | | | | | | | | | | | | | | | | | | | | | | | | | |
| MG1015B0 | L.MISS/L.MICR O/CHEFTOP HANDLE END | 2 | PZ | | | | | | | | | | | | | | | | | | | | | | | | | | | | | | | | | | | | | | | | | | |
| TB1077A0 | XLT135/XLT19 5 Ø18X1 HANDLE TUBE | 1 | PZ | | | | | | | | | | | | | | | | | | | | | | | | | | | | | | | | | | | | | | | | | | |
| VI1685A0 | M6X6 STAINLESS STEEL SCREW | 4 | PZ | | | | | | | | | | | | | | | | | | | | | | | | | | | | | | | | | | | | | | | | | | |
| VI1930A0 | 5X25 ST. STEEL SCREW CHIP | 2 | PZ | | | | | | | | | | | | | | | | | | | | | | | | | | | | | | | | | | | | | | | | | | |
| VM1059A1 | HEAT SHRINK FILM H800 | 1.500 | M | | | | | | | | | | | | | | | | | | | | | | | | | | | | | | | | | | | | | | | | | | |
| VM1720A0 | XL405 DOOR WASKER | 1 | PZ | | | | | | | | | | | | | | | | | | | | | | | | | | | | | | | | | | | | | | | | | | |
| VT1076B0 | XLT135/XLT13 3 BLACK DOOR GLASS 299X661 | 1 | PZ | | | | | | | | | | | | | | | | | | | | | | | | | | | | | | | | | | | | | | | | | | |
| VT1076B0 | XLT135/XLT13 3 BLACK DOOR GLASS 299X661 | 1 | PZ | | | | | | | | | | | | | | | | | | | | | | | | | | | | | | | | | | | | | | | | | | |
| KVT1076BL | XLT135/XLT133 LEFT COMPLETE DOOR KIT | <table border="1"> <thead> <tr> <th>Code</th> <th>Description</th> <th>Qty</th> <th>UOM</th> </tr> </thead> <tbody> <tr> <td>0H4540A0</td> <td>DOOR PLATES MAGNET XL40</td> <td>1</td> <td>PZ</td> </tr> <tr> <td>CR1080A0</td> <td>XV-XL-XB ST. STEEL RIGHT HINGE</td> <td>1</td> <td>PZ</td> </tr> <tr> <td>CR1081A0</td> <td>XV-XL-XB ST. STEEL LEFT HINGE</td> <td>1</td> <td>PZ</td> </tr> <tr> <td>GN1320A1</td> <td>DOOR GLASS GASKET</td> <td>2</td> <td>PZ</td> </tr> <tr> <td>GN1330A0</td> <td>FERRITIC PLATE GASKET XL40</td> <td>1</td> <td>PZ</td> </tr> <tr> <td>IP1385A1</td> <td>CORNER POLYSTYREN E PACKING 110X80X2000</td> <td>1.400</td> <td>M</td> </tr> <tr> <td>IP1508A1</td> <td>POLYSTYREN E U SHAPED PROFILE 2000X60X60</td> <td>0.300</td> <td>M</td> </tr> <tr> <td>MG1015B0</td> <td>L.MISS/L.MICR O/CHEFTOP HANDLE END</td> <td>2</td> <td>PZ</td> </tr> </tbody> </table> | Code | Description | Qty | UOM | 0H4540A0 | DOOR PLATES MAGNET XL40 | 1 | PZ | CR1080A0 | XV-XL-XB ST. STEEL RIGHT HINGE | 1 | PZ | CR1081A0 | XV-XL-XB ST. STEEL LEFT HINGE | 1 | PZ | GN1320A1 | DOOR GLASS GASKET | 2 | PZ | GN1330A0 | FERRITIC PLATE GASKET XL40 | 1 | PZ | IP1385A1 | CORNER POLYSTYREN E PACKING 110X80X2000 | 1.400 | M | IP1508A1 | POLYSTYREN E U SHAPED PROFILE 2000X60X60 | 0.300 | M | MG1015B0 | L.MISS/L.MICR O/CHEFTOP HANDLE END | 2 | PZ | | | | | | | |
| Code | Description | Qty | UOM | | | | | | | | | | | | | | | | | | | | | | | | | | | | | | | | | | | | | | | | | | |
| 0H4540A0 | DOOR PLATES MAGNET XL40 | 1 | PZ | | | | | | | | | | | | | | | | | | | | | | | | | | | | | | | | | | | | | | | | | | |
| CR1080A0 | XV-XL-XB ST. STEEL RIGHT HINGE | 1 | PZ | | | | | | | | | | | | | | | | | | | | | | | | | | | | | | | | | | | | | | | | | | |
| CR1081A0 | XV-XL-XB ST. STEEL LEFT HINGE | 1 | PZ | | | | | | | | | | | | | | | | | | | | | | | | | | | | | | | | | | | | | | | | | | |
| GN1320A1 | DOOR GLASS GASKET | 2 | PZ | | | | | | | | | | | | | | | | | | | | | | | | | | | | | | | | | | | | | | | | | | |
| GN1330A0 | FERRITIC PLATE GASKET XL40 | 1 | PZ | | | | | | | | | | | | | | | | | | | | | | | | | | | | | | | | | | | | | | | | | | |
| IP1385A1 | CORNER POLYSTYREN E PACKING 110X80X2000 | 1.400 | M | | | | | | | | | | | | | | | | | | | | | | | | | | | | | | | | | | | | | | | | | | |
| IP1508A1 | POLYSTYREN E U SHAPED PROFILE 2000X60X60 | 0.300 | M | | | | | | | | | | | | | | | | | | | | | | | | | | | | | | | | | | | | | | | | | | |
| MG1015B0 | L.MISS/L.MICR O/CHEFTOP HANDLE END | 2 | PZ | | | | | | | | | | | | | | | | | | | | | | | | | | | | | | | | | | | | | | | | | | |

| COMPONENT | | | SPARE PART | | | | | | | | | | | | | | | | | | | | | | | | | | | | | | | | | | | | | | | | | | | | | | | |
|-----------|---|--|------------|--|---|------|-------------|--------------------------------------|-----|----------|--|----------------------------|----|----------|----------------------------------|--------------------------------------|----|----------|---------------------------------|-------------------------------------|----|----------|--------------------------|----------------------|---|----------|----------------------|----------------------------------|----|----------|--|--|-------|----------|--|---|-------|---|----------|--|---|----|----------|------------------------------|---|----|----------|----------------------------------|---|----|
| Code | Description | Image | Code | Description | Components list | | | | | | | | | | | | | | | | | | | | | | | | | | | | | | | | | | | | | | | | | | | | | |
| GN1330A | FERRITIC PLATE GASKET XL405 |  | KVT1076BL | XLT135/XLT133 LEFT COMPLETE DOOR KIT | <table border="1"> <thead> <tr> <th>Code</th> <th>Description</th> <th>Qty</th> <th>UOM</th> </tr> </thead> <tbody> <tr> <td>TB1077A0</td> <td>XLT135/XLT19 5 Ø18X1 HANDLE TUBE</td> <td>1</td> <td>PZ</td> </tr> <tr> <td>VI1685A0</td> <td>M6X6 STAINLESS STEEL SCREW</td> <td>4</td> <td>PZ</td> </tr> <tr> <td>VI1930A0</td> <td>5X25 ST. STEEL SCREW CHIP</td> <td>2</td> <td>PZ</td> </tr> <tr> <td>VM1059A1</td> <td>HEAT SHRINK FILM H800</td> <td>1.500</td> <td>M</td> </tr> <tr> <td>VM1720A0</td> <td>XL405 DOOR WASKER</td> <td>1</td> <td>PZ</td> </tr> <tr> <td>VT1076B0</td> <td>XLT135/XLT13 3 BLACK DOOR GLASS 299X661</td> <td>1</td> <td>PZ</td> </tr> <tr> <td>VT1076B0</td> <td>XLT135/XLT13 3 BLACK DOOR GLASS 299X661</td> <td>1</td> <td>PZ</td> </tr> </tbody> </table> | Code | Description | Qty | UOM | TB1077A0 | XLT135/XLT19 5 Ø18X1 HANDLE TUBE | 1 | PZ | VI1685A0 | M6X6 STAINLESS STEEL SCREW | 4 | PZ | VI1930A0 | 5X25 ST. STEEL SCREW CHIP | 2 | PZ | VM1059A1 | HEAT SHRINK FILM H800 | 1.500 | M | VM1720A0 | XL405 DOOR WASKER | 1 | PZ | VT1076B0 | XLT135/XLT13 3 BLACK DOOR GLASS 299X661 | 1 | PZ | VT1076B0 | XLT135/XLT13 3 BLACK DOOR GLASS 299X661 | 1 | PZ | | | | | | | | | | | | | |
| | | | Code | Description | Qty | UOM | | | | | | | | | | | | | | | | | | | | | | | | | | | | | | | | | | | | | | | | | | | | |
| TB1077A0 | XLT135/XLT19 5 Ø18X1 HANDLE TUBE | 1 | PZ | | | | | | | | | | | | | | | | | | | | | | | | | | | | | | | | | | | | | | | | | | | | | | | |
| VI1685A0 | M6X6 STAINLESS STEEL SCREW | 4 | PZ | | | | | | | | | | | | | | | | | | | | | | | | | | | | | | | | | | | | | | | | | | | | | | | |
| VI1930A0 | 5X25 ST. STEEL SCREW CHIP | 2 | PZ | | | | | | | | | | | | | | | | | | | | | | | | | | | | | | | | | | | | | | | | | | | | | | | |
| VM1059A1 | HEAT SHRINK FILM H800 | 1.500 | M | | | | | | | | | | | | | | | | | | | | | | | | | | | | | | | | | | | | | | | | | | | | | | | |
| VM1720A0 | XL405 DOOR WASKER | 1 | PZ | | | | | | | | | | | | | | | | | | | | | | | | | | | | | | | | | | | | | | | | | | | | | | | |
| VT1076B0 | XLT135/XLT13 3 BLACK DOOR GLASS 299X661 | 1 | PZ | | | | | | | | | | | | | | | | | | | | | | | | | | | | | | | | | | | | | | | | | | | | | | | |
| VT1076B0 | XLT135/XLT13 3 BLACK DOOR GLASS 299X661 | 1 | PZ | | | | | | | | | | | | | | | | | | | | | | | | | | | | | | | | | | | | | | | | | | | | | | | |
| KDR1210AR | XL405 COMPLETE RIGHT DOOR | <table border="1"> <thead> <tr> <th>Code</th> <th>Description</th> <th>Qty</th> <th>UOM</th> </tr> </thead> <tbody> <tr> <td>0H4530C0</td> <td>RIGHT DOOR DRIPPING TRAY XL415</td> <td>1</td> <td>PZ</td> </tr> <tr> <td>0H4540A0</td> <td>DOOR PLATES MAGNET XL40</td> <td>1</td> <td>PZ</td> </tr> <tr> <td>CR1080A0</td> <td>XV-XL-XB ST. STEEL RIGHT HINGE</td> <td>1</td> <td>PZ</td> </tr> <tr> <td>CR1081A0</td> <td>XV-XL-XB ST. STEEL LEFT HINGE</td> <td>1</td> <td>PZ</td> </tr> <tr> <td>GN1320A1</td> <td>DOOR GLASS GASKET</td> <td>2</td> <td>PZ</td> </tr> <tr> <td>GN1330A0</td> <td>FERRITIC PLATE GASKET XL40</td> <td>1</td> <td>PZ</td> </tr> <tr> <td>IP1385A1</td> <td>CORNER POLYSTYREN E PACKING 110X80X2000</td> <td>1.300</td> <td>M</td> </tr> <tr> <td>IP1508A1</td> <td>POLYSTYREN E U SHAPED PROFILE 2000X60X60</td> <td>0.570</td> <td>M</td> </tr> <tr> <td>MG1015B0</td> <td>L.MISS/L.MICR O/CHEFTOP HANDLE END</td> <td>2</td> <td>PZ</td> </tr> <tr> <td>TB1730A0</td> <td>XL405-413-415 HANDLE TUBE</td> <td>1</td> <td>PZ</td> </tr> <tr> <td>VI1685A0</td> <td>M6X6 STAINLESS STEEL SCREW</td> <td>4</td> <td>PZ</td> </tr> </tbody> </table> | Code | Description | Qty | UOM | 0H4530C0 | RIGHT DOOR DRIPPING TRAY XL415 | 1 | PZ | 0H4540A0 | DOOR PLATES MAGNET XL40 | 1 | PZ | CR1080A0 | XV-XL-XB ST. STEEL RIGHT HINGE | 1 | PZ | CR1081A0 | XV-XL-XB ST. STEEL LEFT HINGE | 1 | PZ | GN1320A1 | DOOR GLASS GASKET | 2 | PZ | GN1330A0 | FERRITIC PLATE GASKET XL40 | 1 | PZ | IP1385A1 | CORNER POLYSTYREN E PACKING 110X80X2000 | 1.300 | M | IP1508A1 | POLYSTYREN E U SHAPED PROFILE 2000X60X60 | 0.570 | M | MG1015B0 | L.MISS/L.MICR O/CHEFTOP HANDLE END | 2 | PZ | TB1730A0 | XL405-413-415 HANDLE TUBE | 1 | PZ | VI1685A0 | M6X6 STAINLESS STEEL SCREW | 4 | PZ |
| Code | Description | Qty | UOM | | | | | | | | | | | | | | | | | | | | | | | | | | | | | | | | | | | | | | | | | | | | | | | |
| 0H4530C0 | RIGHT DOOR DRIPPING TRAY XL415 | 1 | PZ | | | | | | | | | | | | | | | | | | | | | | | | | | | | | | | | | | | | | | | | | | | | | | | |
| 0H4540A0 | DOOR PLATES MAGNET XL40 | 1 | PZ | | | | | | | | | | | | | | | | | | | | | | | | | | | | | | | | | | | | | | | | | | | | | | | |
| CR1080A0 | XV-XL-XB ST. STEEL RIGHT HINGE | 1 | PZ | | | | | | | | | | | | | | | | | | | | | | | | | | | | | | | | | | | | | | | | | | | | | | | |
| CR1081A0 | XV-XL-XB ST. STEEL LEFT HINGE | 1 | PZ | | | | | | | | | | | | | | | | | | | | | | | | | | | | | | | | | | | | | | | | | | | | | | | |
| GN1320A1 | DOOR GLASS GASKET | 2 | PZ | | | | | | | | | | | | | | | | | | | | | | | | | | | | | | | | | | | | | | | | | | | | | | | |
| GN1330A0 | FERRITIC PLATE GASKET XL40 | 1 | PZ | | | | | | | | | | | | | | | | | | | | | | | | | | | | | | | | | | | | | | | | | | | | | | | |
| IP1385A1 | CORNER POLYSTYREN E PACKING 110X80X2000 | 1.300 | M | | | | | | | | | | | | | | | | | | | | | | | | | | | | | | | | | | | | | | | | | | | | | | | |
| IP1508A1 | POLYSTYREN E U SHAPED PROFILE 2000X60X60 | 0.570 | M | | | | | | | | | | | | | | | | | | | | | | | | | | | | | | | | | | | | | | | | | | | | | | | |
| MG1015B0 | L.MISS/L.MICR O/CHEFTOP HANDLE END | 2 | PZ | | | | | | | | | | | | | | | | | | | | | | | | | | | | | | | | | | | | | | | | | | | | | | | |
| TB1730A0 | XL405-413-415 HANDLE TUBE | 1 | PZ | | | | | | | | | | | | | | | | | | | | | | | | | | | | | | | | | | | | | | | | | | | | | | | |
| VI1685A0 | M6X6 STAINLESS STEEL SCREW | 4 | PZ | | | | | | | | | | | | | | | | | | | | | | | | | | | | | | | | | | | | | | | | | | | | | | | |

| COMPONENT | | | SPARE PART | | | | | | | | | | | | | | | | | | | | | | | | | | | | | | | | | | | | | | | | | | | | | | | | | | | | | | | | | | | | | | | |
|-----------|---|--|------------|------------------------------|--|------|-------------|-------------------------------------|-----|----------|---------------------------------|----------------------------|----|----------|--------------------------|--------------------------------------|---|----------|----------------------|-------------------------------------|----|----------|----------------------------|----------------------|----|----------|-----------------------------|----------------------------------|----|----------|-----------------------------|--|-------|---|----------|---|-------|---|----------|--|---|----|----------|------------------------------|---|----|----------|----------------------------------|---|----|----------|---------------------------------|---|----|----------|--------------------------|-------|---|----------|----------------------|---|----|----------|----------------------------|---|----|
| Code | Description | Image | Code | Description | Components list | | | | | | | | | | | | | | | | | | | | | | | | | | | | | | | | | | | | | | | | | | | | | | | | | | | | | | | | | | | | | |
| GN1330A | FERRITIC PLATE GASKET XL405 |  | KDR1210AR | XL405 COMPLETE RIGHT DOOR | <table border="1"> <thead> <tr> <th>Code</th> <th>Description</th> <th>Qty</th> <th>UOM</th> </tr> </thead> <tbody> <tr> <td>VI1930A0</td> <td>5X25 ST. STEEL SCREW CHIP</td> <td>2</td> <td>PZ</td> </tr> <tr> <td>VM1059A1</td> <td>HEAT SHRINK FILM H800</td> <td>1.300</td> <td>M</td> </tr> <tr> <td>VM1720A0</td> <td>XL405 DOOR WASKER</td> <td>1</td> <td>PZ</td> </tr> <tr> <td>VM1790A0</td> <td>HINGE BUSH 12X6.5 DI5.3</td> <td>2</td> <td>PZ</td> </tr> <tr> <td>VT1210A0</td> <td>XL405-413-415 DOOR GLASS</td> <td>1</td> <td>PZ</td> </tr> <tr> <td>VT1210A0</td> <td>XL405-413-415 DOOR GLASS</td> <td>1</td> <td>PZ</td> </tr> </tbody> </table> | Code | Description | Qty | UOM | VI1930A0 | 5X25 ST. STEEL SCREW CHIP | 2 | PZ | VM1059A1 | HEAT SHRINK FILM H800 | 1.300 | M | VM1720A0 | XL405 DOOR WASKER | 1 | PZ | VM1790A0 | HINGE BUSH 12X6.5 DI5.3 | 2 | PZ | VT1210A0 | XL405-413-415 DOOR GLASS | 1 | PZ | VT1210A0 | XL405-413-415 DOOR GLASS | 1 | PZ | | | | | | | | | | | | | | | | | | | | | | | | | | | | | | | | | |
| | | | Code | Description | Qty | UOM | | | | | | | | | | | | | | | | | | | | | | | | | | | | | | | | | | | | | | | | | | | | | | | | | | | | | | | | | | | | |
| VI1930A0 | 5X25 ST. STEEL SCREW CHIP | 2 | PZ | | | | | | | | | | | | | | | | | | | | | | | | | | | | | | | | | | | | | | | | | | | | | | | | | | | | | | | | | | | | | | | |
| VM1059A1 | HEAT SHRINK FILM H800 | 1.300 | M | | | | | | | | | | | | | | | | | | | | | | | | | | | | | | | | | | | | | | | | | | | | | | | | | | | | | | | | | | | | | | | |
| VM1720A0 | XL405 DOOR WASKER | 1 | PZ | | | | | | | | | | | | | | | | | | | | | | | | | | | | | | | | | | | | | | | | | | | | | | | | | | | | | | | | | | | | | | | |
| VM1790A0 | HINGE BUSH 12X6.5 DI5.3 | 2 | PZ | | | | | | | | | | | | | | | | | | | | | | | | | | | | | | | | | | | | | | | | | | | | | | | | | | | | | | | | | | | | | | | |
| VT1210A0 | XL405-413-415 DOOR GLASS | 1 | PZ | | | | | | | | | | | | | | | | | | | | | | | | | | | | | | | | | | | | | | | | | | | | | | | | | | | | | | | | | | | | | | | |
| VT1210A0 | XL405-413-415 DOOR GLASS | 1 | PZ | | | | | | | | | | | | | | | | | | | | | | | | | | | | | | | | | | | | | | | | | | | | | | | | | | | | | | | | | | | | | | | |
| KDR1210AL | XL405 COMPLETE LEFT DOOR | <table border="1"> <thead> <tr> <th>Code</th> <th>Description</th> <th>Qty</th> <th>UOM</th> </tr> </thead> <tbody> <tr> <td>0H4535C0</td> <td>LEFT DOOR DRIPPING TRAY XL415</td> <td>1</td> <td>PZ</td> </tr> <tr> <td>0H4540A0</td> <td>DOOR PLATES MAGNET XL40</td> <td>1</td> <td>PZ</td> </tr> <tr> <td>CR1080A0</td> <td>XV-XL-XB ST. STEEL RIGHT HINGE</td> <td>1</td> <td>PZ</td> </tr> <tr> <td>CR1081A0</td> <td>XV-XL-XB ST. STEEL LEFT HINGE</td> <td>1</td> <td>PZ</td> </tr> <tr> <td>GN1320A1</td> <td>DOOR GLASS GASKET</td> <td>2</td> <td>PZ</td> </tr> <tr> <td>GN1330A0</td> <td>FERRITIC PLATE GASKET XL40</td> <td>1</td> <td>PZ</td> </tr> <tr> <td>IP1385A1</td> <td>CORNER POLYSTYREN E PACKING 110X80X2000</td> <td>1.300</td> <td>M</td> </tr> <tr> <td>IP1508A1</td> <td>POLYSTYREN E U SHAPED PROFILE 2000X60X60</td> <td>0.570</td> <td>M</td> </tr> <tr> <td>MG1015B0</td> <td>L.MISS/L.MICR O/CHEFTOP HANDLE END</td> <td>2</td> <td>PZ</td> </tr> <tr> <td>TB1730A0</td> <td>XL405-413-415 HANDLE TUBE</td> <td>1</td> <td>PZ</td> </tr> <tr> <td>VI1685A0</td> <td>M6X6 STAINLESS STEEL SCREW</td> <td>4</td> <td>PZ</td> </tr> <tr> <td>VI1930A0</td> <td>5X25 ST. STEEL SCREW CHIP</td> <td>2</td> <td>PZ</td> </tr> <tr> <td>VM1059A1</td> <td>HEAT SHRINK FILM H800</td> <td>1.300</td> <td>M</td> </tr> <tr> <td>VM1720A0</td> <td>XL405 DOOR WASKER</td> <td>1</td> <td>PZ</td> </tr> <tr> <td>VM1790A0</td> <td>HINGE BUSH 12X6.5 DI5.3</td> <td>2</td> <td>PZ</td> </tr> </tbody> </table> | Code | Description | Qty | UOM | 0H4535C0 | LEFT DOOR DRIPPING TRAY XL415 | 1 | PZ | 0H4540A0 | DOOR PLATES MAGNET XL40 | 1 | PZ | CR1080A0 | XV-XL-XB ST. STEEL RIGHT HINGE | 1 | PZ | CR1081A0 | XV-XL-XB ST. STEEL LEFT HINGE | 1 | PZ | GN1320A1 | DOOR GLASS GASKET | 2 | PZ | GN1330A0 | FERRITIC PLATE GASKET XL40 | 1 | PZ | IP1385A1 | CORNER POLYSTYREN E PACKING 110X80X2000 | 1.300 | M | IP1508A1 | POLYSTYREN E U SHAPED PROFILE 2000X60X60 | 0.570 | M | MG1015B0 | L.MISS/L.MICR O/CHEFTOP HANDLE END | 2 | PZ | TB1730A0 | XL405-413-415 HANDLE TUBE | 1 | PZ | VI1685A0 | M6X6 STAINLESS STEEL SCREW | 4 | PZ | VI1930A0 | 5X25 ST. STEEL SCREW CHIP | 2 | PZ | VM1059A1 | HEAT SHRINK FILM H800 | 1.300 | M | VM1720A0 | XL405 DOOR WASKER | 1 | PZ | VM1790A0 | HINGE BUSH 12X6.5 DI5.3 | 2 | PZ |
| Code | Description | Qty | UOM | | | | | | | | | | | | | | | | | | | | | | | | | | | | | | | | | | | | | | | | | | | | | | | | | | | | | | | | | | | | | | | |
| 0H4535C0 | LEFT DOOR DRIPPING TRAY XL415 | 1 | PZ | | | | | | | | | | | | | | | | | | | | | | | | | | | | | | | | | | | | | | | | | | | | | | | | | | | | | | | | | | | | | | | |
| 0H4540A0 | DOOR PLATES MAGNET XL40 | 1 | PZ | | | | | | | | | | | | | | | | | | | | | | | | | | | | | | | | | | | | | | | | | | | | | | | | | | | | | | | | | | | | | | | |
| CR1080A0 | XV-XL-XB ST. STEEL RIGHT HINGE | 1 | PZ | | | | | | | | | | | | | | | | | | | | | | | | | | | | | | | | | | | | | | | | | | | | | | | | | | | | | | | | | | | | | | | |
| CR1081A0 | XV-XL-XB ST. STEEL LEFT HINGE | 1 | PZ | | | | | | | | | | | | | | | | | | | | | | | | | | | | | | | | | | | | | | | | | | | | | | | | | | | | | | | | | | | | | | | |
| GN1320A1 | DOOR GLASS GASKET | 2 | PZ | | | | | | | | | | | | | | | | | | | | | | | | | | | | | | | | | | | | | | | | | | | | | | | | | | | | | | | | | | | | | | | |
| GN1330A0 | FERRITIC PLATE GASKET XL40 | 1 | PZ | | | | | | | | | | | | | | | | | | | | | | | | | | | | | | | | | | | | | | | | | | | | | | | | | | | | | | | | | | | | | | | |
| IP1385A1 | CORNER POLYSTYREN E PACKING 110X80X2000 | 1.300 | M | | | | | | | | | | | | | | | | | | | | | | | | | | | | | | | | | | | | | | | | | | | | | | | | | | | | | | | | | | | | | | | |
| IP1508A1 | POLYSTYREN E U SHAPED PROFILE 2000X60X60 | 0.570 | M | | | | | | | | | | | | | | | | | | | | | | | | | | | | | | | | | | | | | | | | | | | | | | | | | | | | | | | | | | | | | | | |
| MG1015B0 | L.MISS/L.MICR O/CHEFTOP HANDLE END | 2 | PZ | | | | | | | | | | | | | | | | | | | | | | | | | | | | | | | | | | | | | | | | | | | | | | | | | | | | | | | | | | | | | | | |
| TB1730A0 | XL405-413-415 HANDLE TUBE | 1 | PZ | | | | | | | | | | | | | | | | | | | | | | | | | | | | | | | | | | | | | | | | | | | | | | | | | | | | | | | | | | | | | | | |
| VI1685A0 | M6X6 STAINLESS STEEL SCREW | 4 | PZ | | | | | | | | | | | | | | | | | | | | | | | | | | | | | | | | | | | | | | | | | | | | | | | | | | | | | | | | | | | | | | | |
| VI1930A0 | 5X25 ST. STEEL SCREW CHIP | 2 | PZ | | | | | | | | | | | | | | | | | | | | | | | | | | | | | | | | | | | | | | | | | | | | | | | | | | | | | | | | | | | | | | | |
| VM1059A1 | HEAT SHRINK FILM H800 | 1.300 | M | | | | | | | | | | | | | | | | | | | | | | | | | | | | | | | | | | | | | | | | | | | | | | | | | | | | | | | | | | | | | | | |
| VM1720A0 | XL405 DOOR WASKER | 1 | PZ | | | | | | | | | | | | | | | | | | | | | | | | | | | | | | | | | | | | | | | | | | | | | | | | | | | | | | | | | | | | | | | |
| VM1790A0 | HINGE BUSH 12X6.5 DI5.3 | 2 | PZ | | | | | | | | | | | | | | | | | | | | | | | | | | | | | | | | | | | | | | | | | | | | | | | | | | | | | | | | | | | | | | | |

| COMPONENT | | | SPARE PART | | | | | | | | | | | | | | | | | | | | | | | | | | | | | | | | | | | | | | | | | | | | | | | | | | | | | | | | | | | | | | | | | | | | | | | | | |
|-----------|--|---|------------|---|--|------|-------------|-----|-----|----------|-----------------------------|---|----|----------|--------------------------------------|---|----|----------|-------------------------------------|---|----|----------|----------------------|---|----|----------|----------------------------------|---|----|----------|--|---|----|----------|--|---|----|----------|----------------------------------|---|----|----------|---------------------------------|---|----|----------|----------------------|---|----|----------|--|---|----|----------|--|---|----|-----------|--|---|------|-------------|-----|-----|----------|----------------------------|---|----|----------|--------------------------------------|---|----|----------|-------------------------------------|---|----|
| Code | Description | Image | Code | Description | Components list | | | | | | | | | | | | | | | | | | | | | | | | | | | | | | | | | | | | | | | | | | | | | | | | | | | | | | | | | | | | | | | | | | | | | | | |
| GN1330A | FERRITIC PLATE GASKET XL405 |  | KDR1210AL | XL405 COMPLETE LEFT DOOR | <table border="1"> <thead> <tr> <th>Code</th> <th>Description</th> <th>Qty</th> <th>UOM</th> </tr> </thead> <tbody> <tr> <td>VT1210A0</td> <td>XL405-413-415 DOOR GLASS</td> <td>1</td> <td>PZ</td> </tr> <tr> <td>VT1210A0</td> <td>XL405-413-415 DOOR GLASS</td> <td>1</td> <td>PZ</td> </tr> </tbody> </table> | Code | Description | Qty | UOM | VT1210A0 | XL405-413-415 DOOR GLASS | 1 | PZ | VT1210A0 | XL405-413-415 DOOR GLASS | 1 | PZ | | | | | | | | | | | | | | | | | | | | | | | | | | | | | | | | | | | | | | | | | | | | | | | | | | | | | | | | | | | |
| Code | Description | Qty | UOM | | | | | | | | | | | | | | | | | | | | | | | | | | | | | | | | | | | | | | | | | | | | | | | | | | | | | | | | | | | | | | | | | | | | | | | | | |
| VT1210A0 | XL405-413-415 DOOR GLASS | 1 | PZ | | | | | | | | | | | | | | | | | | | | | | | | | | | | | | | | | | | | | | | | | | | | | | | | | | | | | | | | | | | | | | | | | | | | | | | | | |
| VT1210A0 | XL405-413-415 DOOR GLASS | 1 | PZ | | | | | | | | | | | | | | | | | | | | | | | | | | | | | | | | | | | | | | | | | | | | | | | | | | | | | | | | | | | | | | | | | | | | | | | | | |
| VT1086B | XLT195\XLT193 DOOR BLACK GLASS 399X661 |  | KVT1086BR | XLT195/XLT193 RIGHT COMPLETE DOOR KIT | <table border="1"> <thead> <tr> <th>Code</th> <th>Description</th> <th>Qty</th> <th>UOM</th> </tr> </thead> <tbody> <tr> <td>0H4540A0</td> <td>DOOR PLATES MAGNET XL40</td> <td>1</td> <td>PZ</td> </tr> <tr> <td>CR1080A0</td> <td>XV-XL-XB ST. STEEL RIGHT HINGE</td> <td>1</td> <td>PZ</td> </tr> <tr> <td>CR1081A0</td> <td>XV-XL-XB ST. STEEL LEFT HINGE</td> <td>1</td> <td>PZ</td> </tr> <tr> <td>GN1320A1</td> <td>DOOR GLASS GASKET</td> <td>2</td> <td>PZ</td> </tr> <tr> <td>GN1330A0</td> <td>FERRITIC PLATE GASKET XL40</td> <td>1</td> <td>PZ</td> </tr> <tr> <td>MG1015B0</td> <td>L.MISS/L.MICR O/CHEFTOP HANDLE END</td> <td>2</td> <td>PZ</td> </tr> <tr> <td>TB1077A0</td> <td>XLT135/XLT19 5 Ø18X1 HANDLE TUBE</td> <td>1</td> <td>PZ</td> </tr> <tr> <td>VI1685A0</td> <td>M6X6 STAINLESS STEEL SCREW</td> <td>4</td> <td>PZ</td> </tr> <tr> <td>VI1930A0</td> <td>5X25 ST. STEEL SCREW CHIP</td> <td>2</td> <td>PZ</td> </tr> <tr> <td>VM1720A0</td> <td>XL405 DOOR WASKER</td> <td>1</td> <td>PZ</td> </tr> <tr> <td>VT1086B0</td> <td>XLT195\XLT19 3 DOOR BLACK GLASS 399X661</td> <td>1</td> <td>PZ</td> </tr> <tr> <td>VT1086B0</td> <td>XLT195\XLT19 3 DOOR BLACK GLASS 399X661</td> <td>1</td> <td>PZ</td> </tr> </tbody> </table> | Code | Description | Qty | UOM | 0H4540A0 | DOOR PLATES MAGNET XL40 | 1 | PZ | CR1080A0 | XV-XL-XB ST. STEEL RIGHT HINGE | 1 | PZ | CR1081A0 | XV-XL-XB ST. STEEL LEFT HINGE | 1 | PZ | GN1320A1 | DOOR GLASS GASKET | 2 | PZ | GN1330A0 | FERRITIC PLATE GASKET XL40 | 1 | PZ | MG1015B0 | L.MISS/L.MICR O/CHEFTOP HANDLE END | 2 | PZ | TB1077A0 | XLT135/XLT19 5 Ø18X1 HANDLE TUBE | 1 | PZ | VI1685A0 | M6X6 STAINLESS STEEL SCREW | 4 | PZ | VI1930A0 | 5X25 ST. STEEL SCREW CHIP | 2 | PZ | VM1720A0 | XL405 DOOR WASKER | 1 | PZ | VT1086B0 | XLT195\XLT19 3 DOOR BLACK GLASS 399X661 | 1 | PZ | VT1086B0 | XLT195\XLT19 3 DOOR BLACK GLASS 399X661 | 1 | PZ | KVT1086BL | XLT195/XLT193 LEFT COMPLETE DOOR KIT | <table border="1"> <thead> <tr> <th>Code</th> <th>Description</th> <th>Qty</th> <th>UOM</th> </tr> </thead> <tbody> <tr> <td>0H4540A0</td> <td>DOOR PLATES MAGNET XL40</td> <td>1</td> <td>PZ</td> </tr> <tr> <td>CR1080A0</td> <td>XV-XL-XB ST. STEEL RIGHT HINGE</td> <td>1</td> <td>PZ</td> </tr> <tr> <td>CR1081A0</td> <td>XV-XL-XB ST. STEEL LEFT HINGE</td> <td>1</td> <td>PZ</td> </tr> </tbody> </table> | Code | Description | Qty | UOM | 0H4540A0 | DOOR PLATES MAGNET XL40 | 1 | PZ | CR1080A0 | XV-XL-XB ST. STEEL RIGHT HINGE | 1 | PZ | CR1081A0 | XV-XL-XB ST. STEEL LEFT HINGE | 1 | PZ |
| Code | Description | Qty | UOM | | | | | | | | | | | | | | | | | | | | | | | | | | | | | | | | | | | | | | | | | | | | | | | | | | | | | | | | | | | | | | | | | | | | | | | | | |
| 0H4540A0 | DOOR PLATES MAGNET XL40 | 1 | PZ | | | | | | | | | | | | | | | | | | | | | | | | | | | | | | | | | | | | | | | | | | | | | | | | | | | | | | | | | | | | | | | | | | | | | | | | | |
| CR1080A0 | XV-XL-XB ST. STEEL RIGHT HINGE | 1 | PZ | | | | | | | | | | | | | | | | | | | | | | | | | | | | | | | | | | | | | | | | | | | | | | | | | | | | | | | | | | | | | | | | | | | | | | | | | |
| CR1081A0 | XV-XL-XB ST. STEEL LEFT HINGE | 1 | PZ | | | | | | | | | | | | | | | | | | | | | | | | | | | | | | | | | | | | | | | | | | | | | | | | | | | | | | | | | | | | | | | | | | | | | | | | | |
| GN1320A1 | DOOR GLASS GASKET | 2 | PZ | | | | | | | | | | | | | | | | | | | | | | | | | | | | | | | | | | | | | | | | | | | | | | | | | | | | | | | | | | | | | | | | | | | | | | | | | |
| GN1330A0 | FERRITIC PLATE GASKET XL40 | 1 | PZ | | | | | | | | | | | | | | | | | | | | | | | | | | | | | | | | | | | | | | | | | | | | | | | | | | | | | | | | | | | | | | | | | | | | | | | | | |
| MG1015B0 | L.MISS/L.MICR O/CHEFTOP HANDLE END | 2 | PZ | | | | | | | | | | | | | | | | | | | | | | | | | | | | | | | | | | | | | | | | | | | | | | | | | | | | | | | | | | | | | | | | | | | | | | | | | |
| TB1077A0 | XLT135/XLT19 5 Ø18X1 HANDLE TUBE | 1 | PZ | | | | | | | | | | | | | | | | | | | | | | | | | | | | | | | | | | | | | | | | | | | | | | | | | | | | | | | | | | | | | | | | | | | | | | | | | |
| VI1685A0 | M6X6 STAINLESS STEEL SCREW | 4 | PZ | | | | | | | | | | | | | | | | | | | | | | | | | | | | | | | | | | | | | | | | | | | | | | | | | | | | | | | | | | | | | | | | | | | | | | | | | |
| VI1930A0 | 5X25 ST. STEEL SCREW CHIP | 2 | PZ | | | | | | | | | | | | | | | | | | | | | | | | | | | | | | | | | | | | | | | | | | | | | | | | | | | | | | | | | | | | | | | | | | | | | | | | | |
| VM1720A0 | XL405 DOOR WASKER | 1 | PZ | | | | | | | | | | | | | | | | | | | | | | | | | | | | | | | | | | | | | | | | | | | | | | | | | | | | | | | | | | | | | | | | | | | | | | | | | |
| VT1086B0 | XLT195\XLT19 3 DOOR BLACK GLASS 399X661 | 1 | PZ | | | | | | | | | | | | | | | | | | | | | | | | | | | | | | | | | | | | | | | | | | | | | | | | | | | | | | | | | | | | | | | | | | | | | | | | | |
| VT1086B0 | XLT195\XLT19 3 DOOR BLACK GLASS 399X661 | 1 | PZ | | | | | | | | | | | | | | | | | | | | | | | | | | | | | | | | | | | | | | | | | | | | | | | | | | | | | | | | | | | | | | | | | | | | | | | | | |
| Code | Description | Qty | UOM | | | | | | | | | | | | | | | | | | | | | | | | | | | | | | | | | | | | | | | | | | | | | | | | | | | | | | | | | | | | | | | | | | | | | | | | | |
| 0H4540A0 | DOOR PLATES MAGNET XL40 | 1 | PZ | | | | | | | | | | | | | | | | | | | | | | | | | | | | | | | | | | | | | | | | | | | | | | | | | | | | | | | | | | | | | | | | | | | | | | | | | |
| CR1080A0 | XV-XL-XB ST. STEEL RIGHT HINGE | 1 | PZ | | | | | | | | | | | | | | | | | | | | | | | | | | | | | | | | | | | | | | | | | | | | | | | | | | | | | | | | | | | | | | | | | | | | | | | | | |
| CR1081A0 | XV-XL-XB ST. STEEL LEFT HINGE | 1 | PZ | | | | | | | | | | | | | | | | | | | | | | | | | | | | | | | | | | | | | | | | | | | | | | | | | | | | | | | | | | | | | | | | | | | | | | | | | |



| COMPONENT | | | SPARE PART | | | | | | | | | | | | | | | | | | | | | | | | | | | | | | | | | | | | | | | | | | |
|-----------|--|---|------------|--|--|------|-------------|-----|-----|----------|----------------------|---|----|----------|----------------------------------|---|----|----------|--|---|----|----------|--|---|----|----------|----------------------------------|---|----|----------|---------------------------------|---|----|----------|----------------------|---|----|----------|--|---|----|----------|--|---|----|
| Code | Description | Image | Code | Description | Components list | | | | | | | | | | | | | | | | | | | | | | | | | | | | | | | | | | | | | | | | |
| VT1086B | XLT195\XLT193 DOOR BLACK GLASS 399X661 |  | KVT1086BL | XLT195/XLT193 LEFT COMPLETE DOOR KIT | <table border="1"> <thead> <tr> <th>Code</th> <th>Description</th> <th>Qty</th> <th>UOM</th> </tr> </thead> <tbody> <tr> <td>GN1320A1</td> <td>DOOR GLASS GASKET</td> <td>2</td> <td>PZ</td> </tr> <tr> <td>GN1330A0</td> <td>FERRITIC PLATE GASKET XL40</td> <td>1</td> <td>PZ</td> </tr> <tr> <td>MG1015B0</td> <td>L.MISS/L.MICR O/CHEFTOP HANDLE END</td> <td>2</td> <td>PZ</td> </tr> <tr> <td>TB1077A0</td> <td>XLT135/XLT19 5 Ø18X1 HANDLE TUBE</td> <td>1</td> <td>PZ</td> </tr> <tr> <td>VI1685A0</td> <td>M6X6 STAINLESS STEEL SCREW</td> <td>4</td> <td>PZ</td> </tr> <tr> <td>VI1930A0</td> <td>5X25 ST. STEEL SCREW CHIP</td> <td>2</td> <td>PZ</td> </tr> <tr> <td>VM1720A0</td> <td>XL405 DOOR WASKER</td> <td>1</td> <td>PZ</td> </tr> <tr> <td>VT1086B0</td> <td>XLT195\XLT19 3 DOOR BLACK GLASS 399X661</td> <td>1</td> <td>PZ</td> </tr> <tr> <td>VT1086B0</td> <td>XLT195\XLT19 3 DOOR BLACK GLASS 399X661</td> <td>1</td> <td>PZ</td> </tr> </tbody> </table> | Code | Description | Qty | UOM | GN1320A1 | DOOR GLASS GASKET | 2 | PZ | GN1330A0 | FERRITIC PLATE GASKET XL40 | 1 | PZ | MG1015B0 | L.MISS/L.MICR O/CHEFTOP HANDLE END | 2 | PZ | TB1077A0 | XLT135/XLT19 5 Ø18X1 HANDLE TUBE | 1 | PZ | VI1685A0 | M6X6 STAINLESS STEEL SCREW | 4 | PZ | VI1930A0 | 5X25 ST. STEEL SCREW CHIP | 2 | PZ | VM1720A0 | XL405 DOOR WASKER | 1 | PZ | VT1086B0 | XLT195\XLT19 3 DOOR BLACK GLASS 399X661 | 1 | PZ | VT1086B0 | XLT195\XLT19 3 DOOR BLACK GLASS 399X661 | 1 | PZ |
| Code | Description | Qty | UOM | | | | | | | | | | | | | | | | | | | | | | | | | | | | | | | | | | | | | | | | | | |
| GN1320A1 | DOOR GLASS GASKET | 2 | PZ | | | | | | | | | | | | | | | | | | | | | | | | | | | | | | | | | | | | | | | | | | |
| GN1330A0 | FERRITIC PLATE GASKET XL40 | 1 | PZ | | | | | | | | | | | | | | | | | | | | | | | | | | | | | | | | | | | | | | | | | | |
| MG1015B0 | L.MISS/L.MICR O/CHEFTOP HANDLE END | 2 | PZ | | | | | | | | | | | | | | | | | | | | | | | | | | | | | | | | | | | | | | | | | | |
| TB1077A0 | XLT135/XLT19 5 Ø18X1 HANDLE TUBE | 1 | PZ | | | | | | | | | | | | | | | | | | | | | | | | | | | | | | | | | | | | | | | | | | |
| VI1685A0 | M6X6 STAINLESS STEEL SCREW | 4 | PZ | | | | | | | | | | | | | | | | | | | | | | | | | | | | | | | | | | | | | | | | | | |
| VI1930A0 | 5X25 ST. STEEL SCREW CHIP | 2 | PZ | | | | | | | | | | | | | | | | | | | | | | | | | | | | | | | | | | | | | | | | | | |
| VM1720A0 | XL405 DOOR WASKER | 1 | PZ | | | | | | | | | | | | | | | | | | | | | | | | | | | | | | | | | | | | | | | | | | |
| VT1086B0 | XLT195\XLT19 3 DOOR BLACK GLASS 399X661 | 1 | PZ | | | | | | | | | | | | | | | | | | | | | | | | | | | | | | | | | | | | | | | | | | |
| VT1086B0 | XLT195\XLT19 3 DOOR BLACK GLASS 399X661 | 1 | PZ | | | | | | | | | | | | | | | | | | | | | | | | | | | | | | | | | | | | | | | | | | |



ASM1311A/0.D01 - External cover

FRONT

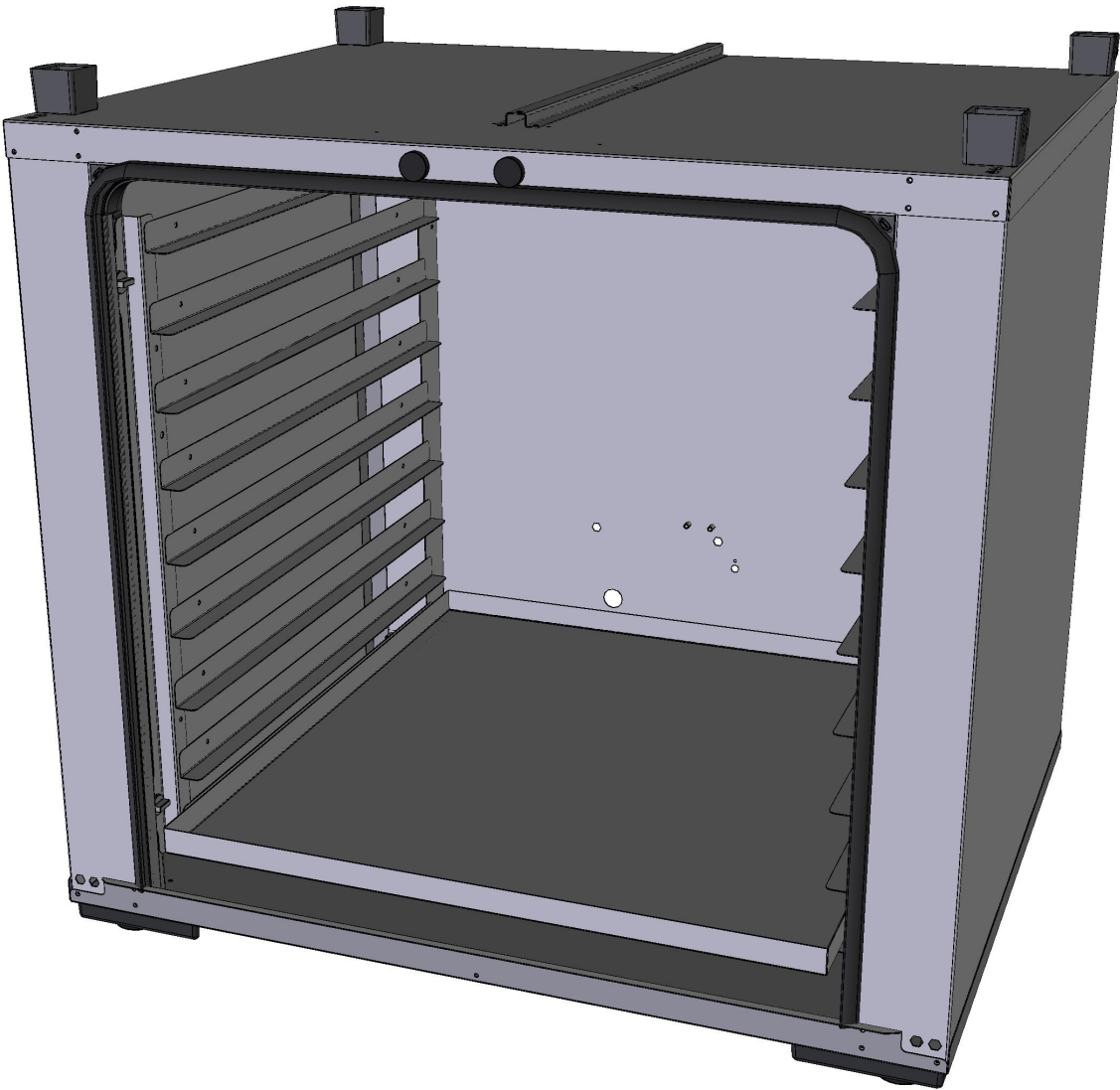



ASM1311A/0.D01 - External cover





REAR







| COMPONENT | | | SPARE PART | | | | | | | | | | | | | | |
|-----------|--|---|------------|-------------------------------|--|------|-------------|-----|-----|----------|---------------------------------|----|----|----------|--|---|----|
| Code | Description | Image | Code | Description | Components list | | | | | | | | | | | | |
| VM1750A | BRASS COMB CLAM |  | KVM1750A | COMB TERMINAL BLOCK KIT | <table border="1"> <thead> <tr> <th>Code</th> <th>Description</th> <th>Qty</th> <th>UOM</th> </tr> </thead> <tbody> <tr> <td>VM1750A0</td> <td>BRASS COMB CLAMP</td> <td>1</td> <td>PZ</td> </tr> </tbody> </table> | Code | Description | Qty | UOM | VM1750A0 | BRASS COMB CLAMP | 1 | PZ | | | | |
| Code | Description | Qty | UOM | | | | | | | | | | | | | | |
| VM1750A0 | BRASS COMB CLAMP | 1 | PZ | | | | | | | | | | | | | | |
| VM1820A | LATERAL SUPPORTS M6 FIXING BOLT |  | KVM1820A | THUMB SCREW 10PCS KIT | <table border="1"> <thead> <tr> <th>Code</th> <th>Description</th> <th>Qty</th> <th>UOM</th> </tr> </thead> <tbody> <tr> <td>VM1820A0</td> <td>LATERAL SUPPORTS M6 FIXING BOLT</td> <td>10</td> <td>PZ</td> </tr> </tbody> </table> | Code | Description | Qty | UOM | VM1820A0 | LATERAL SUPPORTS M6 FIXING BOLT | 10 | PZ | | | | |
| Code | Description | Qty | UOM | | | | | | | | | | | | | | |
| VM1820A0 | LATERAL SUPPORTS M6 FIXING BOLT | 10 | PZ | | | | | | | | | | | | | | |
| VM1281A | TRIANGULAR BRACKET FOR FOOT AND WHEEL |  | VM1281A2 | TRIANGULAR SUPPORT FOOT-WHEEL | | | | | | | | | | | | | |
| VM1645A | XL405 PROOFER CORNER GASKET |  | VM1645A1 | XL405 PROOFER CORNER GASKET | | | | | | | | | | | | | |
| VE1607A | RUBBER MAGNETIC SUCTION CUP |  | KVE1607A | MAGNETIC SUCTION CUP | <table border="1"> <thead> <tr> <th>Code</th> <th>Description</th> <th>Qty</th> <th>UOM</th> </tr> </thead> <tbody> <tr> <td>VE1607A1</td> <td>RUBBER MAGNETIC SUCTION CUP</td> <td>2</td> <td>PZ</td> </tr> <tr> <td>V11700A0</td> <td>18X6.4X1.5 STAINLESS STEEL FLAT WASHER</td> <td>2</td> <td>PZ</td> </tr> </tbody> </table> | Code | Description | Qty | UOM | VE1607A1 | RUBBER MAGNETIC SUCTION CUP | 2 | PZ | V11700A0 | 18X6.4X1.5 STAINLESS STEEL FLAT WASHER | 2 | PZ |
| Code | Description | Qty | UOM | | | | | | | | | | | | | | |
| VE1607A1 | RUBBER MAGNETIC SUCTION CUP | 2 | PZ | | | | | | | | | | | | | | |
| V11700A0 | 18X6.4X1.5 STAINLESS STEEL FLAT WASHER | 2 | PZ | | | | | | | | | | | | | | |



| COMPONENT | | | SPARE PART | | | | | | | | | | | | | | | | | | | | | | | | | | |
|-----------|---|---|------------|--|---|------|-------------|-----|-----|----------|--|----|----|----------|---------------------------|---|----|----------|------------------------------------|---|----|----------|---|-------|---|----------|--------------------------|-------|---|
| Code | Description | Image | Code | Description | Components list | | | | | | | | | | | | | | | | | | | | | | | | |
| PD1065A | ACCESSORY FOOT D45 H20 M10X40 |  | KPD1065A | H20 M10X37 D45 FEET 4PCS KIT | <table border="1"> <thead> <tr> <th>Code</th> <th>Description</th> <th>Qty</th> <th>UOM</th> </tr> </thead> <tbody> <tr> <td>PD1065A0</td> <td>ACCESSORY FOOT D45 H20 M10X40</td> <td>4</td> <td>PZ</td> </tr> </tbody> </table> | Code | Description | Qty | UOM | PD1065A0 | ACCESSORY FOOT D45 H20 M10X40 | 4 | PZ | | | | | | | | | | | | | | | | |
| Code | Description | Qty | UOM | | | | | | | | | | | | | | | | | | | | | | | | | | |
| PD1065A0 | ACCESSORY FOOT D45 H20 M10X40 | 4 | PZ | | | | | | | | | | | | | | | | | | | | | | | | | | |
| 0H1187A | XLT193 CABLES COVER |  | 0H1187A1 | XLT193 CABLES COVER | | | | | | | | | | | | | | | | | | | | | | | | | |
| 0H1181A | GASKET LATERAL PROFILE XLT135/13 |  | 0H1181A2 | GASKET LATERAL PROFILE XLT135/13 | | | | | | | | | | | | | | | | | | | | | | | | | |
| GRL1324A | LMISS 800 PROOFER LEFT LATERAL GRID |  | KGRL1324A | XLT195/193 8 TRAYS LATERAL SUPPORT KIT | <table border="1"> <thead> <tr> <th>Code</th> <th>Description</th> <th>Qty</th> <th>UOM</th> </tr> </thead> <tbody> <tr> <td>0H6832A0</td> <td>XLT195-XR190 TRAYS GUIDE PROFILE</td> <td>18</td> <td>PZ</td> </tr> <tr> <td>0H6833A0</td> <td>XLT TRAYS GUIDE PROFIL</td> <td>2</td> <td>PZ</td> </tr> <tr> <td>0H6834A0</td> <td>XLT BACK TRAYS GUIDE PROFILE</td> <td>2</td> <td>PZ</td> </tr> <tr> <td>IP1508A1</td> <td>POLYSTYREN E U SHAPED PROFILE 2000X60X60</td> <td>1.500</td> <td>M</td> </tr> <tr> <td>VM1059A1</td> <td>HEAT SHRINK FILM H800</td> <td>1.500</td> <td>M</td> </tr> </tbody> </table> | Code | Description | Qty | UOM | 0H6832A0 | XLT195-XR190 TRAYS GUIDE PROFILE | 18 | PZ | 0H6833A0 | XLT TRAYS GUIDE PROFIL | 2 | PZ | 0H6834A0 | XLT BACK TRAYS GUIDE PROFILE | 2 | PZ | IP1508A1 | POLYSTYREN E U SHAPED PROFILE 2000X60X60 | 1.500 | M | VM1059A1 | HEAT SHRINK FILM H800 | 1.500 | M |
| Code | Description | Qty | UOM | | | | | | | | | | | | | | | | | | | | | | | | | | |
| 0H6832A0 | XLT195-XR190 TRAYS GUIDE PROFILE | 18 | PZ | | | | | | | | | | | | | | | | | | | | | | | | | | |
| 0H6833A0 | XLT TRAYS GUIDE PROFIL | 2 | PZ | | | | | | | | | | | | | | | | | | | | | | | | | | |
| 0H6834A0 | XLT BACK TRAYS GUIDE PROFILE | 2 | PZ | | | | | | | | | | | | | | | | | | | | | | | | | | |
| IP1508A1 | POLYSTYREN E U SHAPED PROFILE 2000X60X60 | 1.500 | M | | | | | | | | | | | | | | | | | | | | | | | | | | |
| VM1059A1 | HEAT SHRINK FILM H800 | 1.500 | M | | | | | | | | | | | | | | | | | | | | | | | | | | |

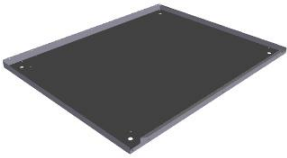
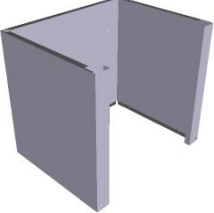

| COMPONENT | | | SPARE PART | | | | | | | | | | | | | | | | | | | | | | | | | | |
|-----------|---|---|------------|--|---|------|-------------|-----|-----|----------|--|----|----|----------|---------------------------|---|----|----------|------------------------------------|---|----|----------|---|-------|---|----------|--------------------------|-------|---|
| Code | Description | Image | Code | Description | Components list | | | | | | | | | | | | | | | | | | | | | | | | |
| GRL1325A | LMISS 800 PROOFER RIGHT LATERAL GRID |  | KGRL1324A | XLT195/193 8 TRAYS LATERAL SUPPORT KIT | <table border="1"> <thead> <tr> <th>Code</th> <th>Description</th> <th>Qty</th> <th>UOM</th> </tr> </thead> <tbody> <tr> <td>0H6832A0</td> <td>XLT195-XR190 TRAYS GUIDE PROFILE</td> <td>18</td> <td>PZ</td> </tr> <tr> <td>0H6833A0</td> <td>XLT TRAYS GUIDE PROFIL</td> <td>2</td> <td>PZ</td> </tr> <tr> <td>0H6834A0</td> <td>XLT BACK TRAYS GUIDE PROFILE</td> <td>2</td> <td>PZ</td> </tr> <tr> <td>IP1508A1</td> <td>POLYSTYREN E U SHAPED PROFILE 2000X60X60</td> <td>1.500</td> <td>M</td> </tr> <tr> <td>VM1059A1</td> <td>HEAT SHRINK FILM H800</td> <td>1.500</td> <td>M</td> </tr> </tbody> </table> | Code | Description | Qty | UOM | 0H6832A0 | XLT195-XR190 TRAYS GUIDE PROFILE | 18 | PZ | 0H6833A0 | XLT TRAYS GUIDE PROFIL | 2 | PZ | 0H6834A0 | XLT BACK TRAYS GUIDE PROFILE | 2 | PZ | IP1508A1 | POLYSTYREN E U SHAPED PROFILE 2000X60X60 | 1.500 | M | VM1059A1 | HEAT SHRINK FILM H800 | 1.500 | M |
| Code | Description | Qty | UOM | | | | | | | | | | | | | | | | | | | | | | | | | | |
| 0H6832A0 | XLT195-XR190 TRAYS GUIDE PROFILE | 18 | PZ | | | | | | | | | | | | | | | | | | | | | | | | | | |
| 0H6833A0 | XLT TRAYS GUIDE PROFIL | 2 | PZ | | | | | | | | | | | | | | | | | | | | | | | | | | |
| 0H6834A0 | XLT BACK TRAYS GUIDE PROFILE | 2 | PZ | | | | | | | | | | | | | | | | | | | | | | | | | | |
| IP1508A1 | POLYSTYREN E U SHAPED PROFILE 2000X60X60 | 1.500 | M | | | | | | | | | | | | | | | | | | | | | | | | | | |
| VM1059A1 | HEAT SHRINK FILM H800 | 1.500 | M | | | | | | | | | | | | | | | | | | | | | | | | | | |
| 0E1004B | XLT195XLT193 EXTERNAL BOTTOM PANEL |  | 0E1004B0 | XLT195XLT193 EXTERNAL BOTTOM PANEL | | | | | | | | | | | | | | | | | | | | | | | | | |
| 0D1034B | XLT195XLT193 EXTERNAL CASING |  | 0D1034B0 | XLT195XLT193 EXTERNAL CASING | | | | | | | | | | | | | | | | | | | | | | | | | |
| VM1029A | L.MISS STACKING FOOT RISE |  | KVM1029A | L.MISS STACKING FOOT RISE 50 PCS KIT | <table border="1"> <thead> <tr> <th>Code</th> <th>Description</th> <th>Qty</th> <th>UOM</th> </tr> </thead> <tbody> <tr> <td>VM1029A0</td> <td>L.MISS STACKING FOOT RISE</td> <td>50</td> <td>PZ</td> </tr> </tbody> </table> | Code | Description | Qty | UOM | VM1029A0 | L.MISS STACKING FOOT RISE | 50 | PZ | | | | | | | | | | | | | | | | |
| Code | Description | Qty | UOM | | | | | | | | | | | | | | | | | | | | | | | | | | |
| VM1029A0 | L.MISS STACKING FOOT RISE | 50 | PZ | | | | | | | | | | | | | | | | | | | | | | | | | | |

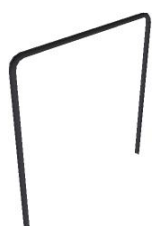
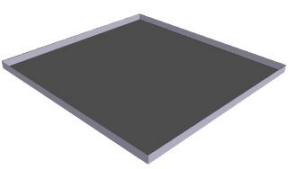
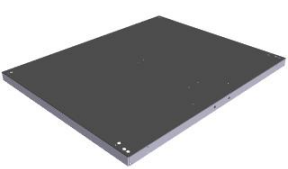

| COMPONENT | | | SPARE PART | | | | | | | | | | | | | | | | | | |
|-----------|--|---|------------|--|---|------|-------------|-----|-----|----------|------|-------|---|--|-----------------------|--|--|--|------------|--|--|
| Code | Description | Image | Code | Description | Components list | | | | | | | | | | | | | | | | |
| 0H1188A | GASKET UPPER PROFILE XLT195 XLT193 |  | 0H1188A2 | GASKET UPPER PROFILE XLT195 XLT193 | | | | | | | | | | | | | | | | | |
| GN1521A | XFT ROSSELLA OVEN DOOR GASKE |  | KGN1521A | XLT193/XLT195 DOOR GASKET KIT | <table border="1"> <thead> <tr> <th>Code</th> <th>Description</th> <th>Qty</th> <th>UOM</th> </tr> </thead> <tbody> <tr> <td>GN1110A2</td> <td>LINE</td> <td>1.830</td> <td>M</td> </tr> <tr> <td></td> <td>MISS/XVC105-055/XK/XL</td> <td></td> <td></td> </tr> <tr> <td></td> <td>DOOR GASKE</td> <td></td> <td></td> </tr> </tbody> </table> | Code | Description | Qty | UOM | GN1110A2 | LINE | 1.830 | M | | MISS/XVC105-055/XK/XL | | | | DOOR GASKE | | |
| Code | Description | Qty | UOM | | | | | | | | | | | | | | | | | | |
| GN1110A2 | LINE | 1.830 | M | | | | | | | | | | | | | | | | | | |
| | MISS/XVC105-055/XK/XL | | | | | | | | | | | | | | | | | | | | |
| | DOOR GASKE | | | | | | | | | | | | | | | | | | | | |
| 0H1192A | XLT195 WATER TRA |  | 0H1192A0 | XLT195 WATER TRA | | | | | | | | | | | | | | | | | |
| 0D1038A | XLT193 COVER |  | 0D1038A1 | XLT193 COVER | | | | | | | | | | | | | | | | | |