

Bedienblende Control panel	Spannung Voltage	Baugruppe Group	Ausgabe Edition	gültig ab Seriennummer Applicable from Serial.No.
	3 N AC 400V 50Hz	1	1.1.2	C61C95057001

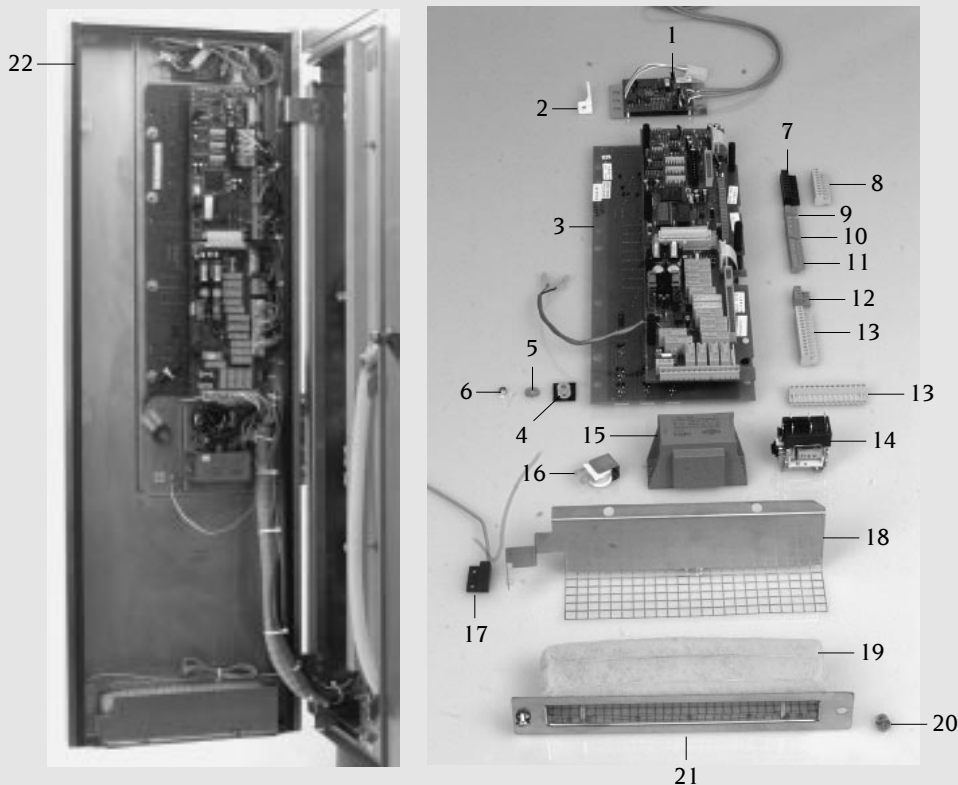

Pos.	St.	Ersatz.Nr.	Bezeichnung	Description
Pos.	Pcs.	Sp. Part No.		
-	1	8461.1203	Bedienblende kpl.	Control panel cpl.
-	1	8720.1207	Bedienblende mit Folie	Control panel with overlay
-	1	8464.1200	Filterträger kpl.	Air inlet filter cpl.
1	1	3040.2602	Platine kpl. f. Feuchtmotor	PCB complete for sensor motor
2	1	2020.0400	Befestigungselement kurz	Cabel holder short
3	1	3040.2040	Regel- und Steuerelektronik	PCB complete
4	9	2039.0326	Silikonfeder	Silicone spacer
5	9	1305.0160	Unterlegscheibe A5,3	Washer A5,3
6	9	1105.0124	Sechskantmutter selbstsichernd M5	Hexagonal nut self-locking M5
7	1	3040.0231	Steckerleiste schwarz BL 10	Multipoint connector black BL 10
8	1	3040.0232	Steckerleiste grau BL 10	Multipoint connector grey BL 10
9	1	3040.0229	Steckerleiste BL 3	Multipoint connector BL 3
10	1	3040.0228	Steckerleiste BL 9	Multipoint connector BL 9
11	1	3040.0227	Steckerleiste BL 12	Multipoint connector BL 12
12	1	3040.0194	Steckerleiste BL 4	Multipoint connector BL 4
13	2	3040.0230	Steckerleiste BL 15	Multipoint connector BL 15
14	1	3028.0601	Kleinschütz E 3250, 24V	Mini contactor E 3250, 24V
15	1	3037.0203	Steuertrafo 35VA	Transformer 35VA
16	1	3006.0103	Alarmsummer	Alarm buzzer
17	1	3016.1408	Türkontaktschalter	Door contact switch
-	1	3016.1409	Magnet rund Tischgeräte	Magnet round table models
18	1	2712.1200	Türkontaktträger	Door contact mounting bracket
-	2	1103.0600	Spreizmutter 2mm	Expansion nut 2mm for self-tapping screw
-	2	1304.0150	Unterlegscheibe A3,2	Washer A3,2
-	2	1003.2160	Sechskant Blechschraube A2,9x9,5	Hex self-tapping screw A2,9x9x5
19	1	5214.1208	Filtermatte	Filter gaze
20	2	2043.0205	Verschlußbolzen	Locking pin
21	1	8464.1201	Filterträger	Air inlet filter
22	1	5105.1011	Dichtungsrahmen f. Bedienblende	Gasket frame for panel

Elektromontageplatte Electrical installation	Spannung Voltage	Baugruppe Group	Ausgabe Edition	gültig ab Seriennummer Applicable from Serial.No.
	3 N AC 400V 50Hz	2	2.1.2	C61C95057001

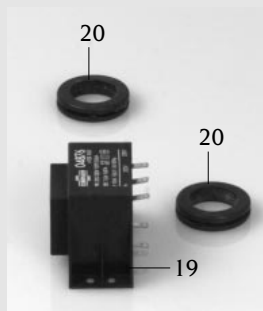
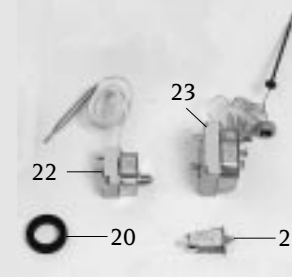
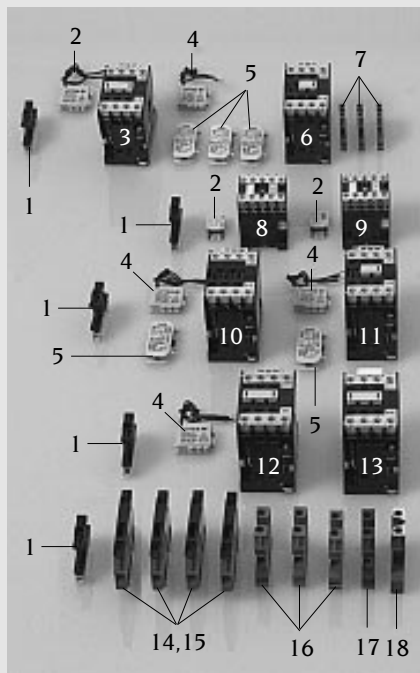

Pos.	St.	Ersatz.Nr.	Bezeichnung	Description
Pos.	Pcs.	Sp. Part No.		
-	1	8950.1202	Montageplatte 3 N AC 400V 50Hz	Mounting plate 3 N AC 400V 50Hz
1	5	4001.1203	Endklammer für Tragschiene	End plate for supporting rail
2	3	3035.0517	RC-Glied	RC-Link
3	1	3028.0507	Schütz LS 04.01 200-240V 50/60Hz	Contacteur LS 04.01 200-240V 50/60Hz
4	4	3035.0521	RC-Glied	RC-Link
5	5	3028.0153	Hilfskontaktschalter HS 17.10	Auxiliary contact switch HS 17.10
6	1	3028.0507	Schütz LS 04.01 200-240V 50/60Hz	Contacteur LS 04.01 200-240V 50/60Hz
7	3	4001.1216	Reihenklemme 4mm ² grau	Terminal 4mm ² grey
8	1	3028.0504	Schütz LS 05.01 230V 50/60Hz	Contacteur LS 05.01 230V 50/60Hz
9	1	3028.0504	Schütz LS 05.01 230V 50/60Hz	Contacteur LS 05.01 230V 50/60Hz
10	1	3028.0507	Schütz LS 04.01 200-240V 50/60Hz	Contacteur LS 04.01 200-240V 50/60Hz
11	1	3028.0507	Schütz LS 04.01 200-240V 50/60Hz	Contacteur LS 04.01 200-240V 50/60Hz
12	1	3028.0517	Schütz LS 17.4 200-240V 50/60Hz	Contacteur LS 17.4 200-240V 50/60Hz
13	1	3028.0506	Schütz LS 04.10 200-240V 50/60Hz	Contacteur LS 04.10 200-240V 50/60Hz
14	4	4001.1247	Sicherungsklemme	Safety terminal
15	4	4001.0218	Feinsicherung 6,3A	Fuse 6,3A
16	3	4001.1202	Reihenklemme 16mm ² grau	Terminal 16mm ² grey
17	1	4001.1250	Reihenklemme 16mm ² blau	Terminal 16mm ² blue
18	1	4001.1210	Erdungsreihenklemme 16mm ² gelb/grün	Earth terminal 16mm ² yellow/green
19	1	3037.0205	Halogentrafo 10VA	Halogen transformer 10VA
20	2	2022.0105	Durchführungsstülpe d 26mm	Lead-in grommet d 26 mm
-	1	3102.1000	Wechselspannungskondensator 1,5µF,250V	Capacitor 1,5µF,250V AC
21	1	3014.0400	Überstromauslöser einpolig f. Motorschutz	Current limiter for motor protection
22	1	3014.0300	Trockengehschutz 125°C	Dry up protector 125°C
-	1	3014.0302	Sechskantmutter M 10x1,5mm	Hexagonal nut M 10x1,5mm
23	1	3014.0322	Sicherheitstemperaturbegrenzer 360°C	Safety temperature limiter 360°C

ClimaPlus	Spannung	Baugruppe	Ausgabe	gültig ab Seriennummer
ClimaPlus	Voltage	Group	Edition	Applicable from Serial.No.
	3 N AC 400V 50Hz	3	3.1.2	C61C95057001

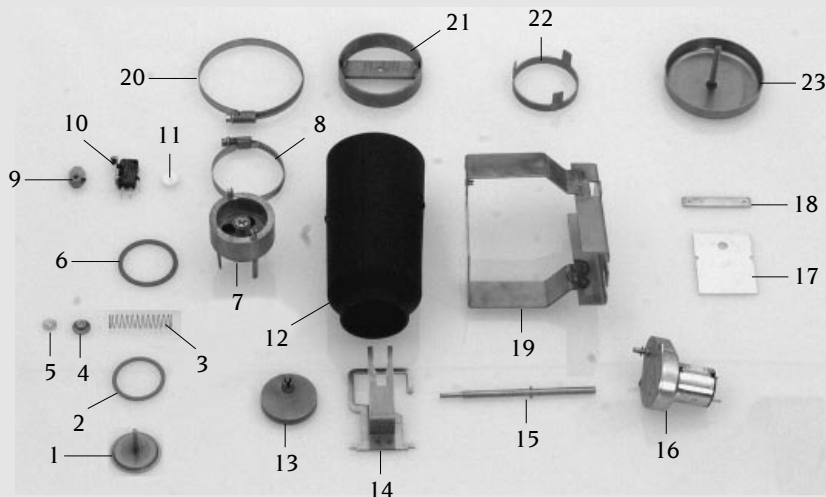
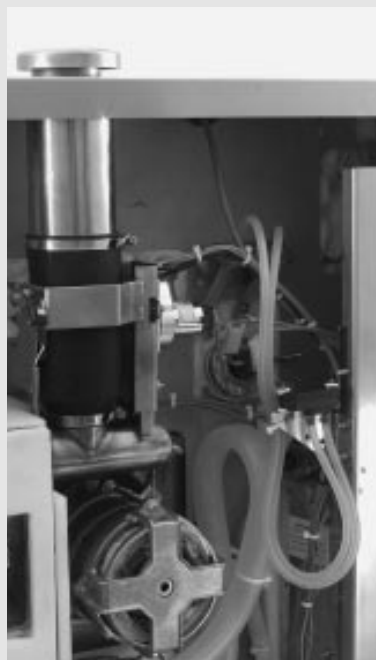

Pos.	St.	Ersatz.Nr.	Bezeichnung	Description
Pos.	Pcs.	Sp. Part No.		
-	1	3040.2602	Platine kpl. f. Feuchtmotor	PCB complete for sensor motor
-	1	8450.1003	Be- und Entlüftung kpl.	Humidity control cpl.
-	1	8450.1200	Sicherheitsventil kpl.	Safety valve unit
1	1	2064.1200	Unterdruckstempel	Vacuum/depression ram
2	1	2064.1003	Unterdruckdichtung	Vacuum/depression gasket
3	1	2064.1002	Unterdruckfeder	Vacuum/depression spring f
4	1	1105.0122	Sechskant-Combi-Mutter M 5	Hexagonal combination nut M5
5	1	1107.0100	Schnellbefestiger 4,0 mm	Quick fastener 4.0 mm
6	1	2064.1004	Überdruckgewichtdichtung	Overpressure weight gasket
7	1	2940.1200	Überdruckgewicht	Overpressure weight
8	1	2066.0504	Schlauchschelle 40-60mm	Hose clamp 40-60mm
9	1	2940.1201	Nocke	Cam
-	1	1004.0900	Gewindestift M3x8	Allen set screw M3x8
10	1	3016.0101	Mikroschalter	Micro switch humidity control
-	2	1003.0033	Zylinderschraube M3x16	Slotted head screw M3x16
-	2	1304.0150	Unterlegscheibe A3,2	Washer A3,2
11	1	2016.1002	Teflonbuchse	Teflon bearing
12	1	2118.1200	Manschette Be- und Entlüftung	Form rubber humidity control
13	1	2940.1202	Exzenter	Excenter humidity control
-	1	1251.1000	Sicherungsring 5mm	Guard ring 5mm
14	1	8680.1201	Bügel für Überdruckgewicht	Holding bracket safety valve
-	2	1107.0101	Schnellbefestiger d5,0mm	Quick fastener d5,0mm
15	1	2120.1200	Antriebswelle	Drive shaft humidity control
16	1	3101.1007	Belüftungsstellmotor 24V	Humidity control motor 24V
-	2	1003.0020	Flachkopfschraube M3x10	Pan head screw M3x10
-	2	1304.0150	Unterlegscheibe A3,2	Washer A3,2
17	1	5010.1200	Dämmplatte A2x50x65	Insulating slab A2x50x65
18	1	2930.1200	Gewindeplatte	Mounting bracket humidity control motor
19	1	8680.1200	Halter für Belüftungsstellmotor	Bracket for humididy control motor
20	1	2066.0505	Schlauchschelle 70-90mm	Hose clamp 70-90mm
21	1	8455.1207	Glockenhalter	Vent cover bracket
22	1	2910.1206	Abstandshalter für Glocke	Distance holder for vent cover
23	1	8455.1209	Glocke	Vent cover

ClimaPlus	Spannung	Baugruppe	Ausgabe	gültig ab Seriennummer
ClimaPlus	Voltage	Group	Edition	Applicable from Serial.No.
	3 N AC 400V 50Hz	3	3.2.1	C61C95057001

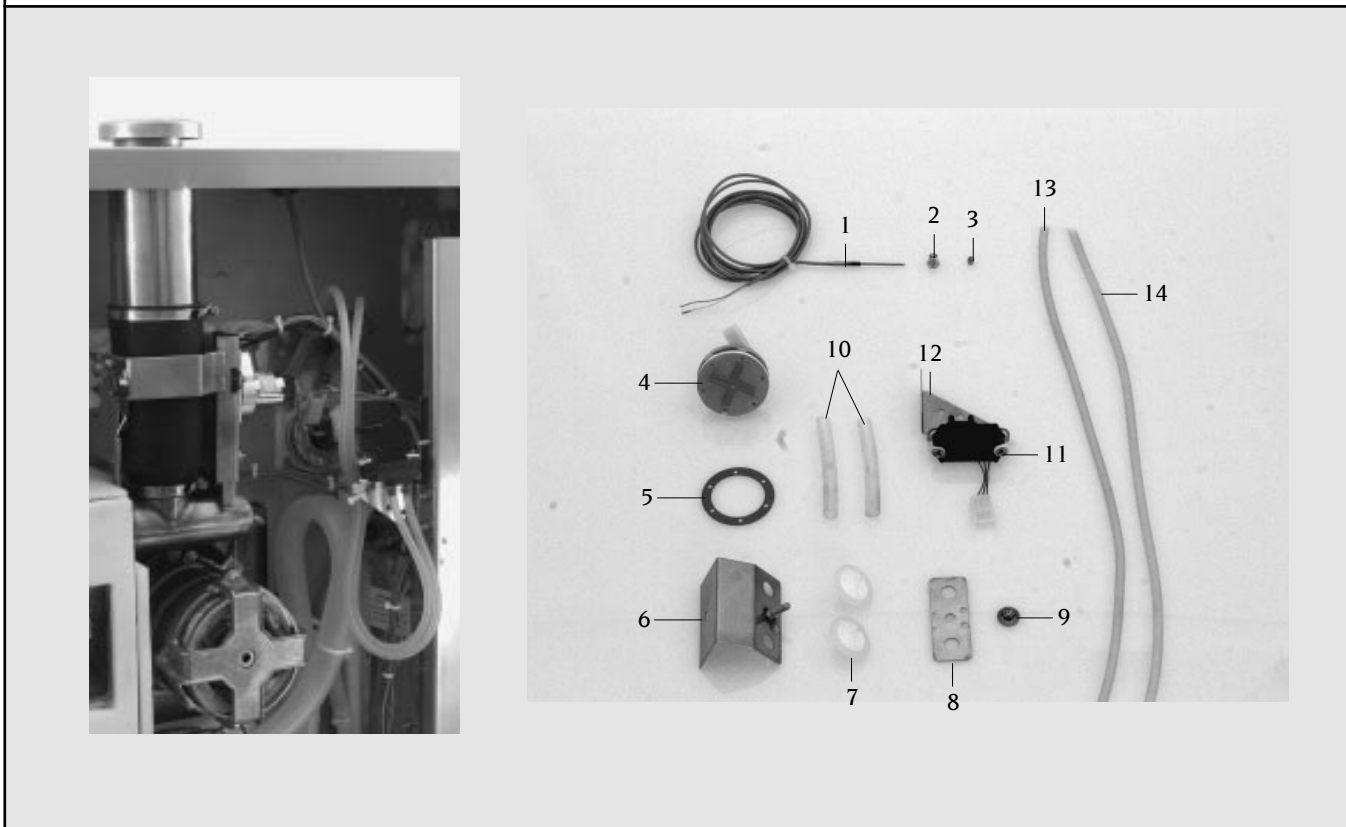

Pos. Pos.	St. Pcs.	Ersatz-Nr. Sp. Part No.	Bezeichnung	Description
-	1	8720.1002	Mantelthermoelement kpl. kurz (Pos. 1,2,3)	Sheath thermo element cpl. short (pos. 1,2,3)
1	1	3014.0161	Mantelthermoelement kurz	Sheath thermo element short
2	1	3014.0163	Stopfbuchsnippel für Thermoelement	Gasket sleeve with nipple
3	1	3014.0162	Dichtkegel für Thermoelement	Sealing cone for thermo element
4	1	8680.1006	Motor f. Feuchtmessung kpl.	Sensor motor cpl.
5	1	5110.1008	Dichtring f. Feuchtmotor	Seal ring for sensor motor
-	6	1304.0150	Unterlegscheibe A3,2	Washer A3,2
-	6	1103.0122	Sechskantmutter selbstsichernd M3	Hexagonal nut self-locking M3
6	1	8680.1016	Haltewinkel für Kondensatfilter unten	Holder below for condensation filter
7	2	1900.0201	Kondensatfilter	Condensation filter
8	1	2760.1067	Halteplatte für Kondensatfilter oben	Holder top for condensation filter
9	1	1105.0122	Sechskant-Combi-Mutter M 5	Hexagonal combination nut M5
10	2	2112.1014	Druckschlauch d 8x2x80mm	Pressure hose d 8x2x80 mm
-	2	2112.1015	Druckschlauch d 5x1,5x10mm	Pressure hose d 5x1,5x10mm
11	1	3017.1001	Drucksensor	Pressure sensor
12	1	8680.1019	Haltewinkel für Drucksensor	Holder below for pressure sensor
-	4	2039.0325	Siliconpuffer Id3/Ad12	Silicone buffer Id3/Ad12
13	1	2112.1013	Druckschlauch rot d 3x2,5x500mm	Pressure hose red d 3x2,5x500mm
14	1	2112.1012	Druckschlauch blau d3x2,5x500mm	Pressure hose blue d 3x2,5x500mm

3

Dampfgenerator Steam generator	Spannung Voltage	Baugruppe Group	Ausgabe Edition	gültig ab Seriennummer Applicable from Serial.No.
	3 N AC 400V 50Hz	4	4.1.2	C61C95057001

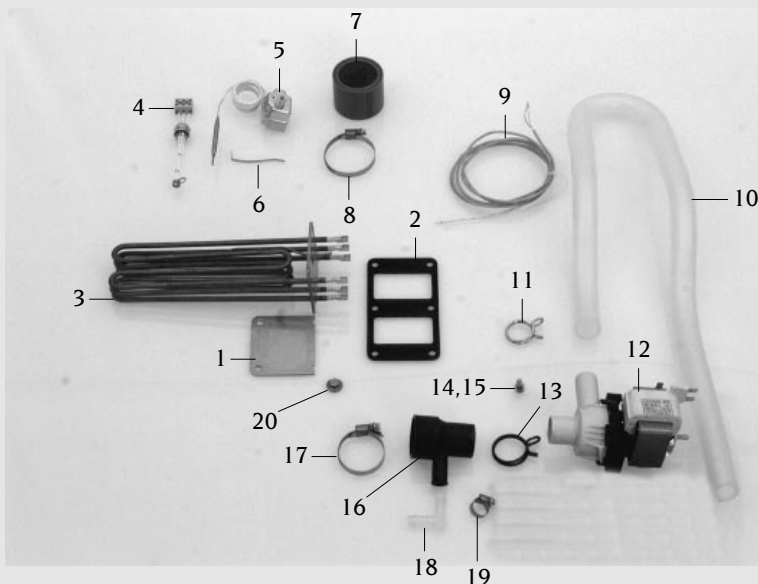

Pos. Pos.	St. Pcs.	Ersatz.Nr. Sp. Part No.	Bezeichnung	Description
-	1	8720.1203	Dampfgenerator kpl. 230V/50Hz	Steam generator cpl. 230V/50Hz
-	1	8720.1200	Dampfgenerator isoliert	Steam generator insulated
-	1	5212.1200	Isolierung für Dampfgenerator	Insulation for steam generator
1	1	2150.1203	Flansch für Dampfgenerator	Blanking plate
2	1	5110.1200	Dichtung f. Tauchheizkörper	Gasket for heating element
3	1	3201.1200	Tauchheizkörper 3x3 kw 230V	Heating element 3x3 kw 230V
4	1	3002.0402	Füllstandselektrode 90mm	Filling level electrode 90mm
5	1	3014.0300	Trockengehschutz 125 °C	Dry up protector 125 °C
6	1	2740.1040	Klemmblech Dampfgenerator	Clamping plate for steam generator
7	1	2112.1006	Dampfschlauch 50x7mm	Steam hose 50x7mm
8	1	2066.0300	Schlauchselle 50-70mm	Hose clamp 50-70mm
9	2	3014.0165	Thermoelement Dampfgenerator	Thermo element steam generator
10	1	2112.1201	Entleerschlauch	Emptying hose
11	1	2066.0522	Schlauchklemme 31,3mm	Hose clamp 31,3mm
12	1	3002.1000	Entleerpumpe 200-240V 50/60Hz	Emptying pump 200-240V 50/60Hz
13	2	2066.0519	Schlauchklemme 35,6mm	Hose clamp 35,6mm
14	2	1006.0621	Innensechskantschraube M 6x12	Allen screw M6x12
15	2	1306.0120	Unterlegscheibe A6,4	Washer A6.4
16	1	2118.1000	Pumpenanschlußstutzen	Pump connection spout
17	1	2066.0507	Schlauchselle 32-50mm	Hose clamp 32-50mm
18	1	2062.0301	Winkelstück Kunststoff WS 10	Angle piece plastic WS 10
19	2	2066.0205	Schlauchselle 12-18mm	Hose clamp 12-18mm
20	6	1106.0801	Sechskant-Combi-Mutter M 6	Hexagonal combination nut M6

Heißluftheizung
Hot Air Heating

Spannung

Baugruppe

Ausgabe

gültig ab Seriennummer

Voltage

Group

Edition

Application from Serial.No.

3 N AC 400V 50Hz

5

5.1.1

C61C93065001

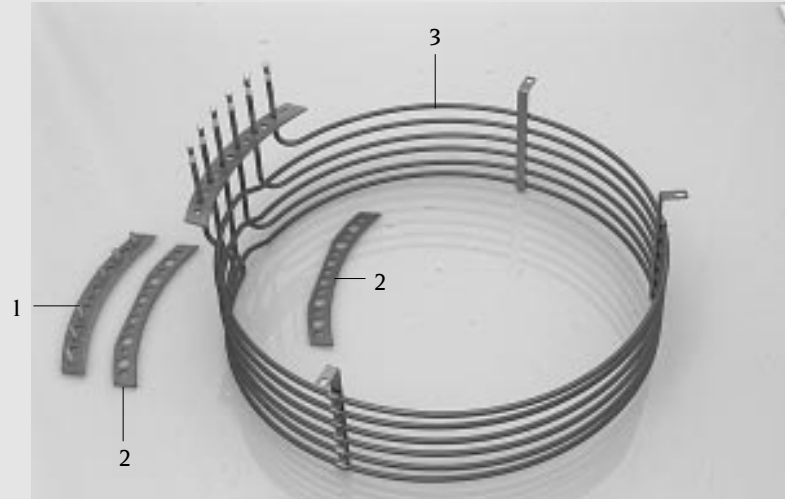

Pos.	St.	Ersatz.Nr.	Bezeichnung	Description
Pos.	Pcs.	Sp. Part No.		
1	1	2150.1005	Flansch Außenseite f. Heizregister	External flange for heating element
2	2	5110.1009	Dichtring f. Heizregister	Seal ring for heating assembly
-	9	1106.0360	Hutmutter M6	Cap nut M6
-	9	1206.0261	Federring B6	Spring washer B6
3	1	3200.1000	Heizregister 230V	Heating assembly 230V

Garraum	Spannung	Baugruppe	Ausgabe	gültig ab Seriennummer
Interior cabinet	Voltage	Group	Edition	Applicable from Serial.No.
	3 N AC 400V 50Hz	7	7.1.2	C61C95057001

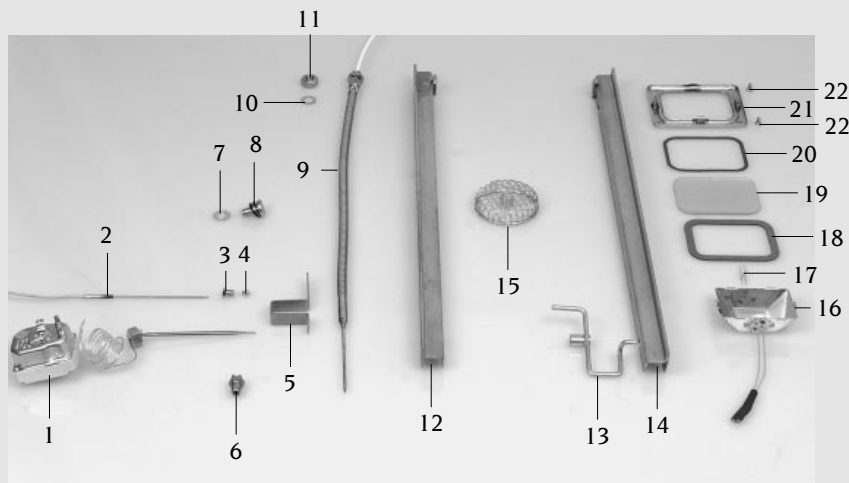

Pos.	St.	Ersatz.Nr.	Bezeichnung	Description
Pos.	Pcs.	Sp. Part No.		
-	-	8516.1025	Luftleitblech	Air baffle
-	-	8720.1003	Mantelthermoelement kpl. lang (Pos.2,3,4)	Sheath thermo element cpl. long
1	1	3014.0322	Sicherheitstemperaturbegrenzer 360°C	Safety temperature limiter 360°C
2	1	3014.0160	Mantelthermoelement lang	Sheath thermo element long
3	1	3014.0163	Stopfbuchsnippel für Thermoelement	Gasket sleeve with nipple
4	1	3014.0162	Dichtkegel für Thermoelement	Sealing cone for thermo element
5	1	2720.1073	Thermostathaltewinkel	Holding angle for thermostat
6	1	2035.0110	Zungendüse für Beschwadung	Moistening nozzle
7	2	2043.0203	Haltescheibe für Verschlußbolzen	Holder plate for locking pin
8	2	2043.0201	Verschlußbolzen für Luftleitblech	Locking pin for air baffle
9	1	3035.0700	Einstechfühler	Meat probe sensor
10	1	1315.0105	Kupferdichtring für Einstechfühler	Copper washer for meat probe sensor
11	1	1112.0110	Sechskantmutter M 10	Hexagonal nut M10
12	1	8514.1023	Einfahrschiene links	Rail left
13	1	8514.1025	Sperrklinke f. Einfahrschiene rechts	Bolt for oven rack rail right
14	1	8514.1024	Einfahrschiene rechts	Rail right
15	1	2005.0302	Ablaufsieb	Outlet sieve
16	1	8514.1018	Reflektor kpl. f. Garraumbeleuchtung	Reflector unit for interior lighting
17	1	3024.0201	Halogengarraumlampe 10 W/12V/300°	Halogen bulb 10 W/12V/300°
18	1	5110.1023	Dichtungsrahmen innen	Internal gasket frame
19	1	5201.1000	Glas f. Garraumbeleuchtung	Glass for interior lamp
20	1	5110.1022	Dichtungsrahmen außen	External gasket frame
21	1	8514.1017	Andrückrahmen f. Garraumbeleuchtung	Press down frame for interior lighting
22	4	1008.0753	Sechskantschraube M 5x8	Hexagonal screw M5x8
23	2	8514.1064	Anschlagwinkel für Trichterblech kpl.	Holding bracket air baffle
-	4	1106.0360	Hutmutter M6 hohe Form	Cap nut M6, high shape
-	4	1206.0261	Federring B6	Spring washer B6
-	4	1306.0120	Unterlegscheibe A6,4	Washer A6.4
-	1	8817.1201	Kabel für Innenbeleuchtung	Cable for interior light
-	1	4001.1248	Porzellanklemme 2 polig	Porcelain connector 2 pin interior light

Gerätetür	Spannung	Baugruppe	Ausgabe	gültig ab Seriennummer
Door	Voltage	Group	Edition	Application from Serial.No.
	3 N AC 400V 50Hz	8	8.1.1	C61C93065001

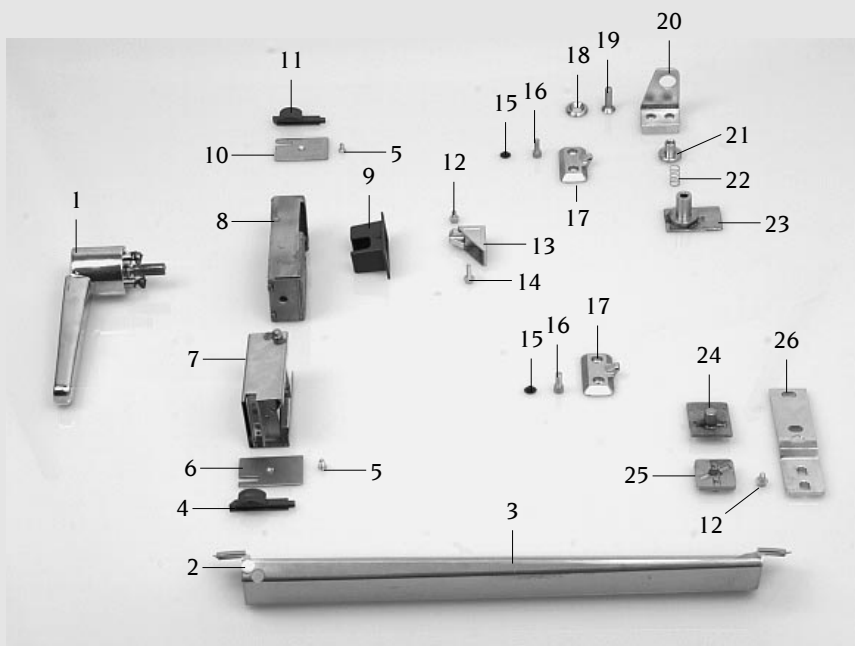

Pos.	St.	Ersatz.Nr.	Bezeichnung	Description
Pos.	Pcs.	Sp. Part No.		
-	1	8470.1002	Türe kpl.	Door unit
-	1	5105.1001	Dichtungsrahmen f. Türe/Garraum	Gasket frame for door/interior cabinet
1	1	2016.1500	Türgriff kpl.	Door-handle unit
2	1	2039.0321	Gleitkuppe f. Tropfwanne	Plastic knob for door drip collector
3	1	8474.1014	Türtropfwanne kpl.	Door drip collector
4	1	2043.0102	Riegel unten f. Außentüre	Lower bolt for external door
-	2	2001.0112	Druckfeder d 0,5x23 mm	Compression spring d 0.5x23 mm
5	4	1004.0430	Senkschraube m. Schlitz M4x16	Slotted countersunk-head screw M4x16
6	1	2760.1050	Deckel unten Verschußseitig	Lower lid on the side of the seal
7	1	8474.1008	Einschub kpl. f. Türe unten	Plug-in unit for bottom door
8	1	8474.1001	Verschuß kpl. f. Türgriff	Lock for door-handle
9	1	2039.0319	Abdeckung f. Schloß Innenseite	Internal lock cover
10	1	2760.1049	Deckel oben Verschußseitig	Upper lid on the side of the seal
11	1	2043.0101	Riegel oben f. Außentüre	Upper bolt for external door
12	3	1005.2000	Sperrzahnschraube M 5x8	Interlocking tooth screw M 5x8
13	1	2016.0610	Fangkloben kpl. Tischgeräte	Door catch unit
14	2	1005.2100	Sperrzahnschraube M 5x16	Interlocking tooth screw M5x16
15	5	2039.0309	Abdeckkappe f. Türe	Cap for door
16	4	1006.7601	Innensechskantschraube M 6x16	Allen screw M6x16
17	2	2060.1600	Lagerbock f. Außenscheibe	Bearing pedestal for external window
18	1	2120.1010	Unterlegscheibe 25x4mm	Washer 25x4mm
19	1	1008.1960	Senkschraube m. Innensechskant M 8x30	Countersunk-head screw M8x30
20	1	2930.1002	Türhaltewinkel oben	Door holding angle top
21	1	2120.1009	Türhaltebolzen oben	Door holding bolt top
22	1	2001.0111	Druckfeder f. Türhaltebolzen	Compression spring for door holding pin
23	1	8474.1009	Deckel oben kpl. drehpunktseitig	Upper lid unit at side of the pivot
24	1	8474.1010	Deckel unten kpl. drehpunktseitig	Lower lid unit at side of the pivot
25	1	2930.1001	Rastteller	Locking plate bottom
26	1	2930.1000	Türkonsole unten	Lower door console
27	1	8455.1007	Gerätetropfwanne	Drip collector
28	1	8474.1005	Glasscheibe außen kpl.	External glass pane unit

Wasseranschluß Water supply	Spannung Voltage	Baugruppe Group	Ausgabe Edition	gültig ab Seriennummer Applicable from Serial.No.
	3 N AC 400V 50Hz	9	9.1.2	C61C95057001

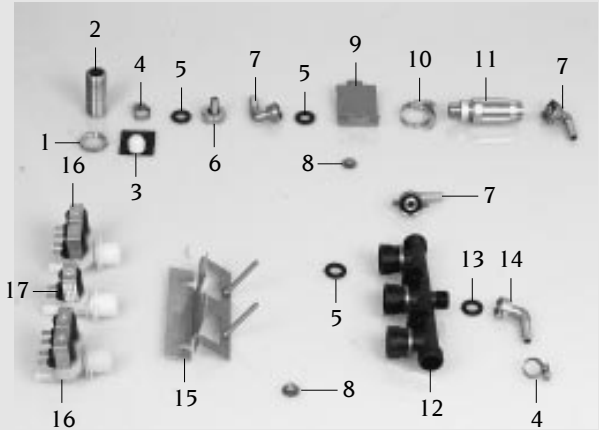
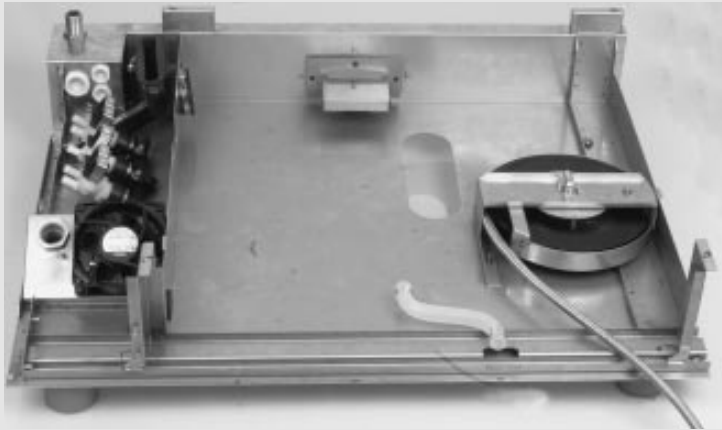

Pos.	St.	Ersatz.Nr.	Bezeichnung	Description
Pos.	Pcs.	Sp. Part No.		
-	-	2067.0050	Silikonschlauch 1m	Silicone hose 1m
1	2	2062.0313	Kontermutter G 3/4	Lock-nut G 3/4
2	1	1500.1582	Gewindenippel G3/4"	Thread nipple G3/4"
3	1	1900.0202	Wasserfilter grob	Water filter coarse
4	9	2066.0205	Schlauchschelle 12-18mm	Hose clamp 12-18mm
5	7	5110.1024	Dichtung für Verschraubung G 3/4"	Gasket for G3/4" threaded joint
6	1	2062.0314	Geradeverschraubung G 3/4	Straight threaded joint G 3/4
7	3	2062.0203	Winkelverschraubung G 3/4x10	Elbow screw point G 3/4x10
8	4	1106.0801	Sechskant-Combi-Mutter M 6	Hexagonal combination nut M6
9	1	2717.1200	Haltewinkel für Armaturenkombination	Mounting bracket for double check valve
10	1	2066.0503	Schlauchschelle 25-40mm	Hose clamp 25-40mm
11	1	2069.0103	Armaturenkombination	Valve unit with non-return valve
12	1	8664.1007	Wasserverteiler	Water distribution unit
13	1	5012.0539	Dichtung für Verschraubung G 1/2"	Gasket for G1/2" threaded joint
14	1	2062.0208	Winkelverschraubung G1/2"x10	Elbow screw point G1/2"x10
15	1	8664.1211	Halte für Wasserverteiler	Holding bracket for water manifold
16	2	3002.0330	Doppelmagnetventil kpl. 220-240V 50Hz	Double solenoid valve unit 220-240V 50Hz
17	1	3002.0331	Einfachmagnetventil kpl. 220-240V 50Hz	Single solenoid valve unit 220-240V 50Hz

Ablöschkasten	Spannung	Baugruppe	Ausgabe	gültig ab Seriennummer
Quenching box	Voltage	Group	Edition	Applicable from Serial.No.
	3 N AC 400V 50Hz	10	10.1.2	C61C95057001

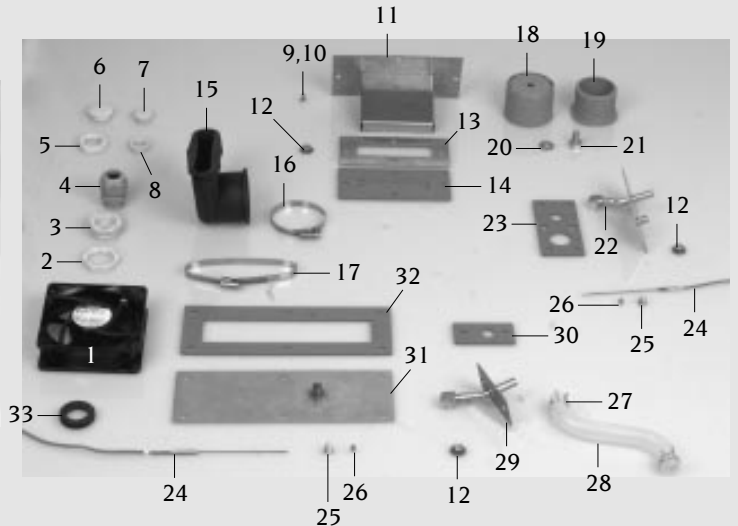
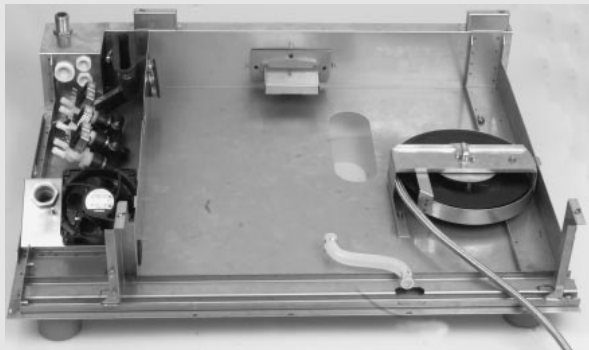

Pos.	St.	Ersatz.Nr.	Bezeichnung	Description
Pos.	Pcs.	Sp. Part No.		
-	-	2067.0050	Silikon Schlauch 1m	Silicone hose 1m
-	-	8720.1003	Mantelthermoelement kpl. lang (Pos. 24-26)	Sheath thermo element cpl. long (pos. 24-26)
1	1	3101.1008	Kühllüfter	Cooling motor
2	1	4007.0206	Sechskantmutter für PG 29	Hex screw for PG 29
3	1	4007.0406	Reduzierstück PG 29/16	Reducing socket PG 29/16
4	1	4007.0405	Kabelverschraubung PG 16	Screw-type conduit fitting PG 16
5	1	4007.0526	Sechskantmutter für PG 21	Hex screw for PG 21
6	1	4007.0615	Stopfen PG 21	Plug PG 21
7	2	4007.0614	Stopfen PG 13,5	Plug PG 13,5
8	2	4007.0521	Sechskantmutter für PG 13,5	Hex screw for PG 13,5
9	3	1004.2164	Sechskant Blechschaube A4,2x16	Hex self-tapping screw A4,2x16
10	3	1304.0160	Unterlegscheibe A4,3	Washer A4,3
11	1	8666.1200	Überlaufkanal geschweißt	Overflow box
12	18	1106.0801	Sechskant-Combi-Mutter M 6	Hexagonal combination nut M6
13	1	2715.1203	Flansch hinten	Flange for overflow box
14	1	5110.1204	Dichtung Überlaufkanal	Gasket for flange overflow box
15	1	2118.1202	Manschette Entlüftungsrohr unten	Rubber form piece venting pipe up
16	1	2066.0505	Schlauchschnelle 70-90mm	Hose clamp 70-90mm
17	1	2066.0524	Schlauchschnelle 90-110	Hose clamp 90-110
18	4	2039.0112	Fußoberteil	Upper part of pedestal
19	4	2039.0113	Fußunterteil	Lower part of pedestal
20	4	2750.1020	Unterlegscheibe A10,5	Washer A10,5
21	4	1010.0760	Sechskantschraube M 10x16	Hexagonal screw M10x16
22	1	8666.1206	Ablöschdüse D1 kpl.	Quenching nozzle D1 cpl.
23	1	5110.1201	Dichtung Ablöschdüse D1	Gasket for quenching nozzle D1
24	2	3014.0160	Mantelthermoelement lang	Sheath thermo element long
25	2	3014.0163	Stopfbuchsnippel für Thermoelement	Gasket sleeve with nipple
26	2	3014.0162	Dichtkegel für Thermoelement	Sealing cone for thermo element
27	2	2066.0525	Schlauchklemme 22,1mm	Hose clamp 22,1mm
28	1	2112.1025	Form-Entleerschlauch für Tropfwanne	Emptying hose for drip pan
29	1	8666.1204	Ablöschdüse D2 kpl.	Quenching nozzle D2 cpl.
30	1	5110.1202	Dichtung Ablöschdüse D2	Gasket for quenching nozzle D2
31	1	8666.1205	Flansch vorne	Flange quenching D2
32	1	5110.1203	Dichtung für Revisionsflansch	Gasket revision flange
33	1	2022.0105	Durchführungsstülpe d 26mm	Lead-in grommet d 26 mm

Ablöschkasten	Spannung	Baugruppe	Ausgabe	gültig ab Seriennummer
Quenching box	Voltage	Group	Edition	Applicable from Serial.No.
	3 N AC 400V 50Hz	10	10.2.1	C61C95057001

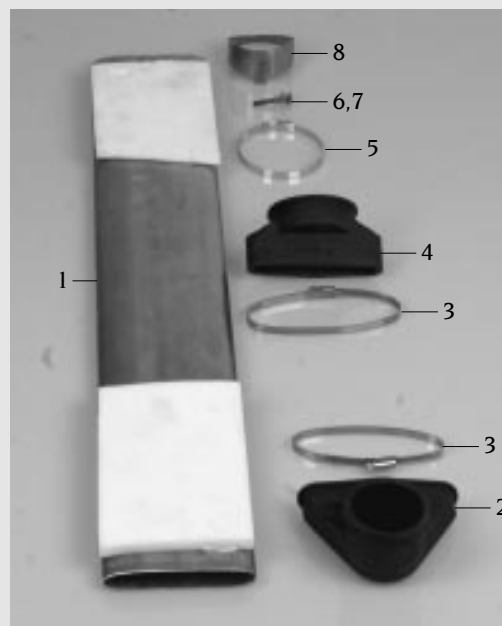
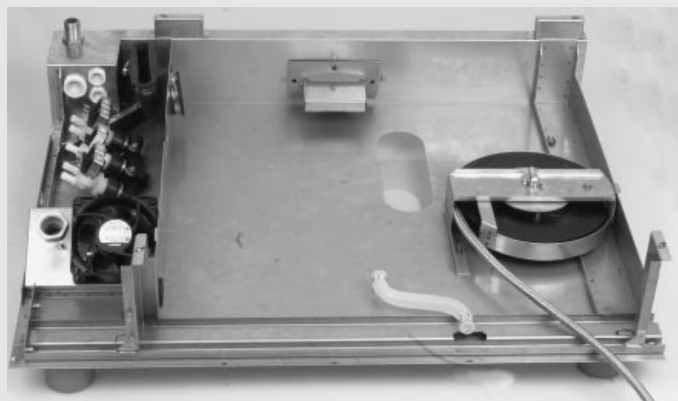

Pos. Pos.	St. Pcs.	Ersatz.Nr. Sp. Part No.	Bezeichnung	Description
1	1	2910.1203	Entlüftungsrohr	Venting pipe quenching chamber
2	1	2118.1202	Manschette Entlüftungsrohr unten	Rubber form piece venting pipe up
3	2	2066.0524	Schlauschelle 90-110	Hose clamp 90-110
4	1	2118.1201	Manschette Entlüftungsrohr oben	Rubber form piece venting pipe down
-	1	8455.1207	Glockenhalter	Vent cover bracket
5	1	2066.0505	Schlauschelle 70-90mm	Hose clamp 70-90mm
-	1	2760.1253	Lochscheibe d64mm	Protection plate d64mm
6	1	1006.0764	Sechskantschraube M 6x25	Hexagonal screw M 6x25
7	1	1306.0120	Unterlegscheibe A6,4	Washer A6.4
8	1	8455.1215	Entlüftungsstutzen	Venting stud

Handbrause	Spannung	Baugruppe	Ausgabe	gültig ab Seriennummer
Hand shower	Voltage	Group	Edition	Applicable from Serial.No.
	3 N AC 400V 50Hz	11	11.1.2	C61C95057001

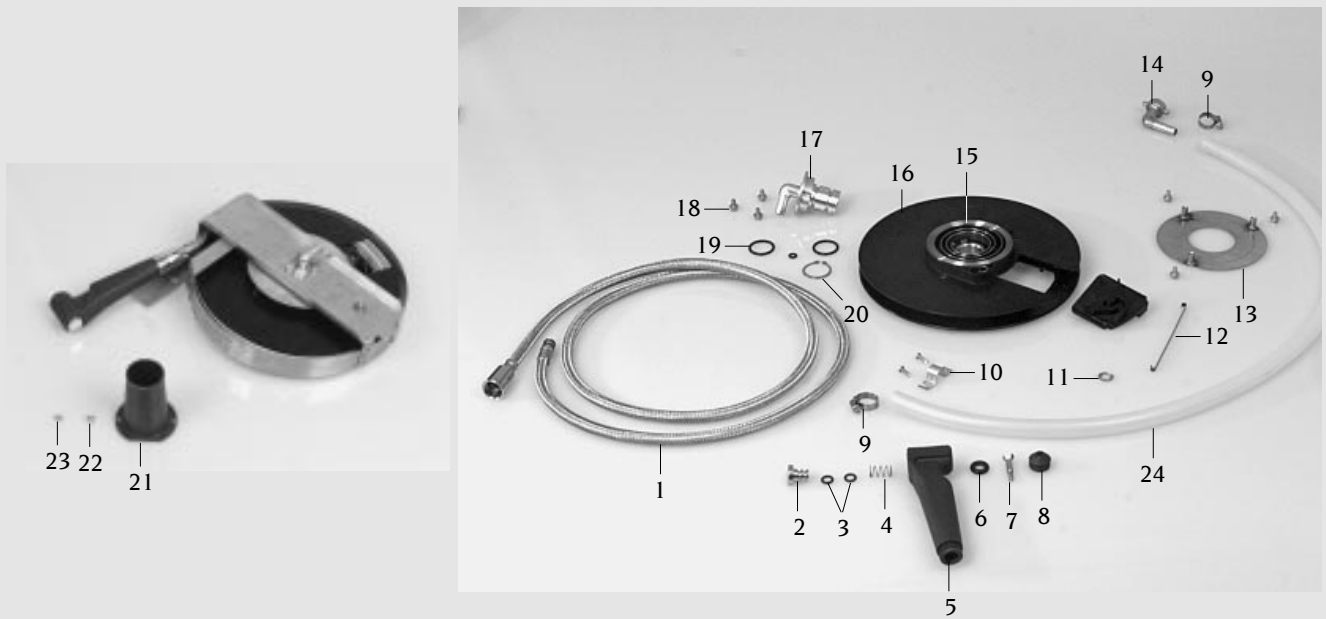

Pos.	St.	Ersatz.Nr.	Bezeichnung	Description
Pos.	Pcs.	Sp. Part No.		
-	1	8655.2006	Schlauchroller kpl.	Hand shower roll guide
1	1	2067.0605	Brauseschlauch 1500 mm	Shower hose 1500 mm
-	2	2060.0228	O-Ring für Brauseschlauch	O-ring for shower hose
2	1	2060.1001	Druckknopf für Handbrause	Push-button for hand shower
3	2	5012.0559	O-Ring f. Schlauchbrause d 7x2,5mm	O-ring for hand shower d 7x2,5mm
4	1	2001.0110	Druckfeder f. Schlauchbrause	Compression spring for hand shower
5	1	2060.1000	Handbrause	Hand shower
6	1	5012.0558	O-Ring f. Schlauchbrause d 8x5mm	O-ring for hand shower d 8x5mm
7	1	2060.1003	Steilkegelstift Handbrause	Steep taper pin for hand shower
8	1	2060.1002	Düse f. Handbrause	Nozzle for hand shower
9	2	2066.0205	Schlauchschele 12-18mm	Hose clamp 12-18mm
10	1	2760.1159	Befestigungsschele	Fixing clip
-	2	1003.0231	Kerbschraube 3,9x13 mm	Slotted screw 3.9 x 13 mm
11	1	2001.0203	Federmutter d 8mm	Spring nut d 8 mm
12	1	2001.0202	Bügfeder f. Schlauchroller	Return spring for hose roll guide
13	1	8655.2005	Haltescheibe für Spiralfeder	Locking disc for spiral coiled spring
14	1	2062.0208	Winkelverschraubung G1/2"x10"	Elbow screw point G1/2"x10"
-	1	5012.0539	Dichtung für Verschraubung G 1/2"	Gasket for G1/2" threaded joint
15	1	2001.0201	Spiralfeder f. Schlauchroller	Spiral coiled spring for hose roll guide
16	1	2060.0150	Schlauchrad für Handbrause	Retractable wheel for hand shower
17	1	2060.0157	Achse für Schlauchroller	Axle for hose roll
18	3	1005.2000	Sperrzahnschraube M 5x8	Interlocking tooth screw M 5x8
19	1	8000.0081	Satz O-Ring	Set O-ring
20	1	1250.0103	Sicherungsring 28mm	Guard ring 28mm
21	1	2060.1200	Aufnahme für Handbrause	Hand shower intake
22	2	1304.0150	Unterlegscheibe A3,2	Washer A3,2
23	2	1103.0120	Sechskantmutter M 3	Hexagonal nut M3

