



# Spare Parts for Combi Ovens



Spare parts suitable for

# ALTOSHAAM

# 2017

Find the complete and up-to-date range of products in our GEV Webshop



## heating elements

## heating cables

## miscellaneous



<b>GEV No.</b>	580139	<b>Ref. No.</b>	4878
<b>description</b>	heating cable kit		



<b>GEV No.</b>	420280	<b>Ref. No.</b>	4881 CB-3045
<b>description</b>	heating cable kit L 210Ft~64008mm for heated cabinet		



<b>GEV No.</b>	580006	<b>Ref. No.</b>	4880
<b>description</b>	heating cable L 134Ft~40843mm		

## heating cartridges



<b>GEV No.</b>	419035	<b>Ref. No.</b>	CB-3538
<b>description</b>	heating cartridge 230W 240V ø 12.5mm L 112mm thread 5/8"-18UNF cable length 150mm		

## accessories

## washers



<b>GEV No.</b>	560112	<b>Ref. No.</b>	WS-22295
<b>description</b>	plain washer ID ø 5.3mm ED ø 10mm thickness 1mm SS Qty 20 pcs DIN 125A for thread M5		



<b>GEV No.</b>	560113	<b>Ref. No.</b>	WS-22297
<b>description</b>	plain washer ID ø 6.4mm ED ø 12mm thickness 1.6mm SS Qty 20 pcs DIN 125A for thread M6		

## thermostats

## bi-metal thermostats

## safety bi-metal thermostats



<b>GEV No.</b>	390991	<b>Ref. No.</b>	TT-3859
<b>description</b>	bi-metal safety thermostat hole distance 23.5mm switch-off temp. 150°C 1CO 1-pole 16A 250V connection F6.3 screw		

## control and safety thermostats

## EGO

## safety thermostats

## 55.32\_ series



<b>GEV No.</b>	375474	<b>Ref. No.</b>	TT-33325
<b>description</b>	safety thermostat t.max. 340°C switch-off temp. 340°C 2-pole 1NC/1CO 1x20/1x0.5A probe ø 4mm probe L 120mm capillary pipe 1300mm capillary pipe isolated 900mm gland nut probe		



INVENSYS / ROBERTSHAW

control thermostats



<b>GEV No.</b>	390992	<b>Ref. No.</b>	TT-3978
<b>description</b>	thermostat t.max. 121.111°C temperature range 15.55-121.11°C 1-pole 1NO 16A probe ø 5mm probe L 400mm capillary pipe 850mm capillary pipe isolatedmm gland nut shaft ø 6x4.6mm shaft L 21mm shaft position lower rotation 315° 60-250°F		



<b>GEV No.</b>	390875	<b>Ref. No.</b>	TT-3498
<b>description</b>	thermostat t.max. 232.2°C temperature range 37.77-232.22°C 1-pole 1NO 30A probe ø 5mm probe L 280mm capillary pipe 900mm capillary pipe isolatedmm gland nut shaft L 24mm rotation 315° 100-450°F t.max. 450°F		



<b>GEV No.</b>	580075	<b>Ref. No.</b>	TT3057 TT3058
<b>description</b>	thermostat t.max. 93°C temperature range 15-93°C 1-pole 1NO 15A probe ø 5mm probe L 400mm capillary pipe 1000mm capillary pipe isolatedmm gland nut shaft ø 6x4.6mm shaft L 22mm operating temperature range 60-200°F		



<b>GEV No.</b>	390993	<b>Ref. No.</b>	TT-33432
<b>description</b>	thermostat t.max. 93°C temperature range 15-93°C 1-pole 1NO 15A probe ø 5mm probe L 400mm capillary pipe 2100mm capillary pipe isolatedmm gland nut shaft ø 6x4.6mm shaft L 22mm operating temperature range 60-200°F		

various

control thermostats

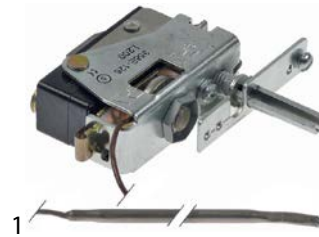

<b>GEV No.</b>	390994	<b>Ref. No.</b>	TT-33626
<b>description</b>	thermostat t.max. 121.11°C temperature range adjustable°C 1-pole 1NO 16A probe ø 4mm probe L 250mm capillary pipe 2140mm capillary pipe isolatedmm gland nut shaft ø 6x4.6mm shaft L 21mm shaft position° shaft position right rotation°		
<b>For models:</b>	750-S-HD		



<b>GEV No.</b>	580008	<b>Ref. No.</b>	TT3329
<b>description</b>	thermostat temperature range 37.77-162.78°C probe ø 5mm probe L 300mm capillary pipe 950mm shaft ø 6x4.6mm shaft L 23mm operating temperature range 100-325°F		

switches and momentary switches

rocker/momentary rocker switches

28x13.5mm



<b>GEV No.</b>	348099	<b>Ref. No.</b>	SW-3409
<b>description</b>	rocker switch mounting measurements 27.4x12.4mm black 1CO 250V 10A with neutral position connection male faston 6.3mm ambient temperature max. 85°C protection IP40		



30x22mm



1

<b>GEV No.</b>	301004	<b>Ref. No.</b>	SW-3887
<b>description</b>	rocker switch mounting measurements 30x22mm black 2CO 250V 16A connection male faston 6.3mm ambient temperature max. 125/55°C protection IP40		
<b>accessories for</b>	301004		
	<b>GEV No.</b>	301036	<b>Ref. No.</b> —
	protective cover internal size 30x22mm for rocker switch mounting measurementsmm		



1

<b>GEV No.</b>	346377	<b>Ref. No.</b>	SW-34788
<b>description</b>	rocker switch mounting measurements 30x22mm black 2CO 230V 16A 0-1 connection male faston 6.3mm ambient temperature max. 125/55°C protection IP40		
<b>accessories for</b>	346377		
	<b>GEV No.</b>	301036	<b>Ref. No.</b> —
	protective cover internal size 30x22mm for rocker switch mounting measurementsmm		

37x21mm



1

<b>GEV No.</b>	347969	<b>Ref. No.</b>	SW-34769
<b>description</b>	rocker switch mounting measurements 37x21mm black 2NO 250V 10A 0-1 connection male faston 6.3mm ambient temperature max. 85°C protection IP44		



1

<b>GEV No.</b>	348153 <sup>1</sup>	<b>Ref. No.</b>	5010847
<b>description</b>	rocker switch mounting measurements 37x21mm black 2NO 250V 10A 0-1 connection male faston 6.3mm ambient temperature max. 85°C protection IP44 mounting frame inclusive		

<sup>1</sup>with accessories

## toggle switches

M12x0.75



1

<b>GEV No.</b>	348151	<b>Ref. No.</b>	SW-3040
<b>description</b>	toggle switch 2NO 250V screw		



1

<b>GEV No.</b>	348154	<b>Ref. No.</b>	SW-3041
<b>description</b>	toggle switch thread M10x0.75 1NO 120-240V 12/20A ON-OFF screw		

## lamps

## indicator lights

## indicator lights (complete)

ø12mm

## with plug-in socket



1

<b>GEV No.</b>	580014	<b>Ref. No.</b>	LI3025 LI3027
<b>description</b>	indicator light ø 12mm 230V red		

30x13mm



1

<b>GEV No.</b>	346547	<b>Ref. No.</b>	LI-3516
<b>description</b>	indicator light mounting measurements 27.4x12.4mm 230V red connection male faston 6.3mm temp.-resist. 120°C		

## screw-on/push-on fit

## halogen lamp

## for socket G4 / G6.35 / G9



1

<b>GEV No.</b>	357193	<b>Ref. No.</b>	LP-34213
<b>description</b>	halogen lamp socket G4 12V 20W temp.-resist. 300°C OSRAM HALOSTAR OVEN		





oven lamps

universal oven lamps

55x70mm

1



<b>GEV No.</b>	359297	<b>Ref. No.</b>	CV-26607	
<b>description</b>	frame L 95mm W 81mm mounting distance 68/83mm thickness 6mm			
<b>accessories for</b>	359297			
	<b>GEV No.</b>	359299	<b>Ref. No.</b>	GS-26609
	 gasket L 91mm W 77mm hole ø 3mm for oven lamp			

1



<b>GEV No.</b>	359299	<b>Ref. No.</b>	GS-26609
<b>description</b>	gasket L 91mm W 77mm hole ø 3mm for oven lamp		

lamps

halogen lamps

for socket G4 / G6.35 / G9

1



<b>GEV No.</b>	357193	<b>Ref. No.</b>	LP-34213
<b>description</b>	halogen lamp socket G4 12V 20W temp.-resist. 300°C OSRAM HALOSTAR OVEN		

timers

electric timers

1



<b>GEV No.</b>	580007	<b>Ref. No.</b>	TR3318
<b>description</b>	timer 240V operation time 12h		

contactors

HARTLAND

power contactors

1



<b>GEV No.</b>	381284	<b>Ref. No.</b>	CN-3062
<b>description</b>	power contactor resistive load 40A 208/240VAC 30A/10HP (AC3/240V) 30A/7.46kW main contacts 3NO auxiliary contacts connection screw clamp/male faston 6.3mm type HCCY3XU02CY		

SPRECHER+SCHUH

power contactors

1



<b>GEV No.</b>	381396	<b>Ref. No.</b>	CN-3654
<b>description</b>	power contactor resistive load 32A 220VAC (AC3/400V) 20A/11kW main contacts 3NO auxiliary contacts 1NC connection screw type CA7-23-01		

solid state relays

CRYDOM

1



<b>GEV No.</b>	403662	<b>Ref. No.</b>	RL-3736
<b>description</b>	solid state relay CRYDOM 1 phase 25A 240V 90-280VAC L 57mm W 44.6mm screw connection type A2425		





miscellaneous





1

<b>GEV No.</b>	403789	<b>Ref. No.</b>	RL-3583
<b>description</b>	solid state relay TELEDYNE 25A 12-280V 4-30VDC L 58mm W 44mm screw type S24D25		



1

<b>GEV No.</b>	372018	<b>Ref. No.</b>	VA-34300
<b>description</b>	solenoid valve single straight 230VAC inlet 3/4" outlet 14mm DN10 EATON (INVENSYS) flow regulating valve outlet flow regulating valve inlet white		
<b>spare parts for</b>	372018		
	<b>GEV No.</b>	371122	<b>Ref. No.</b> —
	solenoid valve filter ø 19mm H 10mm suitable for MÜLLER		
	<b>GEV No.</b>	371131	<b>Ref. No.</b> —
	solenoid coil 230VAC		

probes

producer-specific probes

probes



1

<b>GEV No.</b>	379800	<b>Ref. No.</b>	5002100
<b>description</b>	temperature probe thermocouple K (NiCr-Ni) cable silicone probe -50 up to 1150°C cable -50 up to +180°C connection 2-wire thread M5 probe ø4x20mm cable length 3m		
<b>accessories for</b>	379800		
	<b>GEV No.</b>	521012	<b>Ref. No.</b> —
	gasket graphite ED ø 15mm ID ø 5mm thickness 1.2mm Qty 1 pcs		



1

<b>GEV No.</b>	378507	<b>Ref. No.</b>	PR-33751
<b>description</b>	temperature probe thread M5 cable length 3m		

solenoid valves

solenoid valves (water)

ROBERTSHAW/INVENSYS

medium temperature: 90°C 90°C 60°C  
 ambient temperature: 60°C 25°C 60°C  
 duty cycle: 40% 100% 100%



1

<b>GEV No.</b>	372022	<b>Ref. No.</b>	VA-34045
<b>description</b>	solenoid valve double straight 230VAC inlet 3/4" outlet 14mm DN10 EATON (INVENSYS)		



fans

axial fans

import



1

<b>GEV No.</b>	601080 <sup>1</sup>	<b>Ref. No.</b>	FA-3568
<b>description</b>	axial fan L 119mm W 119mm H 38mm 230VAC 50/60Hz 23/20W bearing ball bearing connection male faston 2.8mm metal ADDA fan wheel ø 110mm temp.-resist. 70°C		
<b>accessories for</b>	601080		
	<b>GEV No.</b>	550898	<b>Ref. No.</b> —
	connecting cable cable length 2000mm connection F 2.8 connection distance 7.9mm for axial flow fan		
	<b>GEV No.</b>	692519	<b>Ref. No.</b> —
	guard L 120mm W 120mm plastic		

<sup>1</sup>with ball bearings



## ignition parts

### pilot burners

#### HONEYWELL

#### pilot burners



1

**GEV No.** 102490 **Ref. No.** BN-33371

**description** pilot burner 1 flame

#### spare parts and accessories



Image not available

1

**GEV No.** 580002 **Ref. No.** HD2575

**description** counterpart

## knobs

### universal knobs

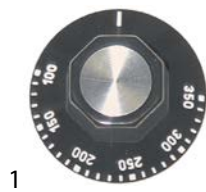

1

**GEV No.** 110124 **Ref. No.** KN3468

**description** knob thermostat t.max. 350°C t.max.°F 100-350°C°F ø 50mm shaft ø 6x4.6mm shaft flat upper black temperature range 100-350°C rotation 270°

**accessories for** 110124



**GEV No.** 110135 **Ref. No.** —

rosette knob up to ø 52mm

### producer-specific knobs

#### ALTO-SHAAM



1

**GEV No.** 110124 **Ref. No.** KN3468

**description** knob thermostat t.max. 350°C t.max.°F 100-350°C°F ø 50mm shaft ø 6x4.6mm shaft flat upper black temperature range 100-350°C rotation 270°

**accessories for** 110124



**GEV No.** 110135 **Ref. No.** —  
rosette knob up to ø 52mm



1

**GEV No.** 111491 **Ref. No.** KN-3474

**description** knob thermostat t.max. 90°C t.max.°F 15-90°C°F ø 48mm shaft ø 6x4.6mm shaft flat lower

**For models:** 750-S-HD



1

**GEV No.** 580011 **Ref. No.** KN3469

**description** knob thermostat t.max.°C t.max. 200°F°C 60-200°F ø 49mm shaft ø 6x4.6mm shaft flat lower

**For models:** 750-S-HD

locks

edgmount latches

magnetic locks

CHG

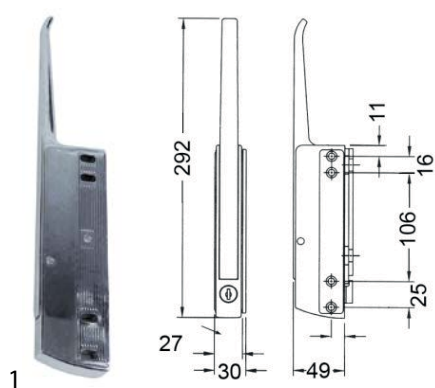

<b>GEV No.</b>	690208	<b>Ref. No.</b>	HD2007
<b>description</b>	magnetic lock L 168mm mounting distance 105/147mm non lockable refrigeration units R25		

hinges

edgmount hinges

CHG

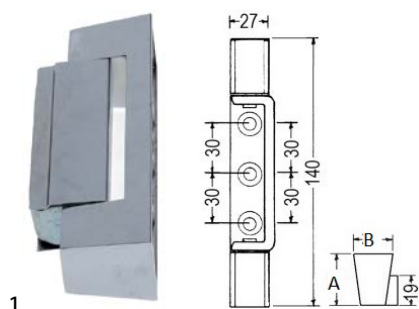

<b>GEV No.</b>	690294	<b>Ref. No.</b>	HG-2014
<b>description</b>	edgmount hinge L 140mm mounting distance 30/30mm hinging left/right without lift L1 33mm L2 30mm series R42		
<b>spare parts for</b>	690294		
	<b>GEV No.</b>	690292	<b>Ref. No.</b> —
	spring for R42 (140mm)		

miscellaneous



<b>GEV No.</b>	710031	<b>Ref. No.</b>	CS-25675
<b>description</b>	swivel castor with swivel brake ø 90mm square pipes housing chrome-plated sheet steel capacitykg spigot hight 56mm spigot-ø 35x35mm bearing slide bearing wheel body tread H 190mm wheel width 32mm Qty 1 pcs		

gaskets

gaskets for heated units

door seals

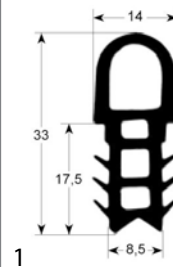

<b>GEV No.</b>	901675	<b>Ref. No.</b>	GS-25550
<b>description</b>	door seal profile 2060 W 420mm L 475mm external size Qty 1		

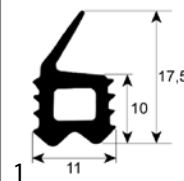

<b>GEV No.</b>	901312	<b>Ref. No.</b>	GS-23790
<b>description</b>	door seal profile 2708 W 385mm L 545mm external size		

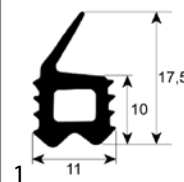

<b>GEV No.</b>	901313	<b>Ref. No.</b>	GS-23794
<b>description</b>	door seal profile 2708 W 500mm L 730mm external size		

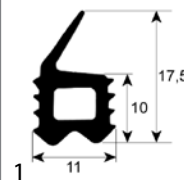

<b>GEV No.</b>	901132	<b>Ref. No.</b>	GS22903 GS-23778
<b>description</b>	door seal profile 2708 W 545mm L 590mm external size		
<b>For models:</b>	750-S-HD		

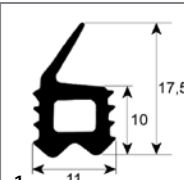

<b>GEV No.</b>	901314	<b>Ref. No.</b>	GS-23796
<b>description</b>	door seal profile 2708 W 560mm L 780mm external size		

mechanical components, equipment accessories



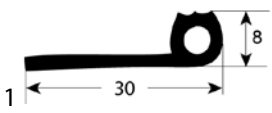



<b>GEV No.</b>	580013	<b>Ref. No.</b>	GS2398
<b>description</b>	door seal profile 2949 L 3000mm Qty 1		

## fittings, hose and pipe connectors

### hose connectors

#### nickel-plated brass



<b>GEV No.</b>	512440	<b>Ref. No.</b>	PB-26512
<b>description</b>	T-piece with probe connection nickel-plated brass thread 3/4" hose $\varnothing$ 16mm		

## measuring equipment

### thermometers

#### built-in thermometers

$\varnothing$ 41mm



<b>GEV No.</b>	541894	<b>Ref. No.</b>	TH-33713
<b>description</b>	thermometer mounting $\varnothing$ 41mm t.max. 105°C 0-105°C probe $\varnothing$ 9.5mm probe L 65mm capillary pipe 900mm		

$\varnothing$ 52mm



<b>GEV No.</b>	580016	<b>Ref. No.</b>	GU-33384
<b>description</b>	thermometer mounting $\varnothing$ 52mm t.max. 175°C +40 up to +175°C probe $\varnothing$ 11mm probe L 67mm capillary pipe 1800mm		

## fastening material

### screws

#### hexagonal screws



<b>GEV No.</b>	560084	<b>Ref. No.</b>	SC-26060
<b>description</b>	hexagonal screw thread M5 thread L 16mm SS WS 8 Qty 20 pcs DIN 933 / ISO 4017		



<b>GEV No.</b>	560088	<b>Ref. No.</b>	SC-22924
<b>description</b>	hexagonal screw thread M6 thread L 20mm SS WS 10 Qty 20 pcs DIN 933 / ISO 4017		

### nuts

#### hexagonal nuts

DIN 934 / ISO 4032/8673



<b>GEV No.</b>	511212	<b>Ref. No.</b>	NU-22291
<b>description</b>	hexagonal nut thread M6 H 5mm WS 10 SS DIN/ISO DIN 934 / ISO 4032/8673 Qty 1 pcs		

### washers

#### spring rings



<b>GEV No.</b>	560122	<b>Ref. No.</b>	WS-22301
<b>description</b>	lock washer ID $\varnothing$ 5.2mm ED $\varnothing$ 9mm SS DIN127 Qty 20 pcs for thread M5		



<b>GEV No.</b>	560123	<b>Ref. No.</b>	WS-22302
<b>description</b>	lock washer ID $\varnothing$ 6.3mm ED $\varnothing$ 11mm SS DIN127 Qty 20 pcs for thread M6		



washers

DIN 125A



1

<b>GEV No.</b>	560112	<b>Ref. No.</b>	WS-22295
<b>description</b>	plain washer ID ø 5.3mm ED ø 10mm thickness 1mm SS Qty 20 pcs DIN 125A for thread M5		



1

<b>GEV No.</b>	560113	<b>Ref. No.</b>	WS-22297
<b>description</b>	plain washer ID ø 6.4mm ED ø 12mm thickness 1.6mm SS Qty 20 pcs DIN 125A for thread M6		

<b>A</b>			
axial fans		6	
<b>B</b>			
bi-metal thermostats		2	
<b>C</b>			
castors and bumper angles		8	
contactors		5	
<b>D</b>			
door seals		8	
<b>E</b>			
edgemount hinges		8	
edgemount latches		8	
electric timers		5	
<b>F</b>			
fans		6	
fastening material		9	
<b>G</b>			
gaskets for heated units		8	
<b>H</b>			
halogen lamp		4	
heating cables		2	
heating cartridges		2	
heating elements		2	
hexagonal nuts		9	
hexagonal screws		9	
hose connectors		9	
<b>I</b>			
indicator lights		4	
indicator lights (complete)		4	
<b>L</b>			
lamps		4	
<b>M</b>			
magnetic locks		8	
measuring equipment		9	
<b>N</b>			
nuts		9	
<b>O</b>			
oven lamps		5	
<b>P</b>			
pilot burners		7	
probes		6	
<b>R</b>			
rocker/momentary rocker switches		3	
<b>S</b>			
safety bi-metal thermostats		2	
safety thermostats		2	
screws		9	
solenoid valves		6	
solid state relays		5	
spring rings		9	
switches and momentary switches		3	
<b>T</b>			
thermostats		2	
timers		5	
toggle switches		4	
<b>W</b>			
washers		10	