

ALTO SHAAM®
Combitherm®

Combination
Oven / Steamer

10•10 MARINE Electric ML



- **INSTALLATION**
- **OPERATION**
- **MAINTENANCE**



W164 N9221 Water Street • P.O. Box 450 • Menomonee Falls, Wisconsin 53052-0450 USA
PHONE: 262.251.3800 • 800.558.8744 USA/CANADA FAX: 262.251.7067 • 800.329.8744 U.S.A. ONLY
WEBSITE: www.alto-shaam.com

INSTALLATION	SERVICE SECTION
Delivery & Unpacking1	SERVICE VIEW • OVEN EXTERIOR34
Safety Procedures & Precautions2	SERVICE VIEW • OVEN INTERIOR35
Options & Accessories3	SERVICE VIEW • SIDE PANEL ACCESS36
Basic Installation Site Requirements4	
Ventilation Requirements4	
Positioning On Site5	
Installation Requirements6	
Assembly Requirements7	
Water Supply8	
Water Drainage9	
Stacking Installation10	
Restraint Requirements - Mobile10	
Electrical Installation11	
Additional Technical Data12	
↗ Instructions to be Provided to Owner/Operator13	
INSTALLATION CHECK LIST14	
↗ IMPORTANT SAFETY PRECAUTIONS . . .15	
↗ CONTROL PANEL IDENTIFICATION	
• Standard and Deluxe16	
• S Control18	
CLEANING & MAINTENANCE	PARTS LIST
Preventive Maintenance19	RECESSED DOOR AND EXTERIOR PARTS37
Routine Cleaning Requirements19	ELECTRICAL AND ELECTRONIC PARTS38
Steam Generator Flush	MECHANICAL PARTS40
• Standard and Deluxe20	PLUMBING PARTS41
Oven Cleaner Requirements21	S CONTROL PARTS42
Daily Oven Cleaning	
• S Control23	WIRING SCHEMATICS
• Standard and Deluxe24	
Decalcification	10•10ml43-46
• S Control26	WIRING DIAGRAMS
• Standard and Deluxe28	
Daily Gasket Cleaning30	S Control (ALL MODELS)47
↗ EMERGENCY OPERATION31	Transportation & Damage Claims48
↗ CONTROL RESET32	Limited Warranty48
↗ TROUBLESHOOTING32	

ALTO SHAAM® COMBITHERM® INSTALLATION

DELIVERY

This Alto-Shaam appliance has been thoroughly tested and inspected to insure only the highest quality unit is provided. Upon receipt, check for any possible shipping damage and report it at once to the delivering carrier. See *Transportation Damage and Claims section located in this manual.*

This appliance, complete with unattached items and accessories, may have been delivered in one or more packages. Check to ensure that all standard items and options have been received with each model as ordered.

Save all the information and instructions packed with the appliance. Complete and return the warranty card to the factory as soon as possible to assure prompt service in the event of a warranty parts and labor claim.

This manual must be read and understood by all people using or installing the equipment model. Contact the Alto-Shaam service department if you have any questions concerning installation, operation, or maintenance.

NOTE: All claims for warranty must include the full model number and serial number of the unit.

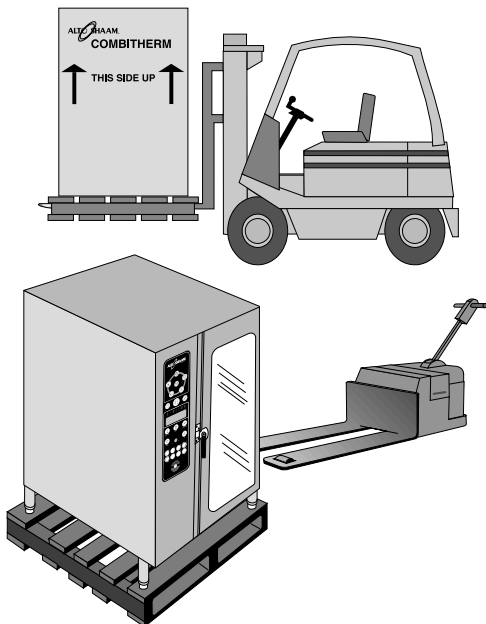

UNPACKING

1. Carefully remove the appliance from the carton or crate.

NOTE: Do not discard the carton and other packaging material until you have inspected the unit for hidden damage and tested it for proper operation.

2. **The oven must remain on the pallet while being moved to the installation site by fork lift or pallet lift truck.**

Note dimensions required for doorways and aisles for access of the oven and pallet to the installation site. Transport the oven in an upright and level position only. *Do not tilt the oven.*

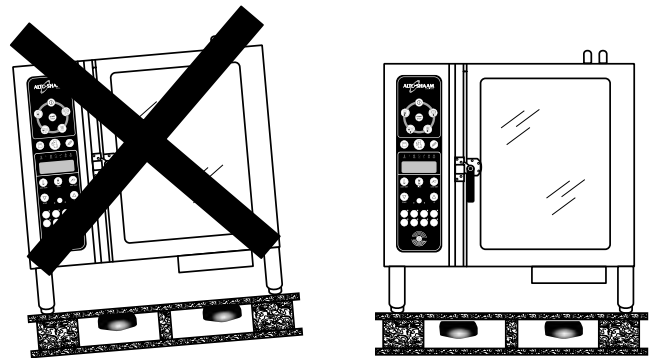

With the oven on the original pallet, remove the carton and all packaging materials. Open the oven door and remove all documents and other materials from the oven interior. Remove the roll-in cart if so equipped.

3. Read all instructions in this manual carefully before initiating the installation of this appliance.

DO NOT DISCARD THIS MANUAL.

This manual is considered to be part of the appliance and is to be provided to the owner or manager of the business or to the person responsible for training operators. *Additional manuals are available from the Alto-Shaam service department.*

4. Remove all protective plastic film, packaging materials, and accessories from the appliance before connecting electrical power. Store any accessories in a convenient place for future use.

SAFETY PROCEDURES AND PRECAUTIONS

Knowledge of proper procedures is essential to the safe operation of electrically and/or gas energized equipment. In accordance with generally accepted product safety labeling guidelines for potential hazards, the following signal words and symbols may be used throughout this manual.

 **DANGER** Used to indicate the presence of a hazard that **will** cause severe personal injury, death, or substantial property damage if the warning included with this symbol is ignored.

 **WARNING** Used to indicate the presence of a hazard that **can** cause personal injury, possible death, or major property damage if the warning included with this symbol is ignored.

 **CAUTION** Used to indicate the presence of a hazard that can or will cause minor or moderate personal injury or property damage if the warning included with this symbol is ignored.

CAUTION Used to indicate the presence of a hazard that can or will cause minor personal injury, property damage, or a potential unsafe practice if the warning included with this symbol is ignored.

NOTE: Used to notify personnel of installation, operation, or maintenance information that is important but not hazard related.

1. This appliance is intended to cook, hold or process foods for the purpose of human consumption. No other use for this appliance is authorized or recommended.
2. This appliance is intended for use in commercial establishments where all operators are familiar with the purpose, limitations, and associated hazards of this appliance. Operating instructions and warnings must be read and understood by all operators and users.
3. Any troubleshooting guides, component views, and parts lists included in this manual are for general reference only and are intended for use by qualified technical personnel.
4. This manual should be considered a permanent part of this appliance. This manual and all supplied instructions, diagrams, schematics, parts lists, notices, and labels must remain with the appliance if the item is sold or moved to another location.

COMBITHERM[®] OPTIONS & ACCESSORIES

OPTIONS & ACCESSORIES	
AutoClean™ A fully automated oven cleaning function with 4 levels of cleaning. (Not available on S-Control models).	
↳ FACTORY INSTALLATION ONLY	5001298
↳ CLEANER — FOUR (4) CONTAINERS/CASE; 1 GAL (C. 3,79 LITERS) EACH	CE-26013
↳ RINSE AGENT — FOUR (4) CONTAINERS/CASE; 1 GAL (C. 3,79 LITERS) EACH	CE-26014
CHICKEN GREASE TRAY WITH DRAIN: 1-1/2" (38mm) DEEP	4757
CHICKEN ROASTING RACKS:	
6 CHICKEN CAPACITY — FITS FULL-SIZE PAN: 3 RACKS PER OVEN	SH-23000
8 CHICKEN CAPACITY — FITS FULL-SIZE PAN: 3 RACKS PER OVEN	SH-23619
10 CHICKEN CAPACITY — FITS IN SIDE RACKS: 3 RACKS PER OVEN	SH-22634
DOOR, ANTI-SWING	CONTACT FACTORY
DOOR HINGING, LEFT HAND FACTORY INSTALLATION	
↳ OVERALL WIDTH DIMENSION INCREASES BY 1-1/2" (38mm)	FACTORY QUOTE
FRY BASKET, 12" x 20" (530mm x 325mm)	BS-26730
GRILLING GRATE, 12" x 20" (530mm x 325mm)	SH-26731
OVEN CLEANER — SPECIALLY FORMULATED FOR COMBITHERM OVENS	
↳ TWELVE (12) CONTAINERS/CASE, 1 QUART (C. 1 LITER) EACH	CE-24750
RACK MANAGEMENT TROLLEY SYSTEM INTERCHANGEABLE WITH QC-40 QUICKCHILLER & 10•18 WARMER	
↳ RACK-TRACK ASSEMBLY	14940
↳ SLIDE-IN-PAN RACK ASSEMBLY	15637
↳ TROLLEY BASE ASSEMBLY	15635
SECURITY DEVICES ITEMS AVAILABLE SEPARATELY — FACTORY INSTALLATION ONLY — PADLOCKS NOT INCLUDED	CONTACT
CONTROL SECURITY PANEL, DOOR LOCK, TAMPER-PROOF SCREW PACKAGE, FLANGED LEGS FOR FLOOR OR COUNTER BOLTING	FACTORY
SERVICE START-UP CHECK AVAILABLE THROUGH AN AUTHORIZED ALTO-SHAAM SERVICE TECHNICIAN	CONTACT FACTORY
SHELF, STAINLESS STEEL WIRE	SH-2903
STACKING HARDWARE:	
↳ 6•10 OVER 10•10, STATIONARY	5000495
↳ 6•10 OVER 10•10, MOBILE	5000627
STAND, STAINLESS STEEL:	
↳ STATIONARY: HEIGHT 27-3/4" (705mm) WITH SHELF	15964
↳ STATIONARY: HEIGHT 27-3/4" (705mm) WITH PAN SLIDES & SHELF	15960
↳ STATIONARY: HEIGHT 37-13/16" (960mm) OPEN TO FLOOR	15962
↳ MOBILE: HEIGHT 32-3/4" (832mm) WITH SHELF	15963
↳ MOBILE: HEIGHT 32-3/4" (832mm) WITH PAN SLIDES & SHELF	15961
VENTLESS HOOD FACTORY INSTALLATION ONLY	5000367
COMBIGUARD™ TRIPLE-GUARD WATER FILTRATION SYSTEM (INCLUDES 1 CARTRIDGE)	FI-23014
COMBIGUARD™ REPLACEMENT FILTER	FI-26356

COMBITHERM® INSTALLATION

BASIC INSTALLATION SITE REQUIREMENTS

HOOD INSTALLATION IS REQUIRED

- Installation surface must be level.
- Do not install adjacent to flammable surfaces.
- Deep fat fryers or similar heat producing equipment must not be installed in the immediate vicinity of the hand shower.



DANGER

DO NOT store or use any flammable liquids or allow flammable vapors in the vicinity of any appliance.

The oven must remain on the pallet while being moved to the installation site with fork lift or pallet lift truck.

Do not tilt the oven.

VENTILATION REQUIREMENTS

A steam ventilation hood is mandatory for the operation of the oven. The ventilation hood must be installed in accordance with local building codes for steam exhaust and must protrude 12-inches to 20-inches (300mm to 500mm) over the front side of the oven. A grease filter must be located in the protruding area of the hood. Grease filters should be thoroughly cleaned on a regular basis following manufacturer's instructions. Ventilation hoods must ensure an adequate amount of incoming air during operation and must be operated whenever the combination oven/steamer is used in order to avoid the accumulation of condensation in the hood area.

Where automatically operated appliances are vented through a ventilating hood or exhaust system equipped with a damper or with a power means of exhaust, provisions shall be made to allow the equipment to operate only when the damper is open to a position to properly vent the appliance and when the power means of exhaust is in operation.

IN ACCORDANCE WITH NFPA 54 COMMONWEALTH OF MASSACHUSETTS ONLY.

NOTE



If a ventless hood is to be installed, we recommend the Combitherm Ventless Hood for the appropriate model oven.

MODEL	VHML-10
Air Movement	1200 CFM
Drain Connection	3/4" (19,1mm) NPT
Electrical	208-240 V.A.C. — 50/60 Hz, 1 ph 240 watts, 1.0 amps
Ship Weight	126 lb (57 kg)
Replacement Filters	
GREASE	FI-23062
CHARCOAL	FI-24102

COMBITHERM® INSTALLATION

POSITIONING ON SITE

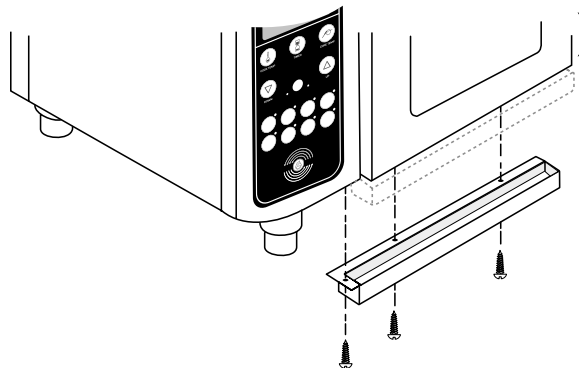

Before removing the oven from the pallet for positioning on site, it is important to remove the drip tray to prevent damage to the tray caused by the lifting forks. The drip tray is fastened to the bottom of the oven with three sheet metal screws as illustrated.

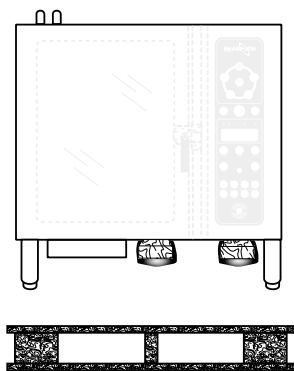
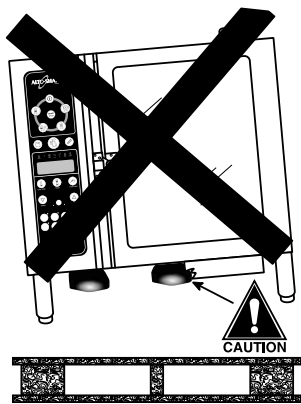

Lift the oven from the pallet with a fork lift or pallet lift truck positioned at the front of the oven. To avoid damage, position the lift forks to the left of the condenser as indicated in one of the two diagrams shown below. For additional damage protection, the use of two wooden boards, placed between the bottom of the oven and the lifting forks, is strongly recommended. After the oven is correctly positioned on site, reattach the drip tray.

OBSERVE ATTENTION LABEL ON OVEN FOR AREA TO AVOID WITH LIFTING FORK.

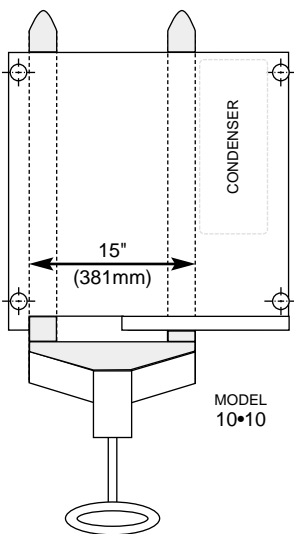

	CAUTION
	TO PREVENT PERSONAL INJURY, USE CAUTION WHEN MOVING OR LEVELING THIS APPLIANCE.

MODEL	NET WEIGHT
10•10	385 lb (175 kg)

PALLETIZED DIMENSIONS AND WEIGHT (EST.)				
MODEL	WIDTH	DEPTH	HEIGHT W/PALLET	WEIGHT W/PALLET
10•10 MARINE	60" (1524mm)	50" (1270mm)	49" (1245mm)	495 lb (225kg)

INSTALLATION REQUIREMENTS

- Do not install oven adjacent to flammable surfaces. Strictly observe all local fire safety regulations.
- In order to ensure proper ventilation, a minimum distance of at least 6-inches (152mm) must be kept from the control panel side [LEFT] of the oven and any adjoining surfaces.
NOTE: In addition to ventilation requirements, additional clearance is needed for service access. A minimum distance of 18-inches (457mm) is strongly recommended.
- Allow a minimum of 4-inches (102mm) from the right side of the oven to allow the door to open to at least a 90° angle. Fully opened, the door will extend up to a 225° angle. If the oven is furnished with the retractable door option, allow a minimum clearance of 6-1/2-inches (16cm).
- Allow a minimum clearance of 4-inches (102mm) from the back of the oven for plumbing connections.
- Allow a 20-inch (50cm) clearance at the top of the oven for free air movement and for the steam vent(s) located at the top [RIGHT-REAR].
- Do not install the oven adjacent to heat producing equipment such as fryers, broilers, etc. Minimum clearance recommended: 20-inches (50cm).

Place the Combitherm oven on a stable, **LEVEL** horizontal surface. For counter-top models, the oven stand must be level. In addition, the overall height of the oven should be positioned so the operating controls and shelves may be conveniently reached from the front.

ALL INSTALLATION INSTRUCTIONS AND REQUIREMENTS MUST BE STRICTLY OBSERVED.



IMPROPER CONNECTION OF THIS APPLIANCE NULLIFIES ALL WARRANTIES.

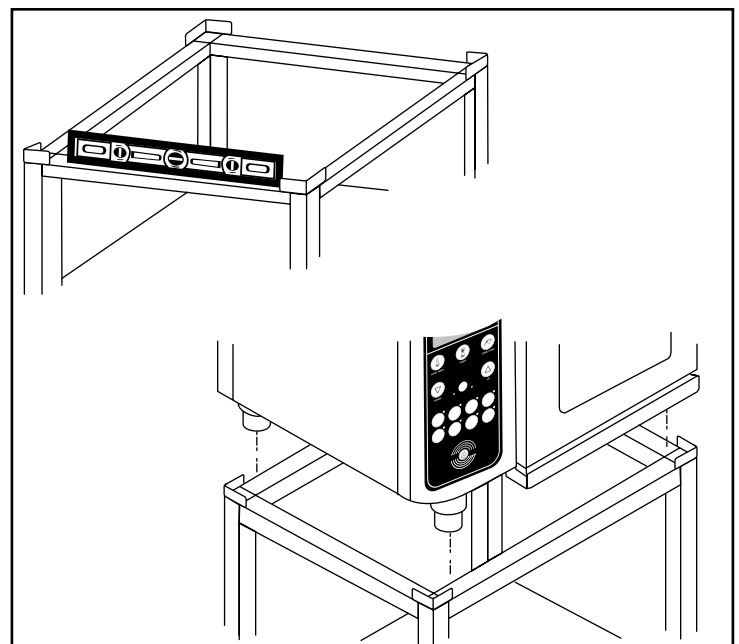
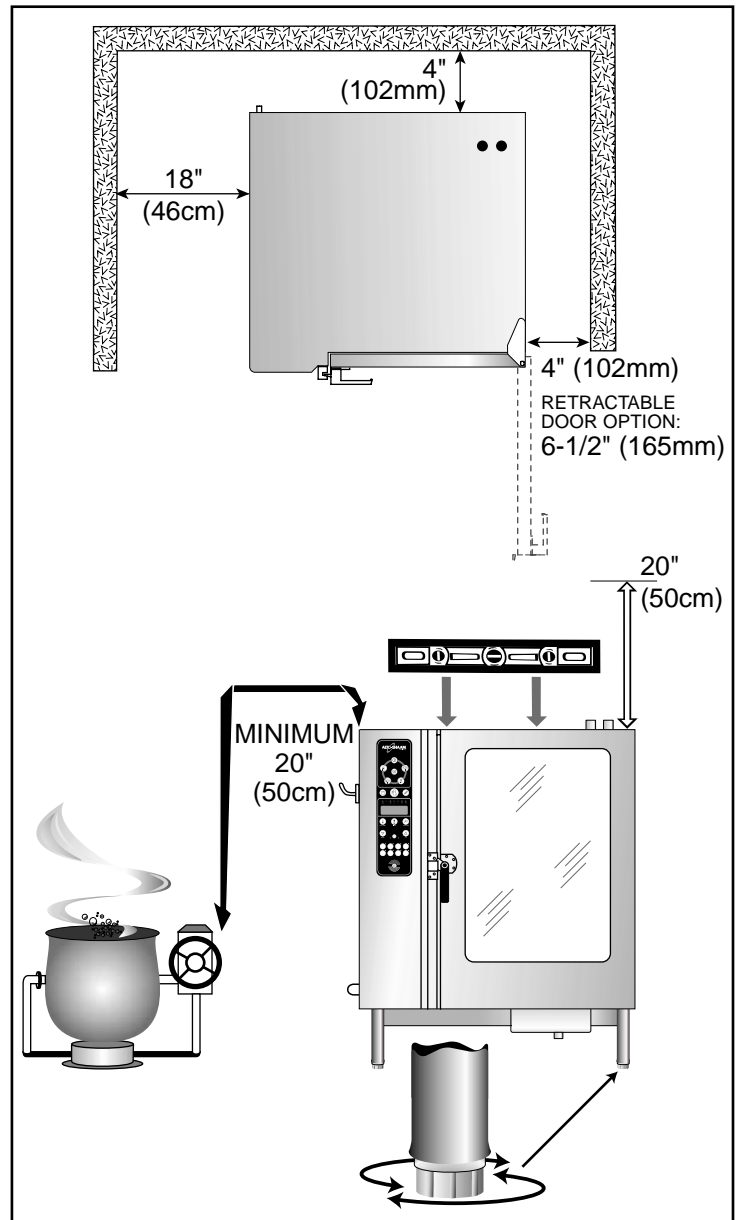

COMBITHERM® INSTALLATION

ASSEMBLY REQUIREMENTS

HAND SHOWER HOLDER

Fasten the hand shower holder in the holes provided on the oven using the three (3) screws packaged with the holder.

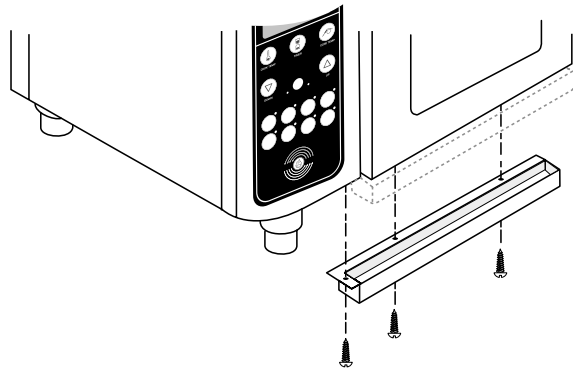
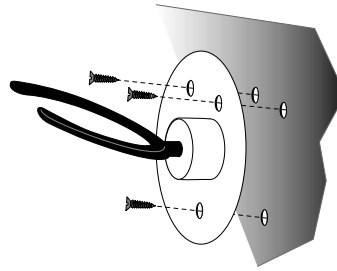

DRIP TRAY

Fasten the drip tray to the bottom of the oven using the three (3) screws as illustrated.

	WARNING
	<p>FAILURE TO PROPERLY INSTALL THE DRIP TRAY CAN OR WILL CAUSE MAJOR EQUIPMENT DAMAGE AND WILL RESULT IN A LEAKAGE HAZARD THAT CAN CAUSE PERSONAL INJURY.</p>

DIMENSIONS

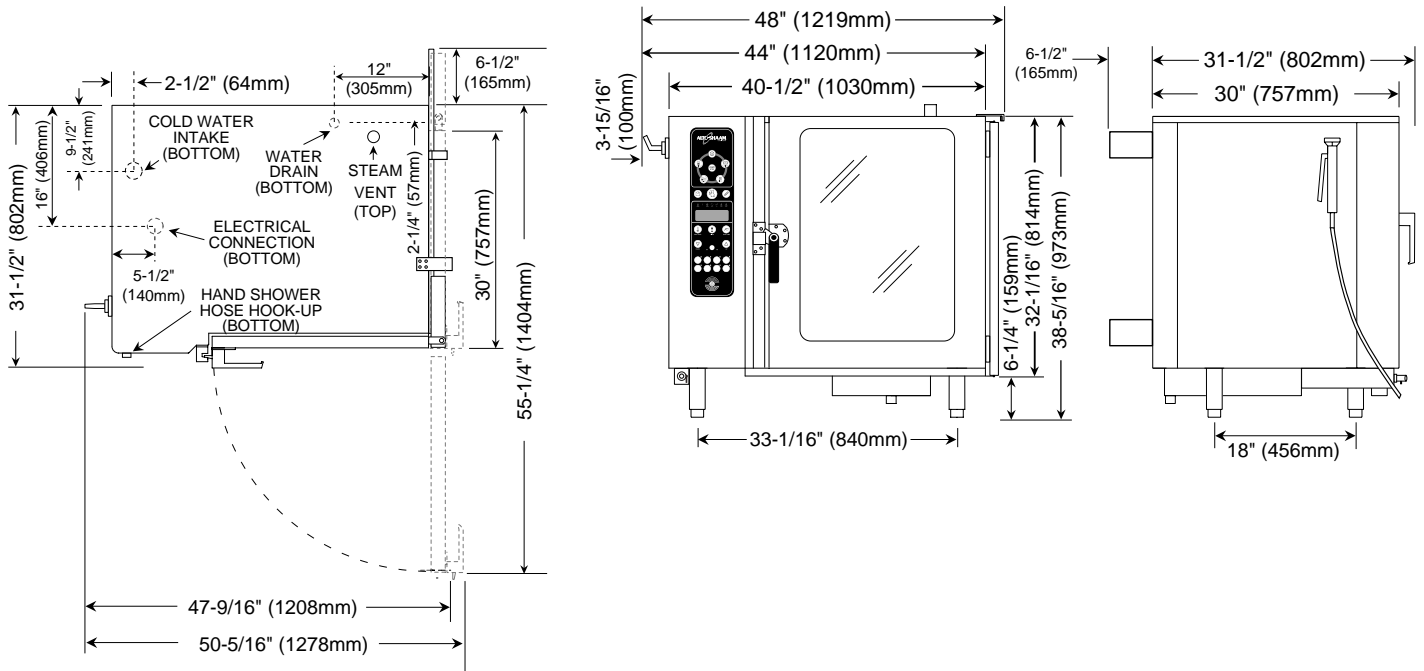

COMBITHERM® INSTALLATION

WATER SUPPLY

CONNECT TO POTABLE (DRINKABLE) COLD WATER ONLY

**WATER PRESSURE REQUIREMENTS: MINIMUM 30 PSI (2 BAR)
MAXIMUM 90 PSI (6 BAR)**

Flush the water line at the installation site before connecting the oven to the water supply. A shut-off valve and approved back-flow preventer must be installed when connecting the oven to the cold water intake. The water supply line must be a minimum of 3/4-inch (NPT) (19mm). A hose connector is supplied for flexible hose connection to the **COLD** water source. Connected water should test at hardness level of 5 to 9 grains per gallon (85 to 154 ppm). A water filtration system is recommended if the water supply is between 5 and 9 gpg of hardness. If water tests over 18 gpg of hardness (344 ppm), the installation of a water softener to maintain oven function is strongly recommended.

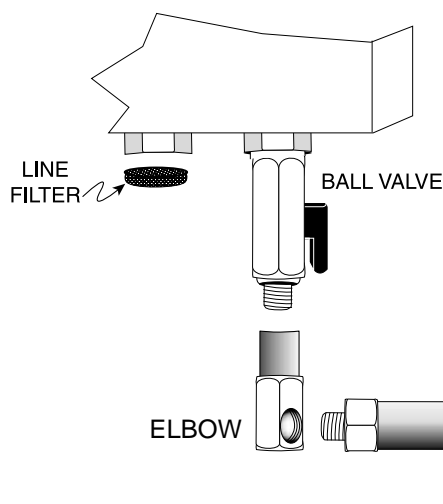

PIPE SEALING TAPE (TEFLON®) MUST BE USED AT ALL CONNECTION POINTS.

The use of a pipe sealing compound is not recommended.

THE SHUT-OFF VALVE MUST BE IN THE OPEN POSITION WHEN THE OVEN IS BEING USED.

WATER	
COLD WATER — DRINKING QUALITY	
INDIRECT WASTE PIPE WITH AIR GAP:	1-1/2" NPT
INLET: 3/4" NPT	LINE PRESSURE: 30 to 90 psi 2 to 6 bar
CHLORINE: less than 0.8 ppm	CHLORIDE: less than 70 ppm
HARDNESS: 5 to 9 gpg 85 to 154 ppm	PH RANGE: 7.0 to 9.0
WATER SOFTENER SHOULD BE UTILIZED IN HARD WATER AREAS.	

The hand shower spray hose is installed adjacent to the cold water intake connection. A ball valve is installed on the oven for hose connection to the **COLD** water source. Assemble the washer and the flexible hose on the ball valve and hang the spray handle on the holder previously installed on the oven.



ITEM FI-23014 Alto-Shaam now offers an improved water filtration system for Combitherm®. The CombiGuard™ triple-guard water filtration system filters dirt, sediment, and other debris as small as 1/2 micron. This system also significantly reduces chlorine content to protect against corrosive chlorine compounds. CombiGuard improves equipment efficiency, reduces service requirements and extends the life of the Combitherm. Filtration system includes one filter cartridge. Additional cartridges (**FI-26356**) can be purchased separately.

COMBITHERM® INSTALLATION

WATER DRAINAGE

The oven must discharge through an indirect waste pipe by means of an air gap. The drain thread is 1-1/4-inch (32mm) NPT.

A union is required. Install a 1-1/4-inch (32mm) diameter drain line. The drain line must always be a positive gradient away from the Combitherm oven and not more than 12-inches (305mm) before an air gap.

NOTE: In the U.S.A., this equipment is to be installed to comply with the Basic Plumbing Code of the Building Officials and Code Administrators International, Inc. [BOCA], and the Food Service Sanitation Manual of the Food & Drug Administration [FDA].

If several units are to be connected to one drain pipe, the dimensions of the pipe must be sufficient to allow an unobstructed water drain system.

AVERAGE DRAIN WATER TEMPERATURE
149°F (65°C)

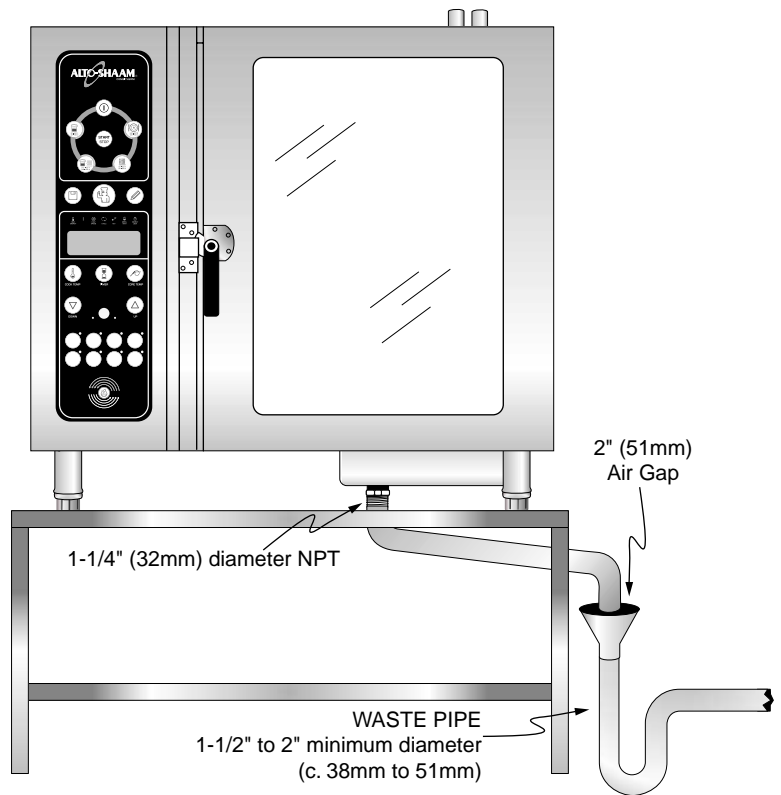

COMBITHERM® INSTALLATION

STACKING INSTALLATION

Stacking Combitherm ovens require two (2) water connections, two (2) drain connections, and two (2) electrical connections.

If local code allows, the water and drain may be manifolded as long as the size of the water inlet is increased to 1-inch (25,4mm) and the drains include an external vent. The drawing illustrates one suggested method of a manifold installation.

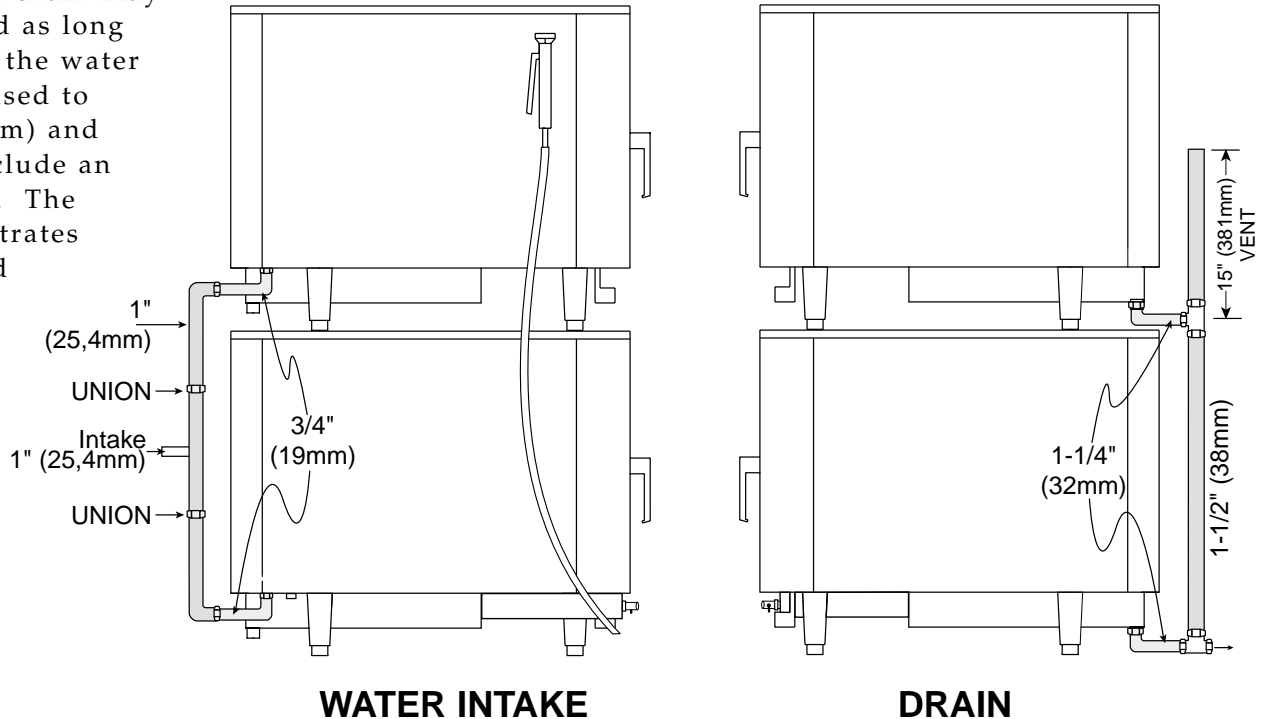

RESTRAINT REQUIREMENTS — MOBILE EQUIPMENT

Any appliance that is not furnished with a power supply cord but that includes a set of casters must be provided with a tether. Adequate means must be provided to limit the movement of this appliance without depending on or transmitting stress to the electrical conduit. The following requirements apply:

1. Casters must be a maximum height of 6" (152mm).
2. Two of the casters must be the locking type.
3. Such mobile appliances or appliances on mobile stands must be installed with the use of a flexible connector secured to the building structure.

A mounting connector for a restraining device is located on the lower back flange of the appliance chassis or on an oven stand, approximately 18" (457mm) from the floor. A flexible connector is not supplied by nor available from the factory.

	! WARNING
	RISK OF ELECTRIC SHOCK. Appliance must be secured to building structure.

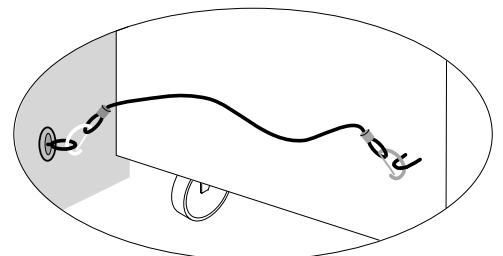

COMBITHERM® INSTALLATION

ELECTRICAL INSTALLATION

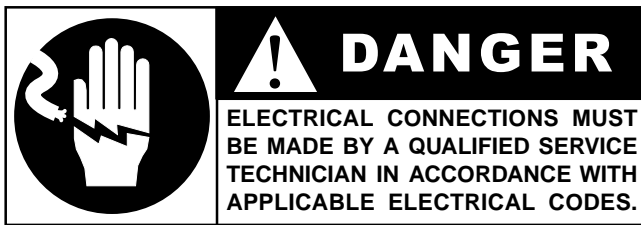

An electrical wiring diagram is located behind the control panel on the left side of the oven. The oven must be installed by a qualified electrician. This appliance must be branch circuit protected with proper ampacities, in accordance with the wiring diagram located in the electrical compartment of the oven. The oven must be properly grounded in accordance with the National Electrical Code and applicable local codes.

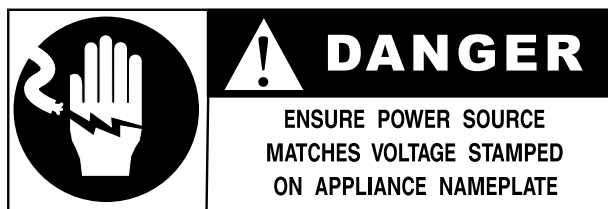

Wire size for the main incoming power to the unit must match the minimum size listed in the specifications applicable to the specific oven model. For supply connections, locate the wire size posted on the label located on the electrical control box cover, behind the service panel or elsewhere listed in this manual.

When connecting to a Delta-B (wild leg) on a 3-phase system, the wild leg must be connected to line 3.

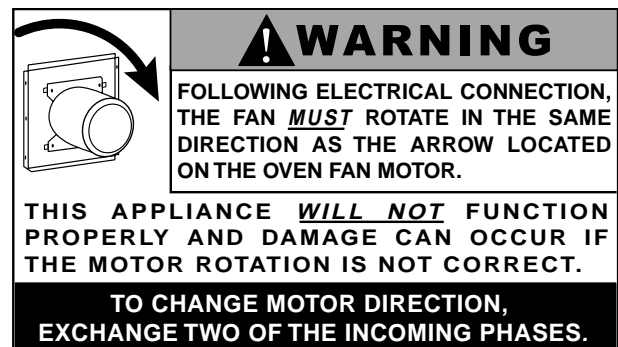
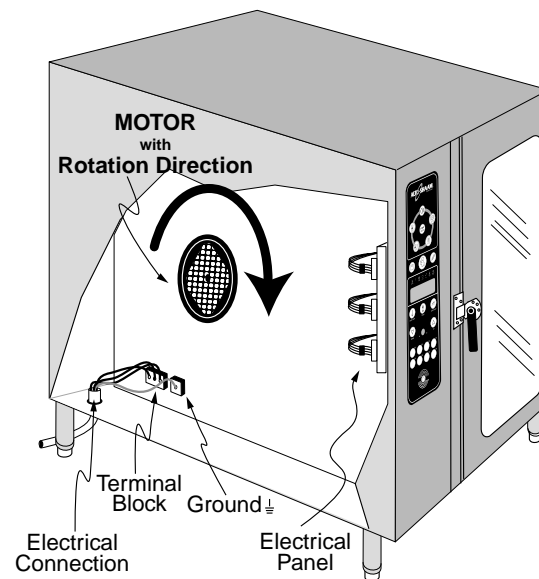
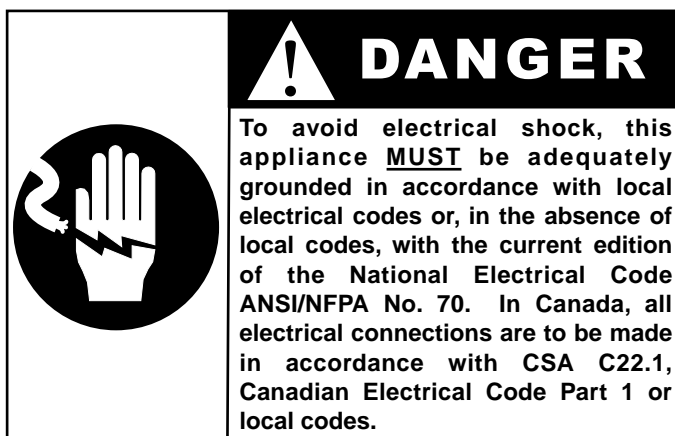

Before operating the oven, check all cable connections in the electrical connection area for tightness since connections can loosen during transport.

NOTE: After both water and electrical connections have been completed, operate the oven in any cooking mode for a period of 15 minutes and recheck the main power connections at the terminal block to make certain they remain tight.

ADDITIONAL TECHNICAL DATA

MODEL ⇔	10•10ML				
Type of Oven	counter oven stand				
Pan INCHES Capacity GASTRONORM	10: 12" x 20" 10: 18" x 13" 10: GN 1/1				
Side Rack INCHES Spacing (MILLIMETERS)	2-5/8 (65mm)				
Interior INCHES Width (MILLIMETERS)	23-1/2 (596)				
Interior INCHES Depth (MILLIMETERS)	21-1/16 (535)				
Interior INCHES Height (MILLIMETERS)	27 (685)				
Noise Level	The noise emission level related to the workplace is lower than: 70 dBA				
Spray Hose Length	81-inches (2050mm)				
Water Consumption (APPROX.)	8-13 gal/hr (30-50 l/hr)				
Steam Generator Water Consumption (APPROX.)	0.10 gal/min (0.4 l/min)				
Steam Generator Rating (APPROX.)	46.3 lb/hr (21 kg/hr)				
Steam Generator Volume GALLONS (LITERS)	2.6 (10)				
Radiated Heat Loss BTU/HR (KJ/H)	4419 (4666)				
Latent Heat Loss BTU/HR (kJ/h)	4909 (5184)				
Total Heat Loss BTU/HR (kJ/h)	9328 (9850)				
Air Circulation (WITH/WITHOUT HOOD) cubic feet/hr $\Delta T=8K$ (m ³ /h)	16951/13419 (480/380)				
Air Circulation (WITH/WITHOUT HOOD) cubic feet/hr $\Delta x=5g/kg$ (m ³ /h)	10594/7416 (300/210)				

COMBITHERM® INSTALLATION

INSTRUCTIONS TO BE PROVIDED TO OWNER/OPERATOR

INITIALS/DATE

- | | |
|--|--|
| <input type="checkbox"/> Owner/operator has been instructed on proper method of flushing the steam generator and safe procedures for handling the steam generator drain cap. | |
| <input type="checkbox"/> Owner/operator has been instructed on the importance of cleaning the oven along with proper cleaning procedures including automatic steam generator flush, daily cleaning of the interior, and monthly decalcification. | |
| <input type="checkbox"/> Owner/operator has been advised to use authorized Combitherm oven cleaner only. | |
| <input type="checkbox"/> Owner/operator has been informed of the safety warnings located in the operation guide including the warning not to handle pans containing liquid or semi liquid products positioned above eye level of the operator. | |



Damage directly attributed to improper set up, installation, or cleaning can invalidate warranty claims.



ELECTRIC COMBITHERM INSTALLATION CHECKLIST

Use this list as a final check of oven installation conformance. Damage directly attributed to improper set up, installation, or cleaning can invalidate warranty claims.

CLEARANCES:

All clearances must conform with the standards set by Alto-Shaam as indicated in the installation manual. Standards include a minimum 20" (50cm) clearance from any heat-producing device such as an open burner range, flat top grille, fryer, steamer, etc. Also make sure sufficient service access is provided on the left side of the oven. There must be an allowance of free air access to all vents.

RIGHT SIDE CLEARANCE: _____

LEFT SIDE CLEARANCE: _____

REAR CLEARANCE: _____

UPPER CLEARANCE: _____

WATER SUPPLY AND DRAINS:

Verify hook-up to **cold** water supply with a 3/4" (19mm) single water connection supply line. Verify inlet water pressure is at a minimum of 30 PSI (2 bar) for electric ovens. Maximum pressure is not to exceed 90 PSI (6 bar). Verify the installation of a water filter and the installation of a water conditioner if water supply is over 10 grains of hardness. Verify drain diameter of 1-1/4" (32mm) with a positive descending slope, and with a 2" (51mm) air gap which is free of obstructions before connection to the site drain. Verify 1/8" (3,2mm) pitch to 10' (305cm) of drain line. After pressure is adjusted, seal screw with enamel such as nail polish.

WATER SUPPLY LINE DIA: _____

COLD WATER: YES NO

WATER INLET PRESSURE: _____

DRAIN LINE DIA: _____

2" (51mm) AIR GAP: YES NO

ELECTRICAL CONNECTIONS:

Verify electrical power requirements for oven. Verify voltage at terminal block. Verify correct power cable size. Verify equipment disconnect per NEC or applicable local codes. Motor direction should correspond with the direction of the arrow on the motor. Verify clockwise motor rotation from the rear of the motor. Check all terminals for tightness.

VOLTAGE: _____

PHASE: _____

LINE VOLTAGE AT TERMINAL BLOCK (TO GROUND):

➔ LINE 1: _____ LINE 2: _____ LINE 3: _____

LINE VOLTAGE (PHASE TO PHASE): LINE 1 to 2: _____

LINE 2 to 3: _____

LINE 3 to 1: _____

ELECTRICAL SUPPLY LINE SIZE: _____

CORRECT MOTOR ROTATION: YES NO

ALL ELECTRICAL TERMINALS TIGHT: YES NO

CONTROL BOARD CONNECTIONS & OPERATION:

Verify all control board connections are tight including tightness and proper connection of ribbon/computer cables. Verify all buttons and lights illuminate. With the Power Key OFF, press and hold the Chef Function Key to access software version, and record. Verify all functions operate.

ALL BOARD CONNECTIONS TIGHT: YES NO

ALL FUNCTIONS LIGHT UP: YES NO

ALL FUNCTIONS OPERATE: YES NO

SOFTWARE VERSION:

BM _____ SM _____ KM _____

PHYSICAL CONDITION:

- Bottom of oven has been checked for damage due to improper positioning on site.
- Verify all gaskets, hoses, and carts are in place and function properly.
- If oven includes a cart, verify proper installation of the rack guide.
- Verify the installation of drip pans, racks, shelves, drain screen, spray hose.
- Verify the oven is level and installed on a solid, water resistant floor.

SERVICE AGENCY: _____ START-UP DATE: _____

TECH _____ CUSTOMER _____

SIGNATURE: _____ SIGNATURE: _____

IMPORTANT SAFETY PRECAUTIONS



CAUTION
STEAM

For safe release of the cooking compartment steam, initially open the door approximately 2" (50mm) only. Stand behind the door as the hot steam is released.

DO NOT USE THE ATTACHED HAND-HELD HOSE TO SPRAY ANYTHING OTHER THAN THE INTERIOR OF THE COMBITHERM OVEN COMPARTMENT. AT NO TIME SHOULD THE EXTERIOR OF THE OVEN BE STEAM CLEANED, HOSED-DOWN WITH THE HAND-SPRAYER, FLOODED WITH WATER, OR FLOODED WITH LIQUID SOLUTION OF ANY KIND.

DO NOT USE THE SPRAY HOSE IN A HOT COOKING COMPARTMENT. ALLOW THE OVEN TO COOL TO A MINIMUM OF 150°F (66°C).

DO NOT USE HIGH PRESSURE WATER CLEANING METHODS ON THE INTERIOR OR EXTERIOR OF THE COMBITHERM OVEN.

DO NOT HANDLE PANS CONTAINING LIQUID OR SEMI LIQUID PRODUCTS POSITIONED ABOVE EYE LEVEL OF THE OPERATOR. SUCH PRODUCTS CAN SCALD AND CAUSE SERIOUS INJURY.

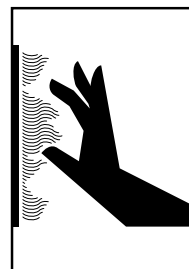

CAUTION

METAL PARTS OF THIS EQUIPMENT BECOME EXTREMELY HOT WHEN IN OPERATION. TO AVOID BURNS, ALWAYS USE HAND PROTECTION WHEN OPERATING THIS APPLIANCE.

USE AUTHORIZED COMBITHERM LIQUID OVEN CLEANER ONLY.

UNAUTHORIZED CLEANING AGENTS MAY DISCOLOR OR HARM INTERIOR SURFACES OF THE OVEN. READ AND UNDERSTAND LABEL AND MATERIAL SAFETY DATA SHEET BEFORE USING THE OVEN CLEANER.

FOR OPERATOR SAFETY

NOTE AND OBSERVE ALL SAFETY PRECAUTIONS LOCATED THROUGHOUT THIS MANUAL.

CONTROL PANEL IDENTIFICATION

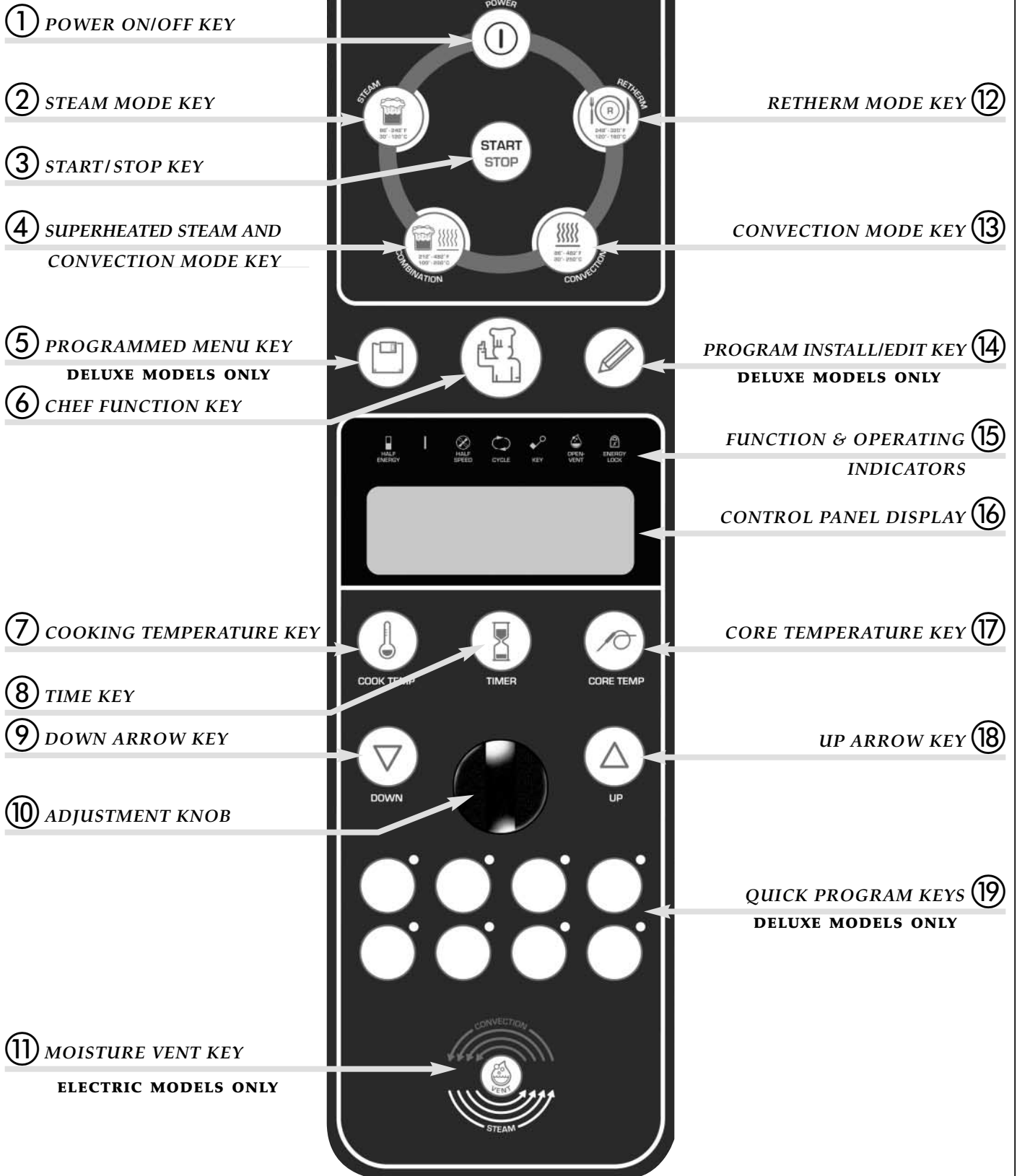

CONTROL PANEL IDENTIFICATION

- ① **POWER ON/OFF KEY**
 Activates power to the oven and automatically fills the steam generator with water which will heat to a stand-by mode temperature of 150°F (65°C). The steam generator flush is also activated by pressing this key.
- ② **STEAM MODE KEY**
 The oven will operate in the steam mode at a temperature range of 86°F to 248°F (30°C to 120°C).
- Automatic steaming at 212°F (100°C) **FACTORY-SET DEFAULT.**
 - Quick steaming between 213°F and 248°F (101°C and 120°C).
 - Low Temperature Steaming between 86°F and 211°F (30°C and 99°C).
- ③ **START/STOP KEY**
 Initiates all cooking mode functions and programmed procedures stored in memory. Stops an activated cooking mode or programmed procedure currently in progress, and exits Chef function key.
- ④ **SUPERHEATED STEAM AND CONVECTION MODE KEY**
 Selection key for the combination steam and convection cooking mode which can be set within a temperature range of 212°F to 482°F (100°C and 250°C).
- ⑤ **PROGRAMMED MENU KEY**
 Shows a list menu in display ⑯ of all stored cooking programs and is also used to exit the list menu display. **DELUXE MODELS ONLY.**
- ⑥ **CHEF FUNCTION KEY**
 Used to select programmed menu functions, various auxiliary functions, and several chef help instructions.
- ⑦ **COOKING TEMPERATURE KEY**
 Used to set the required cooking temperature, to recall the set cooking temperature, or to check the actual oven temperature in conjunction with the down arrow key ⑨, the up arrow key ⑱ or the adjustment knob ⑩.
- ⑧ **TIME KEY**
 Used to set the required cooking time or recall the set cooking time in conjunction with the down arrow key ⑨, the up arrow key ⑱ or the adjustment knob ⑩.
- ⑨ **DOWN ARROW KEY**
 Used to decrease displayed cook temperature ⑦, time ⑧, or core temperature ⑰ and as a scrolling key for programming functions.

- ⑩ **ADJUSTMENT KNOB**
 Serves the same function as the up and down arrow keys to increase or decrease the displayed cook temperature ⑦, time ⑧, or core temperature ⑰.
- ⑪ **MOISTURE VENT KEY** **ELECTRIC MODELS ONLY**
 Immediately vents steam and condensate from the oven compartment while cooking in the Convection mode ⑬ or in the Superheated Steam and Convection mode ④.
- ⑫ **RETHERM MODE KEY**
 Food rethermalization or reheating mode will operate with automatic steam injection at a temperature range of 248°F and 320°F (120°C and 160°C).
- ⑬ **CONVECTION MODE KEY**
 Selection key for convection cooking without steam at a temperature range of 86°F to 482°F (30°C and 250°C).
- ⑭ **PROGRAM INSTALL AND EDIT KEY**
 Used to create, change, duplicate, and delete programmed menus. **DELUXE MODELS ONLY.**

⑮ FUNCTION & OPERATING INDICATORS

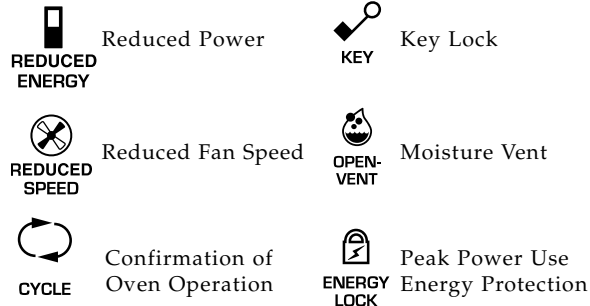

⑯ CONTROL PANEL DISPLAY

- ⑰ **CORE TEMPERATURE KEY**
 Used to set the required internal product temperature, to recall the internal product temperature set by the operator, or to display the current internal temperature of the product in conjunction with the down arrow key ⑨, the up arrow key ⑱ or the adjustment knob ⑩.
- ⑱ **UP ARROW KEY**
 Used to increase displayed cook temperature ⑦, time ⑧, or core temperature ⑰ and as a scrolling key for programming functions.
- ⑲ **QUICK PROGRAM KEYS**
 Immediate access to frequently used operator set programs including cooking modes, cleaning, and other oven functions. **DELUXE MODELS ONLY.**

S-CONTROL PANEL IDENTIFICATION



① OFF POSITION

Maintains oven in a stand-by mode.

② STEAM

The oven will operate at a fixed steam temperature of 212° F (100°C).

③ COMBINATION

A combination of steam and convection heat to cook at a temperature between 86°F and 482°F (30°C to 250°C) to be set by the operator.

④ CONVECTION

Convection heat to cook without steam at a temperature between 86°F and 482°F (30°C and 250°C) to be set by the operator.

⑤ LOW STEAM

Low temperature steaming within an operator set temperature range of 86°F to 210°F (30°C and 99°C).

⑥ CLEANING FUNCTION

An automatic cleaning cycle to heat the oven to the correct temperature, followed by a manual application of Combitherm Liquid Oven Cleaner and a 10 minute steam cleaning cycle. An automatic boiler flush is initiated on boiler equipped models and a vinegar decalcification can also be conducted.

⑦ COOKING TEMPERATURE DIAL

To be manually set by the operator to the cooking temperature required.

⑧ OVEN DISPLAY

Indicates time remaining or interior oven temperature.

⑨ COOKING TIMER

- ⊖ Turned to the left for continuous cooking time or to decrease time in increments of one minute.
- ⊕ Turn to the right to set and increase time in increments of one minute.

⑩ OVEN TEMPERATURE

To be pressed to display interior oven temperature.

⑪ FULL SPEED FAN POSITION

⑫ HALF SPEED FAN POSITION

⑬ OVEN COOL-DOWN POSITION

Assists in cooling the oven at an accelerated pace when changing from high to lower temperature cooking. **The oven door should be open when using this feature.**

Preventive Maintenance

In addition to the routine cleaning and maintenance procedures, there are several additional steps to be taken for both sanitation purposes and to keep the oven running at top operating efficiency. These additional safeguards will help prevent inconvenient down time and costly repairs.

- **DO NOT DISPOSE OF GREASE, FAT, OR SOLID WASTE DOWN THE OVEN DRAIN.**

Fats and solids will eventually coagulate in the drain system, causing blockage. Consequently, water will back-up into the condenser and interior oven compartment, resulting in an oven that is inoperable.

- **MAKE CERTAIN THE DRAIN SCREEN IS ALWAYS IN PLACE. REMOVE ANY SOLID WASTE MATERIAL FROM THE DRAIN SCREEN BEFORE IT ENTERS THE DRAIN SYSTEM.** The routine removal of solids from the drain screen will help prevent blockage.

- **USE THE AUTHORIZED COMBITHERM OVEN CLEANER ONLY.** The use of unauthorized cleaning agents may discolor or harm the interior surfaces of the oven.

- **TO PROLONG THE LIFE OF THE DOOR GASKET, REMOVE AND CLEAN THIS ITEM DAILY.** The acids and related compounds found in fat, particularly chicken fat, will considerably weaken the composition of the gasket unless cleaned on a daily basis.

- **TO ADDITIONALLY PROTECT GASKET LIFE, ALLOW OVEN DOOR TO REMAIN SLIGHTLY OPEN AT THE END OF THE PRODUCTION DAY.** An open door will relieve the pressure on the door gasket.

- **ROUTINELY CLEAN DOOR HINGES.** Open oven door to relieve tension. Clean all parts of the hinge.



Routine Cleaning Requirements

DAILY OVEN CLEANING

To be performed at the end of each production day or between production shifts.

DAILY STEAM GENERATOR FLUSH

When operating the oven on a regular basis, the steam generator must be flushed once a day. This procedure will prevent lime deposits and scale build-up from forming in the steam generator. A steam generator flush is automatically initiated during the cleaning function on S-control models.

REGULAR DECALCIFICATION

It is VERY important to decalcify the steam generator, particularly in areas with extremely hard water. This procedure should be performed once a month, or more frequently depending on usage and water conditions in addition to the daily steam generator flush.

AUTOMATIC STEAM GENERATOR FLUSH

STANDARD CONTROL
DELUXE CONTROL

AT THE START OF
EACH WORK DAY

STANDARD CONTROL
DELUXE CONTROL

Flushing the electric Combitherm steam generator on a daily basis helps to prolong the life of the steam generator heating elements and helps prevent the necessity of service requirements. The control provides this feature as an automatic function when the oven ON/OFF power key is pressed to the ON position at the start of each working day.

① PRESS THE ON/OFF POWER KEY TO THE ON POSITION AT THE START OF THE DAY.

DISPLAY MESSAGE INDICATES:

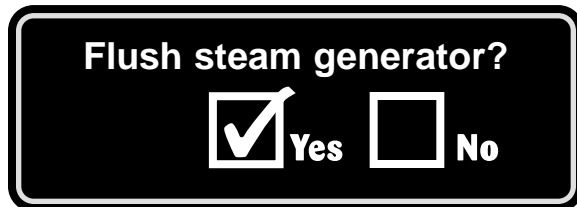

YES

PRESS THE START KEY  OR  CHEF FUNCTION KEY TO BEGIN THE STEAM GENERATOR FLUSH.

The steam generator is automatically drained, flushed, and refilled with water within 5 minutes or less. Following this time period, the Combitherm is ready for operation.

NO

TO CANCEL THE STEAM GENERATOR FLUSH, ROTATE THE ADJUSTMENT KNOB ONE TURN TO THE RIGHT UNTIL "NO" IS HIGHLIGHTED IN THE DISPLAY.

PRESS THE START KEY  OR  CHEF FUNCTION KEY TO CONFIRM CANCELLATION.

If steam generator flush cancellation is not initiated within 10 seconds of the appearance of the display message, the flushing function will automatically start. Following cancellation, the Combitherm is ready for operation. The flushing process *must* be initiated manually at a later time during the working day if not conducted at startup.

MANUAL STEAM GENERATOR FLUSH

PERFORM DAILY WHEN THE STEAM GENERATOR FLUSH IS NOT PERFORMED AT THE START OF THE WORKING DAY.

WITH THE OVEN AT ROOM TEMPERATURE

1. Press the Power Switch to the OFF position, rotate the Steam Generator Drain Cap located at the back of the oven until water begins to flow from the four holes in the cap. In approximately 20 to 60 seconds, a sufficient quantity of water will have drained from the steam generator so that the drain cap can be completely removed.
2. As the water continues to flow from the generator, it will have a milky or cloudy appearance, which indicates deposits in the generator are beginning to flush through the system. Let the water continue to drain until the flow begins to subside.
3. When the flow begins to subside, remove the hand-held hose from the side of the oven and direct a stream of fresh water directly into the steam generator drain opening located directly behind Steam Generator Drain Cap. Repeat this procedure several times until the water begins to run clear.
4. Press the oven Power Switch to the ON position. When the audible signal is heard, press the Steam Mode Key. A new supply of fresh, cold water will begin to flow through the steam generator. Repeat this procedure several times until the water runs completely clear.
5. Once the water is completely clear, replace the Steam Generator Drain Cap over the steam generator drain by turning it clockwise, by hand, until there is a slight resistance.

DO NOT OVER-TIGHTEN STEAM GENERATOR DRAIN CAP.

10•10 MARINE COMBITHERM ELECTRIC INSTALLATION AND MAINTENANCE MANUAL

CLEANING AND PREVENTIVE MAINTENANCE

PROTECTING STAINLESS STEEL SURFACES



It is important to guard against corrosion in the care of stainless steel surfaces. Harsh, corrosive, or inappropriate chemicals can completely destroy the

protective surface layer of stainless steel. Abrasive pads, steel wool, or metal implements will abrade surfaces causing damage to this protective coating and will eventually result in areas of corrosion. Even water, particularly hard water that contains high to moderate concentrations of chloride, will cause oxidation and pitting that result in rust and corrosion. In addition, many acidic foods spilled and left to remain on metal surfaces are contributing factors that will corrode surfaces.

Proper cleaning agents, materials, and methods are vital to maintaining the appearance and life of this appliance. Spilled foods should be removed and the area wiped as soon as possible but at the very least, a minimum of once a day. Always thoroughly rinse surfaces after using a cleaning agent and wipe standing water as quickly as possible after rinsing.

CLEANING AGENTS

USE AUTHORIZED COMBITHERM LIQUID OVEN CLEANER ONLY

Unauthorized cleaning agents may discolor or harm interior surfaces of the oven. Read and understand label and material safety data sheet before using the oven cleaner.

CLEANING MATERIALS

The cleaning function can usually be accomplished with the proper cleaning agent. When more aggressive methods must be employed, use a non-abrasive scouring pad on difficult areas and make certain to scrub with the visible grain of surface metal to avoid surface scratches. Never use wire brushes, metal scouring pads, or scrapers to remove food residue.



	<p>CAUTION</p> <p>TO PROTECT STAINLESS STEEL SURFACES, COMPLETELY AVOID THE USE OF ABRASIVE CLEANING COMPOUNDS, CHLORIDE BASED CLEANERS, OR CLEANERS CONTAINING QUATERNARY SALTS. NEVER USE HYDROCHLORIC ACID (MURIATIC ACID) ON STAINLESS STEEL. NEVER USE WIRE BRUSHES, METAL SCOURING PADS OR SCRAPERS.</p>
---	--

COMBITHERM® CLEANING & MAINTENANCE



RUBBER GLOVES AND PROTECTIVE EYE WEAR MUST BE WORN WHEN USING THE OVEN CLEANER.

USE AUTHORIZED COMBITHERM LIQUID OVEN CLEANER ONLY



Unauthorized cleaning agents may discolor or harm interior surfaces of the oven. Read and understand label and material safety data sheet before using the oven cleaner.

Causes severe burns. Do not get in eyes, on skin, or on clothing. Do not wear contacts. Harmful or fatal if swallowed. Do not breathe mist. Use in well ventilated area. Keep out of reach of children. Do not use on aluminum. Do not mix with anything but water.

S-CONTROL

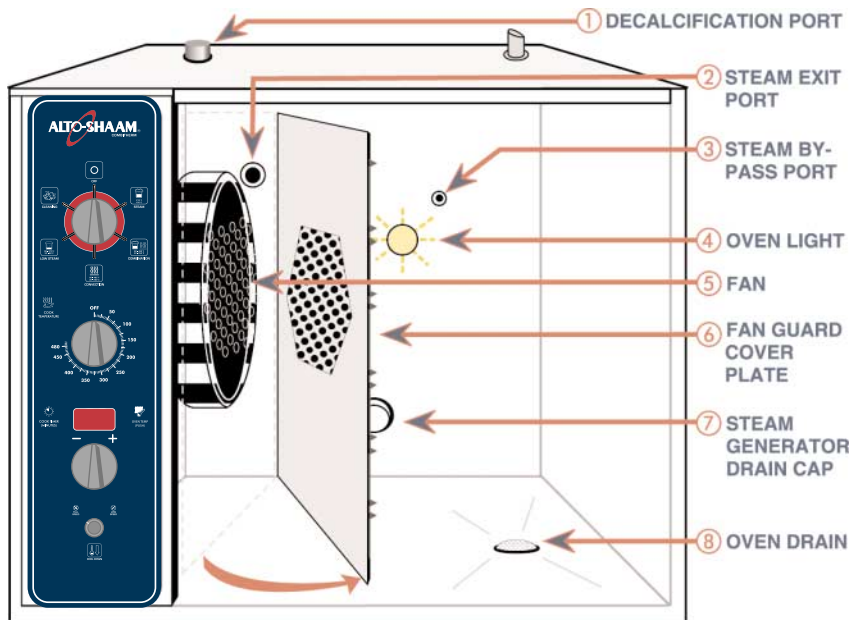

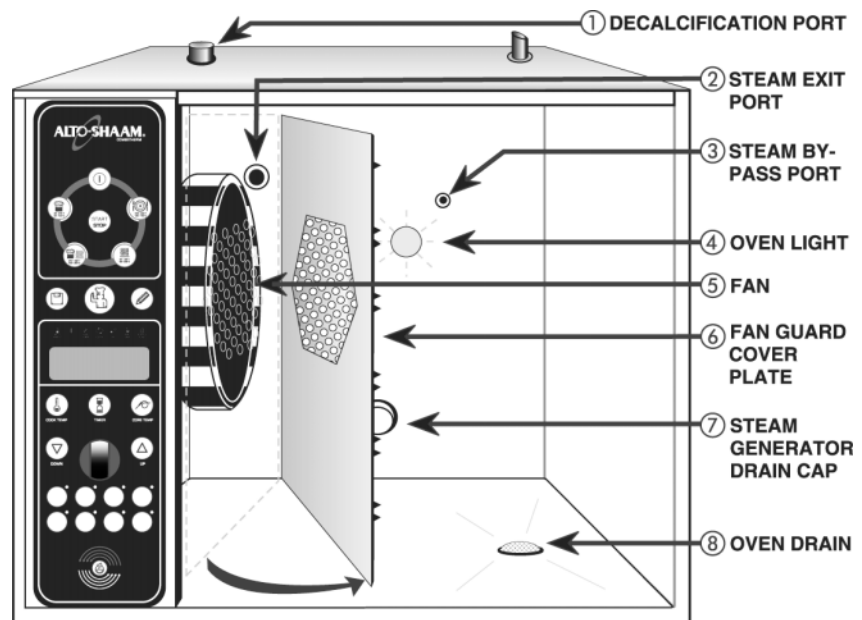

THOROUGHLY RINSE EMPTY CONTAINER WITH WATER AND SAFELY DISCARD.

**STANDARD CONTROL
DELUXE CONTROL**



DAILY OVEN CLEANING

The Combitherm automatic cleaning function selects the proper temperature for each step of the cleaning process.

1.  Remove all food scraps and residue from the oven drain.
Close the oven door securely.
Rotate the power knob to the cleaning symbol. 

THE OVEN WILL BEGIN THE FIRST STEP IN A TWO-STEP CLEANING CYCLE

• **10 MINUTES** at a steam temperature of 86°F (30°C)

2.  When the buzzer signals the end of the first step, open the oven door to deactivate the audible signal. **Cln** will appear in the display.
3. Wearing safety glasses and rubber gloves, remove the drain screen and spray Combitherm liquid oven cleaner directly into the oven drain ⑧. Replace the drain screen.
4. Generously spray the interior oven surfaces with an even coat of Combitherm Liquid Oven Cleaner. Spray all built-in components, shelves, side racks, and pans.
5. Loosen the thumb screw(s) and swing Fan Guard Cover Plate ⑥ toward the back of the oven. Spray the back of the Fan Guard Cover Plate, the oven fan ⑤, and the left-hand side of the oven. Close the swing-out Cover Plate ⑥. Lock the cover into place and tighten thumb screw(s).
6. Insert the Combitherm Liquid Oven Cleaner spray nozzle directly into the Steam By-Pass Port ③ and spray several times.
7. Securely close the oven door.

THE OVEN WILL BEGIN THE SECOND STEP IN THE TWO-STEP CLEANING CYCLE

• **10 MINUTES** at a steam temperature of 86°F (30°C)

8.  When the buzzer signals the end of the second step, open the oven door to deactivate the audible signal.
9. Use the hand held hose and direct a stream of water into the Steam By-Pass Port ③ to rinse away oven cleaner residue.
10. Rinse the interior and all sprayed components with the hand-held hose. Make certain to thoroughly rinse all surfaces to remove any cleaning solution residue. Use a non-abrasive cleaning pad for any problem areas.
11. Loosen the thumb screw(s) and swing Fan Guard Cover Plate toward the back of the oven. Thoroughly rinse the back of the Fan Guard Cover Plate, the oven fan, and the left-hand side of the oven. Close the swing out Cover Plate. Lock the cover into place and tighten thumb screw(s).

LEAVE DOOR SLIGHTLY OPEN AFTER CLEANING

COMBITHERM® CLEANING & MAINTENANCE

STANDARD CONTROL
DELUXE CONTROL

DAILY OVEN CLEANING

STANDARD CONTROL
DELUXE CONTROL

**DO NOT SPRAY CLEANER
INTO A HOT OVEN.**

ALLOW THE OVEN TO COOL TO 150°F (60°C).

The temperature in the display indicates the air temperature inside the oven compartment and not the interior walls of the oven. Always make certain to allow the oven walls to cool to a minimum of 150°F (60°C) before spraying the compartment with oven cleaner.

1. Remove all food scraps and residue from the oven drain ⑧.
2. Wearing safety glasses and rubber gloves, remove the drain screen and spray Combitherm liquid oven cleaner directly into the oven drain ⑧. Replace the drain screen.
3. Generously spray the interior oven surfaces with an even coat of Combitherm Liquid Oven Cleaner. Spray all built-in components, shelves, side racks, and pans.
4. Loosen the thumb screw(s) and swing Fan Guard Cover Plate ⑥ toward the back of the oven. Spray the back of the Fan Guard Cover Plate, the oven fan ⑤, and the left-hand side of the oven. Close the swing out Cover Plate ⑥. Lock the cover into place and tighten thumb screw(s).
5. Insert the Combitherm Liquid Oven Cleaner spray nozzle directly into the Steam By-Pass Port ③ and spray several times.
6. Securely close the oven door.

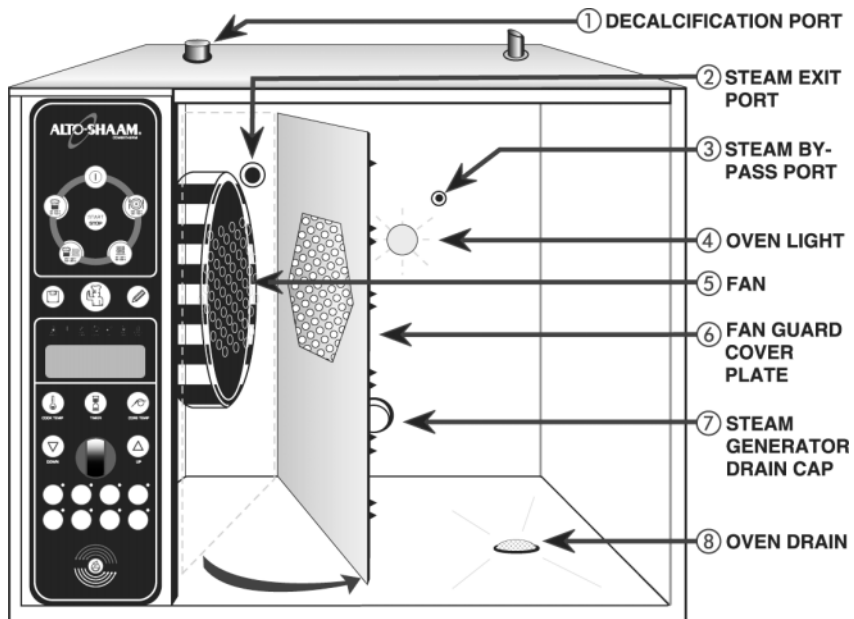

COMBITHERM® CLEANING & MAINTENANCE

AUTOMATIC CLEANING PROGRAM

**STANDARD CONTROL
DELUXE CONTROL**

The Combitherm automatic cleaning function selects the proper temperature for each step of the cleaning process.

With the oven power  on:

 PRESS THE CHEF FUNCTION KEY.

➔ Rotate the adjustment knob until the clean symbol  is highlighted in the display.

 PRESS THE CHEF FUNCTION KEY.

➔ Press the up Δ and down ∇ arrow keys or rotate the adjustment knob to select YES for the automatic cleaning function.

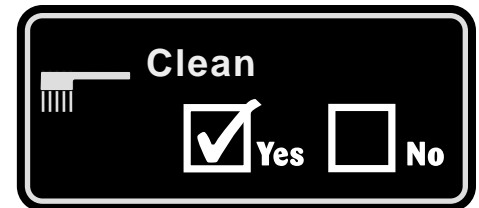

 PRESS THE CHEF FUNCTION KEY TO CONFIRM THE SETTING AND START THE CLEANING PROGRAM.

THE OVEN WILL BEGIN A 20 MINUTE, 2-STEP CLEANING CYCLE.

- 10 minutes at 86°F (30°C) to allow the cleaning agent to work
- 10 minutes at full steam temperature of 212°F (100°C) to clean the oven



FOR DELUXE OVENS WITH A PROGRAMMED MENU KEY

FOLLOW STEPS 1 THROUGH 6 ON THE PRECEDING PAGE.





With the oven power  on:

 ➔ PRESS THE PROGRAMMED MENU KEY.

Rotate the adjustment knob to program 250 = CLEAN.

 PRESS THE START KEY.

DELUXE MODELS CAN ALSO BE CLEANED AS SHOWN IN THE PREVIOUS INSTRUCTIONS.

7. When the buzzer signals the end of the cleaning process, press the start/stop key  to deactivate the audible signal or open the oven door.
8. With the door open, use the hand held hose and direct a stream of water into the Steam By-Pass Port  to rinse away oven cleaner residue.
9. Rinse the interior and all sprayed components with the hand-held hose. Make certain to thoroughly rinse all surfaces to remove any cleaning solution residue. Use a non-abrasive cleaning pad for any problem areas.
10. Loosen the thumb screw(s) and swing Fan Guard Cover Plate  toward the back of the oven. Thoroughly rinse the back of the Fan Guard Cover Plate, the oven fan, and the left-hand side of the oven. Close the swing out Cover Plate . Lock the cover into place and tighten thumb screw(s).

LEAVE DOOR SLIGHTLY OPEN AFTER CLEANING

COMBITHERM® DECALCIFICATION

CONTROL
S-OPTION

CONTROL
S-OPTION

It is **VERY** important to decalcify the oven, particularly in areas with extremely hard water.

PERFORM ONCE A MONTH
in addition to the daily steam generator flush.

WITH THE OVEN AT ROOM TEMPERATURE

1. Begin decalcification with the power switch in the OFF position.
2. Rotate the Steam Generator Drain Cap ⑦ until water begins to flow from the four holes in the cap. In approximately 20 to 60 seconds, a sufficient quantity of water will have drained from the steam generator so that the drain cap can be completely removed.
3. As the water continues to flow from the generator, it will have a milky or cloudy appearance, which indicates deposits in the generator system are beginning to flush out. Let the water continue to drain until the flow completely subsides. Replace the Steam Generator Drain Cap ⑦ by turning it clockwise until there is a slight resistance.
4. Unscrew the cap from the Decalcification Port ①. With the use of a funnel, pour one-half gallon (c. 2 liters) of distilled white vinegar into the Decalcification Port.
5. Replace the cap on the Decalcification Port ① and tighten securely.

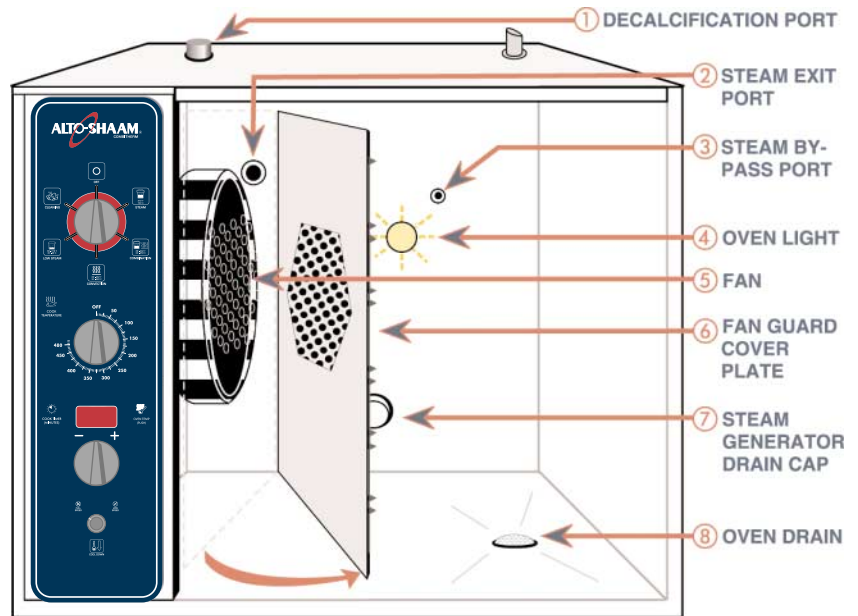

Scalding water will erupt from the Decalcification Port ① when the oven is operating unless the cap is replaced and tightened.

COMBITHERM® DECALCIFICATION



TURN THE SELECTION KNOB TO THE STEAM POSITION.



THE WATER IN THE STEAM GENERATOR WILL BEGIN TO HEAT. ALLOW THE OVEN TO REMAIN IN THIS POSITION FOR A MINIMUM PERIOD OF 10 MINUTES TO DECALCIFY THE STEAM GENERATOR.

DO NOT TURN THE TIMER ON. Severe burns could occur.



CHEF OPERATING TIP

In the case of extreme calcification build-up such as in areas with very hard water, ovens can be left in this condition overnight. Follow the remaining instructions at the start of the next production day. This procedure will help keep the oven operating at peak efficiency.



After a period of 10 minutes or longer —

TURN THE SELECTION KNOB TO THE OFF POSITION.



- 6. USING HAND PROTECTION**, open the oven door and rotate the Steam Generator Drain Cap ⑦ until water begins to flow from the four holes in the cap. In approximately 20 to 60 seconds, a sufficient quantity of water will have drained from the steam generator so that the drain cap can be completely removed. Let the water continue to drain until the flow completely subsides.
- 7.** Loosen the thumb screw(s) and swing Fan Guard Cover Plate ⑥ toward the back of the oven. Using the hand-held hose, direct a stream of water directly into the Steam Exit Port ② several times. Close the swing-out Cover Plate ⑥. Lock the cover into place and tighten thumb screw(s). Close the oven door.



TURN THE SELECTION KNOB TO THE STEAM POSITION.



A new supply of fresh water will begin to fill the steam generator and will flush out all remaining vinegar from the steam generator.

AFTER **JUST 2 MINUTES** OF OPERATION IN THE STEAM MODE, TURN THE SELECTION KNOB TO THE OFF POSITION.



ANY ADDITIONAL LENGTH OF TIME WILL RESULT IN A LOW WATER ERROR OCCURRENCE. OPEN THE OVEN DOOR.

- 8. USING HAND PROTECTION**, replace the Steam Generator Drain Cap by turning it clockwise until there is a slight resistance. At the end of the production day, leave the door slightly ajar.

DO NOT COOK IN ANY PROGRAM MODE WITH VINEGAR IN THE STEAM GENERATOR SYSTEM.



DURING DECALCIFICATION THE WATER FLOWING FROM THE DRAIN CAP IS EXTREMELY HOT! USE HAND PROTECTION WHEN TOUCHING THE STEAM GENERATOR DRAIN CAP. DO NOT TOUCH THE WATER FLOWING OUT OF THE STEAM GENERATOR DRAIN CAP OR STEAM GENERATOR DRAIN.

COMBITHERM® DECALCIFICATION

STANDARD CONTROL
DELUXE CONTROL

STANDARD CONTROL
DELUXE CONTROL

It is **VERY** important to decalcify the oven, particularly in areas with extremely hard water.

PERFORM ONCE A MONTH
in addition to the daily steam generator flush.

WITH THE OVEN AT ROOM TEMPERATURE

1. Begin decalcification with the power switch in the OFF position.
2. Rotate the Steam Generator Drain Cap ⑦ until water begins to flow from the four holes in the cap. In approximately 20 to 60 seconds, a sufficient quantity of water will have drained from the steam generator so that the drain cap can be completely removed.
3. As the water continues to flow from the generator, it will have a milky or cloudy appearance, which indicates deposits in the generator system are beginning to flush out. Let the water continue to drain until the flow completely subsides. Replace the Steam Generator Drain Cap ⑦ by turning it clockwise until there is a slight resistance.
4. Unscrew the cap from the Decalcification Port ①. With the use of a funnel, pour one-half gallon (c. 2 liters) of distilled white vinegar into the Decalcification Port.
5. Replace the cap on the Decalcification Port ① and tighten securely.

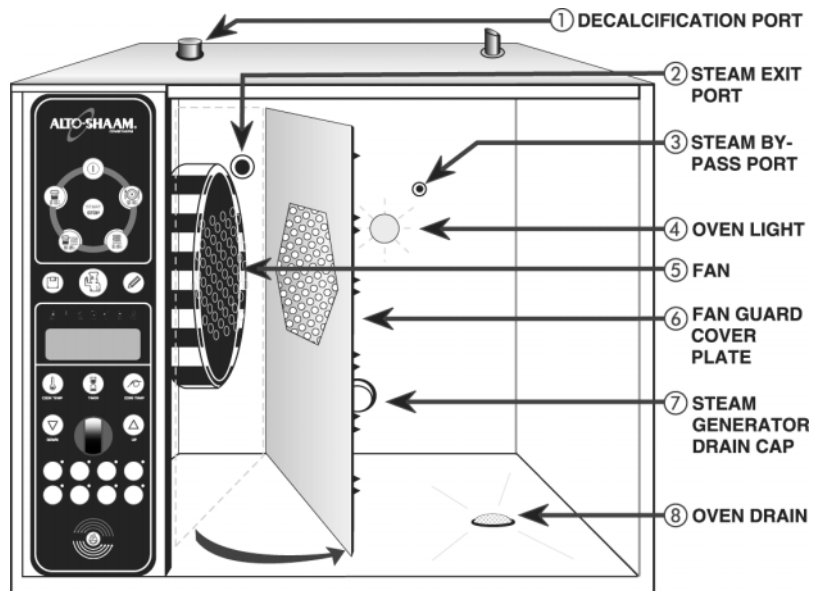

Scalding water will erupt from the Decalcification Port ① when the oven is operating unless the cap is replaced and tightened.

COMBITHERM® DECALCIFICATION

**STANDARD CONTROL
DELUXE CONTROL**

① PRESS THE ON/OFF POWER KEY TO THE ON POSITION.

THE WATER IN THE STEAM GENERATOR WILL BEGIN TO HEAT. ALLOW THE OVEN TO REMAIN IN THIS POSITION FOR A MINIMUM PERIOD OF 10 MINUTES TO DECALCIFY THE STEAM GENERATOR.

In the case of extreme calcification build-up such as in areas with very hard water, ovens can be left in this condition overnight. Follow the remaining instructions at the start of the next production day. This procedure will help keep the oven operating at peak efficiency.

After a period of 10 minutes or longer —

① PRESS THE ON/OFF POWER KEY TO THE OFF POSITION.

6. **USING HAND PROTECTION**, rotate the Steam Generator Drain Cap ⑦ until water begins to flow from the four holes in the cap. In approximately 20 to 60 seconds, a sufficient quantity of water will have drained from the steam generator so that the drain cap can be completely removed. Let the water continue to drain until the flow completely subsides.

7. Open the oven door. Loosen the thumb screw(s) and swing Fan Guard Cover Plate ⑥ toward the back of the oven. Using the hand-held hose, direct a stream of water directly into the Steam Exit Port ② several times. Close the swing-out Cover Plate ⑥. Lock the cover into place and tighten thumb screw(s). Close the oven door.

① PRESS THE ON/OFF POWER KEY TO THE ON POSITION.

 PRESS THE STEAM MODE KEY.

A new supply of fresh water will begin to fill the steam generator and will flush out all remaining vinegar from the steam generator.

 AFTER **JUST 2 MINUTES** OF OPERATION IN THE STEAM MODE, PRESS THE START/STOP KEY. ANY ADDITIONAL LENGTH OF TIME WILL RESULT IN A LOW WATER ERROR OCCURRENCE.

① PRESS THE ON/OFF POWER KEY TO THE OFF POSITION AND OPEN THE OVEN DOOR.

8. **USING HAND PROTECTION**, replace the Steam Generator Drain Cap by turning it clockwise until there is a slight resistance. At the end of the production day, leave the door slightly ajar.

**DO NOT COOK IN ANY PROGRAM MODE
WITH VINEGAR IN THE STEAM GENERATOR SYSTEM.**



DURING DECALCIFICATION THE WATER FLOWING FROM THE DRAIN CAP IS EXTREMELY HOT! USE HAND PROTECTION WHEN TOUCHING THE STEAM GENERATOR DRAIN CAP. DO NOT TOUCH THE WATER FLOWING OUT OF THE STEAM GENERATOR DRAIN CAP OR STEAM GENERATOR DRAIN.

COMBITHERM® CLEANING & MAINTENANCE

DAILY GASKET CLEANING

It is important to prolong the life of the oven gasket by cleaning this item on a daily basis. Routine cleaning will help protect the composition of the gasket from deterioration caused by acidic foods. After allowing the oven to cool, remove pull-out gasket and wash in hot, soapy water. *Do not* place in the dishwasher.



Always replace the gasket before cleaning the oven interior or operating the oven.



EMERGENCY OPERATION

In the event of an error code, operation of the Combitherm can be continued on a limited basis for a short duration. Cooking times may be longer than normal operation and close monitoring of the cooking process is recommended. Contact an authorized service agency immediately if the problem cannot be rectified with simple steps in the troubleshooting guidelines located in this manual. Error conditions under which continued operation can be conducted are indicated by YES in the chart shown below.

When the oven malfunctions, an error code will appear in the display.

 PRESS THE START/STOP KEY TO ACKNOWLEDGE THE ERROR.
The keys for the usable operational modes will begin to flash and can be operated normally.

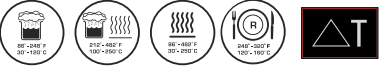
 SELECT AND PRESS ONE OF THE COOKING MODES INDICATED.
The oven control will only respond to the oven mode keys flashing.

SET THE OVEN CONTROLS AS IF OPERATING UNDER NORMAL CIRCUMSTANCES.

Depending on the error code involved, oven function, such as temperature range, may be limited.

 PRESS THE START/STOP KEY TO BEGIN THE COOKING PROCESS.

 PRESS THE START/STOP KEY WHEN THE TIMER EXPIRES.

WHEN THE OVEN FAULT IS CORRECTED, THE COMBITHERM WILL RETURN TO NORMAL OPERATION.

ERROR CODE	DISPLAY MESSAGE	GAS	ELECTRIC	STEAM ¹ MODE	SUPERHEATED STEAM MODE	CONVECTION MODE	RETERM MODE	DELTA-T MODE
E01	Low water level	YES	YES	NO	NO	up to 356°F (180°C)	NO	YES
E02	EL-temperature too high CONTROL COMPARTMENT TEMP	YES	YES	YES	Up to 284°F (140°C)	Up to 284°F (140°C)	Up to 284°F (140°C)	Up to 284°F (140°C)
E03	Fan Fault BLOWER FAN	NO	YES	Up to 212°F (100°C)	NO	NO	NO	NO
E04	EL-fan fault CONTROL COOLING FAN	NO	YES	YES	Up to 284°F (140°C)	Up to 284°F (140°C)	Up to 284°F (140°C)	Up to 284°F (140°C)
E05	Gas fault	YES	NO	YES	YES	YES	YES	YES
E15	Condenser oven temperature HIGH CONDENSATE TANK TEMP	YES	YES	NO	NO	Up to 356°F (180°C)	NO	YES
E21	Oven probe error TEMPERATURE PROBE	NO	YES	212°F only (100°C)	NO	NO	NO	NO
E22	CTC error TEMPERATURE PROBE	YES	YES	YES	YES	YES	YES	YES
E23	SG-probe error STEAM GENERATOR PROBE B4	YES	YES	YES	YES	YES	YES	YES
E24	Bypass probe error	NO	YES	Up to 210°F (99°C)	NO	YES	NO	YES
E25	Condenser probe error B3 PROBE	NO	YES	YES ²	Up to 356°F ² (180°C)	Up to 356°F ² (180°C)	Up to 356°F ² (180°C)	YES ²
E26	SG probe error STEAM GENERATOR PROBE	NO	YES	YES	YES	YES	YES	YES
E23 & E26	SG probe error ³ STEAM GENERATOR PROBE B4	NO	YES	YES ³	YES ³	YES ³	NO	YES ³
E33	SG heat error STEAM GENERATOR ELEMENT	NO	YES	YES	YES	YES	YES	YES
E34	Steam Generator pump error	NO	YES	YES	YES	YES	YES	YES
E81	Program memory error	YES	YES	YES	YES	YES	YES	YES
E83	Algorithm error	YES	YES	YES	YES	YES	YES	YES
E89	12C error	YES	YES	YES	YES	YES	YES	YES

¹ Cooking time increases significantly. Food on the upper shelves is finished first.

² Water injection into the condenser is activated for the entire cooking mode (high water consumption).

³ When error codes E23 and E26 appear simultaneously, steam generator does not preheat.

CONTROL RESET

There is a remote possibility in the day-to-day operation of the Combitherm that the control could lock or freeze. If this occurs, the control is easy to reset.



PRESS AND HOLD the Power Key for a period of 5 seconds.

Release the Power Key.

The control will reset itself within approximately 15 seconds.

WHEN RESET, THE DISPLAY WILL INDICATE THE TIME AND DATE AND THE CONTROLS WILL BE FULLY FUNCTIONAL.

TROUBLESHOOTING

In the event of a Combitherm malfunction during operation, an error code and message will appear in the display to assist in finding a rapid solution to the problem. The following is a list of all error codes including the possible cause along with a solution.

CODE	DESCRIPTION OF ERROR	POSSIBLE CAUSE/REMEDY
E01	Low water level: Sufficient water level in steam generator has not been reached with 3 minutes.	Water tap is closed. Water pressure is low. Filter in solenoid valve or water connection is clogged. Water level probe is calcified or defective. Solenoid valve Y1 is defective. Pressure loop is calcified. Steam generator drain cap is not water tight. Connection to X7 connector is broken.
E01	Low water level: Water pressure is under 11 PSI (0.7 bar) after the solenoid valve is opened for 5 seconds.	Water tap is closed. Filter in solenoid valve or water connection is clogged. Solenoid valve Y1 is defective.
E02	Excessive temperature in service area: An additional fan will engage at a temperature of 113°F (45°C) and the error message will occur at a service area temperature of 176°F (80°C).	Auxiliary 12 V fan does not turn on due to defective thermostat or contactor. Ventilation vents are blocked due to inefficient distance from wall at installation site. Minimum distance to equipment such as fryers, grills, kettles, etc. has not been maintained.
E03	Fan motor shuts down from a tripped internal PTC.	A phase from the main power supply is missing. The fan motor is defective. Power phase reversed causing fan to run in reverse. F10 fuse is tripped.
E03	Motor shuts down fan.	Trip circuit has been set too low. Direction of motor rotation is wrong. A phase is missing from the main power supply. The motor protection switch is defective. Power phase reversed causing fan to run in reverse. Fan wheel is obstructed. The fan motor is defective.
E04	Auxiliary 120 fan motor not running.	Auxiliary fan is defective or obstructed. Defective wiring or loose connection to auxiliary fan.
E11	Oven probe (N6 thermocouple) measures a temperature in excess of 572°F (300°C).	Convection contactors are burned and no longer disengage. Motor not operating due to two defective F10 fuses. Defective oven temperature probe N6.
E13	Steam generator probe (B4 thermocouple) measures a temperature in excess of 248°F (120°C).	Calcification in steam generator. Water level probe is grounded causing immersion elements to energize. Water softener causing bubbles in the steam generator.

TROUBLESHOOTING

CODE	DESCRIPTION OF ERROR	POSSIBLE CAUSE/REMEDY
E15	Condenser probe (B3 thermocouple) measures a temperature in excess of 212°F (100°C).	Water tap is closed. Oven is connected to warm water supply. Inlet filter on solenoid valve is dirty. Condenser cooling solenoid valve or solenoid valve coil (Y2) is defective.
E21	Oven temperature probe (N6) is interrupted.	Probe connection is loose or defective at X6
E22	Core temperature probe (B10) is interrupted.	Probe connection is loose or defective at X6
E23	Steam generator probe (B4 thermocouple) is interrupted.	Probe connection is loose at X6 on the control module. Steam generator probe (B4) is defective. Bad probe connection.
E24	Stem Bypass probe (B5) is interrupted.	Probe connection is loose or defective at X6
E25	Condensate probe (B3 thermocouple) is interrupted.	Probe connection is loose or interrupted at X6 Probe is defective.
E26	Safety temperature probe (N8 thermocouple) is interrupted.	Probe connection is loose at X6 on the control module. STB steam generator probe (N8) is interrupted or defective. Immersion element safety thermostat (N8) is tripped.
E27	STB (N8 thermocouple) measures a temperature in excess of 266°F (130°C).	Calcification on steam elements Water level probe is grounded causing immersion elements to energize. Water softener causing bubbles in the steam generator.
E29	Thermocouple shorted to ground.	Check all thermocouple probes to ground.
E33	Steam generator probe (B3) fails to measure increase in temperature to 41°F (5°C) within a 3 minute period of time.	Immersion element safety thermostat N8 tripped. Immersion element contactors K1, K2, K3 defective. B4 probe calcified.
E34	Steam generator pump malfunction.	Pump (M4) defective. Drain valve blocked or drain clogged. Ground short on water level probe due to calcification. Fill opening in water settling area of level probe is calcified.
E80	ID (identity) error.	The electronic control cannot differentiate between gas or electric operation and disconnects all circuit connections. Contact problem on X3 connection.
E81	Cooking procedure-programming error.	Unit has been changed from Fahrenheit to Celsius.
E82	Preset program or cleaning program has become corrupt.	The sequence must be deleted and reprogrammed.
E83	Communication problem between display and relay board.	Press and hold the Chef function key while in the OFF mode and verify both the BM and SM software versions.
E96	Incompatibility between software and hardware.	Communications cable is loose between relay board and display board. Communications cable defective.



Alto-Shaam has established a twenty-four hour emergency service call center to offer immediate customer access to a local authorized service agency outside of standard business hours. The emergency service access is provided exclusively for Alto-Shaam equipment and is available throughout the United States through the use of Alto-Shaam's toll-free number. Emergency service access is available seven days a week including holidays.

SERVICE VIEW • OVEN EXTERIOR

MODEL 10•10 MARINE - RIGHT-HAND RECESSED DOOR

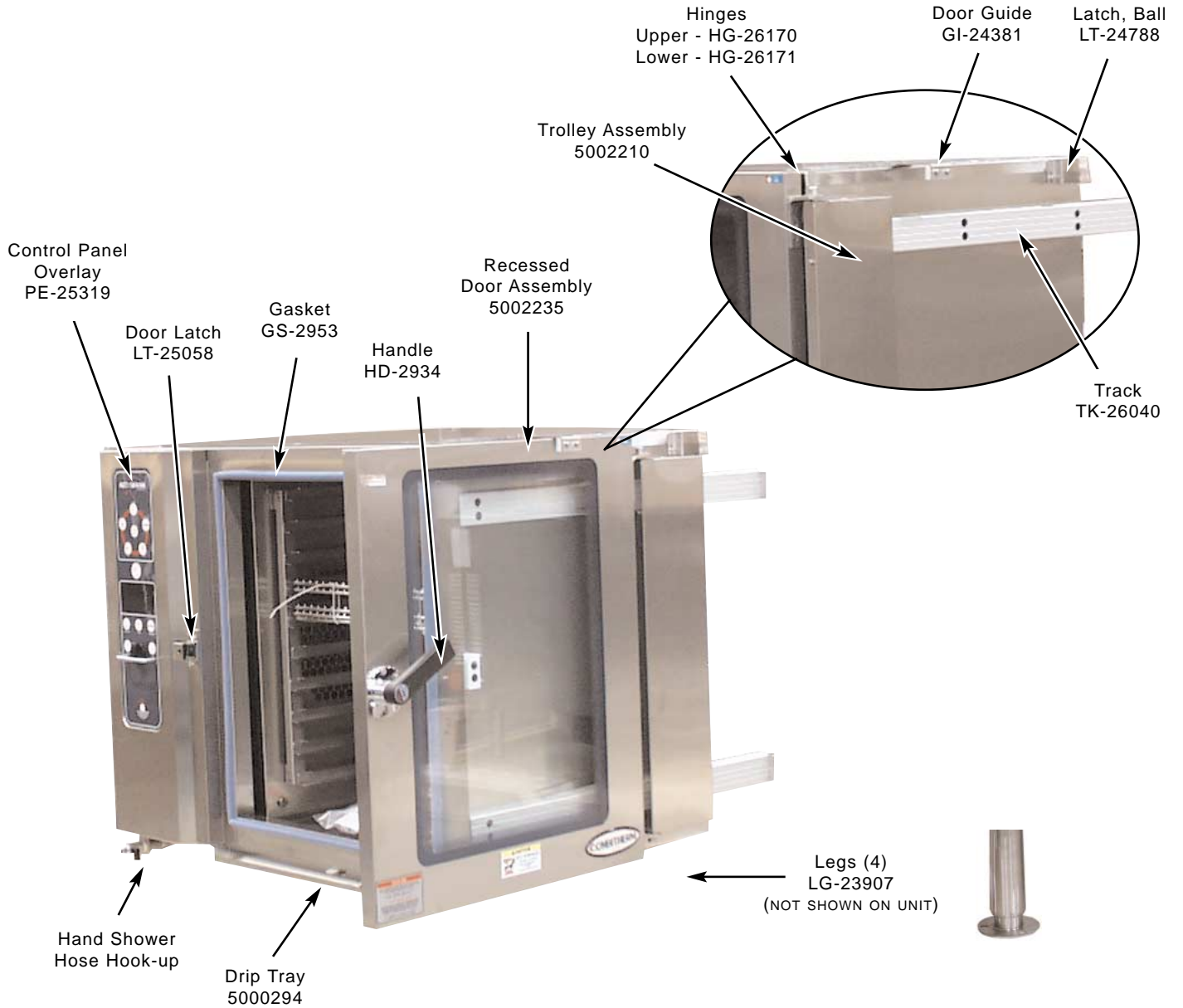

SERVICE VIEW • OVEN INTERIOR

REPRESENTING MODEL: 10•10 MARINE

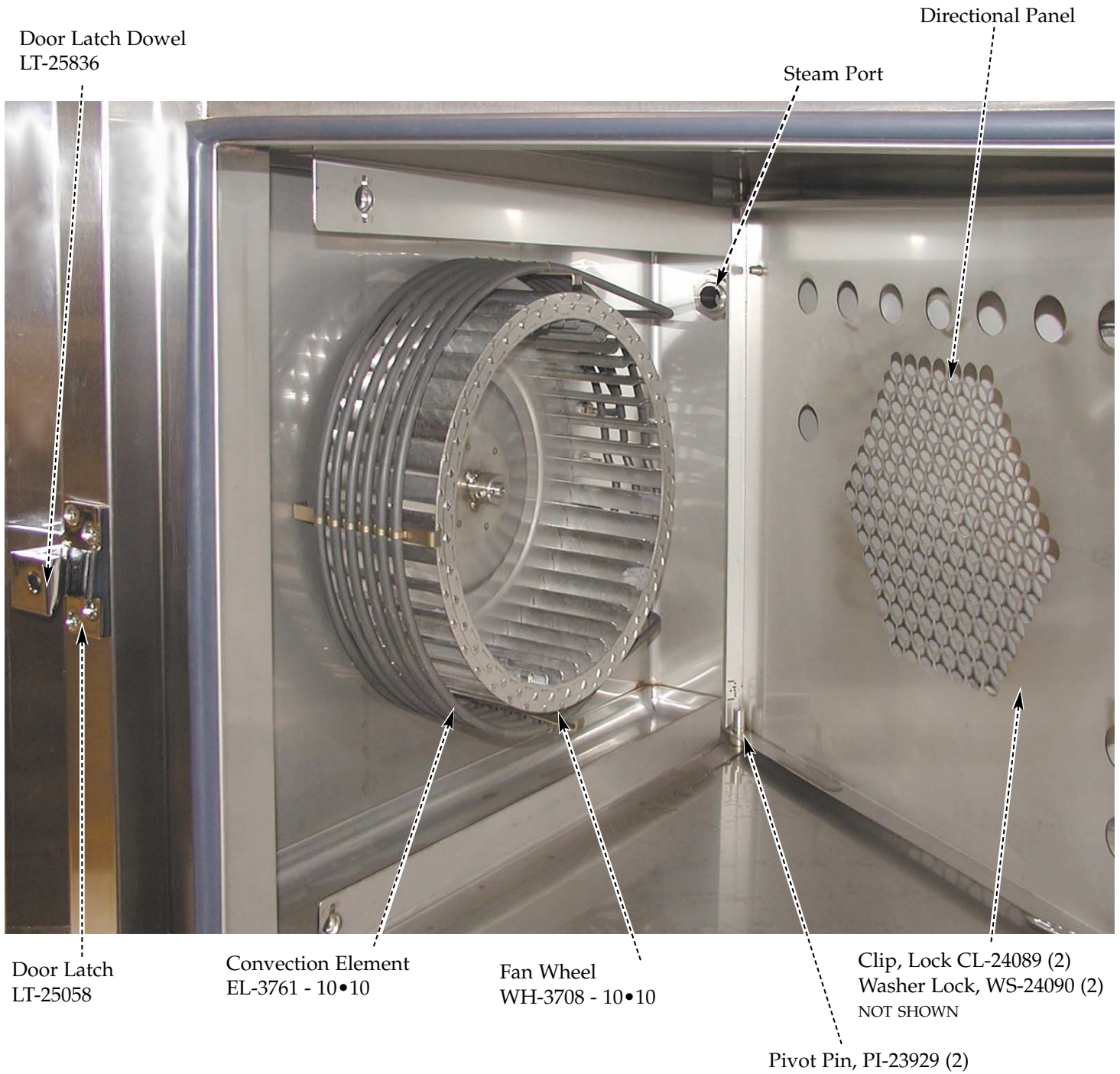

SERVICE VIEW • SIDE PANEL ACCESS

GENERALLY REPRESENTING MODEL: 10•10 MARINE

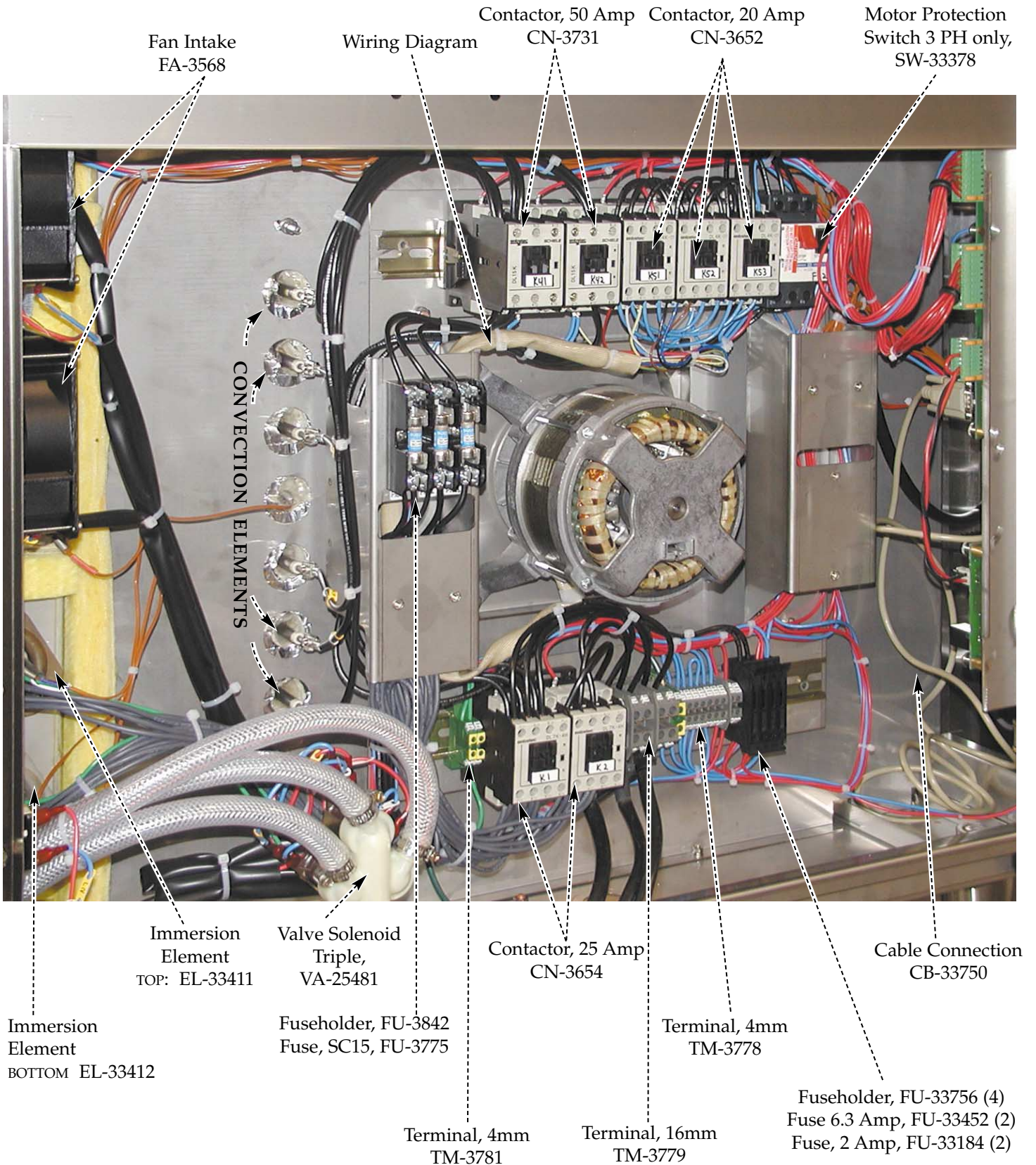

Fan Intake
FA-3568

Wiring Diagram

Contactor, 50 Amp
CN-3731

Contactor, 20 Amp
CN-3652

Motor Protection
Switch 3 PH only,
SW-33378

CONNECTION ELEMENTS

Immersion
Element
TOP: EL-33411

Valve Solenoid
Triple,
VA-25481

Contactor, 25 Amp
CN-3654

Cable Connection
CB-33750

Immersion
Element
BOTTOM EL-33412

Fuseholder, FU-3842
Fuse, SC15, FU-3775

Terminal, 4mm
TM-3778

Terminal, 4mm
TM-3781

Terminal, 16mm
TM-3779

Fuseholder, FU-33756 (4)
Fuse 6.3 Amp, FU-33452 (2)
Fuse, 2 Amp, FU-33184 (2)

Parts List • Combitherm ML Electric

PART DESCRIPTION	10•10					
DOOR AND EXTERIOR PARTS:						
DOOR, ARM (MARINE MODELS ONLY)	CT-22887					
DOOR, ARM PLATE (MARINE MODELS ONLY)	CT-22885					
DOOR BUSHING, ARM (MARINE MODELS ONLY)	CT-22886					
DOOR, CLIP	LT-25080					
DOOR DRAIN, OUTER	DA-25073					
DOOR, HANDLE INSERT	HD-23084					
DOOR HANDLE, RIGHT HAND	HD-2934					
DOOR LATCH, INNER GUARD PLATE	LT-25394					
DOOR LATCH, RIGHT HAND	LT-25058					
DOOR LATCH INSET, RIGHT HAND	LT-25836					
DOOR, LATCH MAGNET SWITCH	LT-3738					
DOOR LATCH MOUNTING HARDWARE	SC-22768					
DOOR, INNER BUMPER	BM-25072					
DOOR, INNER BUMPER STOP	BM-25089					
DOOR ASSEMBLY	5000470					
DRIP TRAY	5000294					
GASKET, DOOR	GS-2953					
HINGE, INNER DOOR HINGE	HG-25111					
HINGE, INNER DOOR TOP CORNER	HG-25390					
HINGE, INNER DOOR BUTTON CORNER	HG-25391					
HINGE, LOWER PLATE	HG-25100					
HINGE, LOWER DOOR RATCHET	HG-25101					
HINGE, UPPER PLATE	HG-25099					
HINGE, UPPER DOOR RATCHET	HG-25079					
HINGE, UPPER PLATE MOUNTING HARDWARE:						
— SCREW, AXIS	SC-25102					
— WASHER, COVERING	WS-25127					
— WASHER, ECCENTRIC BLOCK	WS-25124					
— WASHER, SCHMORR STYLE	WS-25478					
— HINGE, TOP STOP	HG-25077					
PANEL, CONTROL OVERLAY (STANDARD MODELS)	PE-25319					
PANEL, CONTROL OVERLAY (DELUXE MODELS)	PE-25048					
PANEL LOCK-DOWN SCREW	CL-24089					
LOCK CLIP	WS-24090					
PROGRAM QUICK KEYS PICTURE GRAPHICS (DELUXE MODELS ONLY)	PE-25345					

Parts List • Combitherm ML Electric

PART DESCRIPTION	10•10					
ELECTRICAL AND ELECTRONIC PARTS:						
BOARD, DISPLAY CONTROL	BA-33732					
— ADJUSTING ROCKER (COMPLETE)	KN-33734					
— ADJUSTING ROCKER KNOB	KN-33735					
— BUSHING, DISTANCE	BU-25094					
— NUT, KNURLED M3	NU-25095					
BOARD, RELAY CONTROL	BA-33736					
BOARD, POWER SUPPLY	BA-33554					
BOARD, LED CLOSED SYSTEM	BA-33733					
BOARD, PROGRAM MODULE (DELUXE MODELS)	BA-33742					
— CONNECTOR, X11/X12 (DELUXE MODELS ONLY)	CR-33743					
BOARD, COMMUNICATION 5000KM (OPTION)	BA-33738					
CONTACTORS, 20A, TYPE # DL4K-01	CN-3652					
CONTACTORS, 25A, TYPE # DL7K-4H	CN-3654					
CONTACTORS, 50A, TYPE # DL15K-00	CN-3731					
ELEMENT, HEATING, FLANGED IMMERSION 6 kW	EL-33412					
ELEMENT, HEATING, FLANGED IMMERSION 9 kW	EL-33411					
ELEMENT, HEATING, CONVECTION (208-240v, 1PH)	EL-3761					
(208-240v, 3PH)	—					
(440-480v, 3PH)	EL-3761					
ELEMENT, HEATING, CONVECTION MNTG HARDWARE						
— WASHERS, FLAT	WS-22294					
— WASHERS, SPLIT LOCK	WS-22300					
— HEX NUTS	NU-22286					
— O-RING	SA-23932					
— WASHER, CONICAL	13607					
FAN, INTAKE, AUXILIARY DC4112NX	FA-3568					
FUSE, SLOW-BLO 2AMP, 250V	FU-33184					
FUSE, SC-5 (440-480v, 3PH ONLY)	FU-33581					
FUSE, NEOZED 6.3AMP	FU-33452					
FUSE HOLDER, 6.3AMP (380-415v, 3PH ONLY)	—					
FUSE, 15AMP CLASS G (208-240v, 1PH ONLY)	FU-3775					
FUSE HOLDER, 15AMP CLASS G (208-240v, 3PH)	FU-3772					
FUSE HOLDER, 15AMP, 3POL, CLASS G (208-240v, 3PH)	FU-3842					
FUSE, 45AMP, MP, CLASS G	FU-33040					
FUSE HOLDER, DIN RAIL MOUNT WITH DISCONNECT	FU-33756					
FUSE HOLDER, 60AMP, 3POL, CLASS G	FU-33039					

Parts List • Combitherm ML Electric

PART DESCRIPTION	10•10					
ELECTRICAL AND ELECTRONIC PARTS CONTD:						
MOTOR CAPACITOR, 12MFD (208-240v, 1PH ONLY)	PA-33499					
MOTOR CAPACITOR, 25MFD (208-240v, 1PH ONLY)	FA-33465					
MOTOR, SUB ASSEMBLY (208-240v, 1PH ONLY)	MO-33466					
MOTOR, SUB ASSEMBLY (208-240v, 1PH/3 PH)	5000276					
MOTOR, SUB ASSEMBLY (440-480v, 3 PH)	—					
— FAN, WHEEL	WH-3708					
MOTOR, SUB ASSEMBLY (380-415V NPE & 440-480v 3PH)	5000602					
PROBE, CONDENSATE	PR-33751					
PROBE, OVEN TEMPERATURE	PR-33724					
PROBE, PRODUCT (MULTI-POINT CTC)	PR-33746					
PROBE, PROTECTION (STEAM)	PR-33759					
PROBE, STEAM STANDBY	PR-33724					
PROBE, STEAM BYPASS	PR-33751					
— PROBE SEAL	SA-22322					
— PROBE SEAL, THERMOCOUPLE	SA-25061					
PROBE, WATER LEVEL	PR-3706					
PROBE, WATER LEVEL TIP CONNECTORS	CR-3851					
SWITCH, MOTOR PROTECTION (208-240v, 1PH ONLY)	SW-33500					
SWITCH, MOTOR PROTECTION (3PH ONLY)	SW-33378					
TERMINAL, GROUND	TM-3781					
TERMINAL, GROUND X10 (440V, 3 PH)	TM-3932 TM-3782					
TERMINAL PARTITION (440V, 3 PH)	TM-3783 TM-3785 TM-3786					
TERMINAL, PLUG	TM-3926					
TERMINAL BLOCK X1	TM-33747					
TERMINAL BLOCK X2	TM-33748					
TERMINAL BLOCK X3	TM-33749					
TERMINAL BLOCK X6 (CONNECTOR, 16 POLE)	TM-33773					
TERMINAL BLOCK X7 (CONNECTOR, 9 POLE)	TM-33774					
TERMINAL BLOCK X10	TM-3779					
TERMINAL BLOCK X10 & X11	TM-3778					

Parts List • Combitherm ML Electric

PART DESCRIPTION	10•10					
ELECTRICAL AND ELECTRONIC PARTS CONTD:						
— TERMINAL JUMPER BAR (2 POLE)	TM-33674					
— TERMINAL JUMPER BAR (3 POLE)	TM-33106					
— TERMINAL JUMPER BAR (2 POLE)	TM-33675					
— TERMINAL JUMPER BAR (3 POLE)	—					
— TERMINAL JUMPER BAR (4 POLE)	TM-3787					
THERMOSTAT, SAFETY (440-480V, 3PH ONLY)	TT-3750 TT-3750					
TRANSFORMER (440-480V, 3PH ONLY)	TN-33344					
VALVE, TRIPLE SOLENOID	VA-25481					
MECHANICAL PARTS:						
BUSHING, MOTOR ASSEMBLY	BU-23894					
BUSHING, SOCKET MEMBRANE, VENT	BU-22204					
DRAIN SCREEN	DA-2943					
HOSE, CLEAR FLEX	HO-22255					
LAMP, BULB	LP-3686					
LAMP, GLASS COVER	LP-33413					
LAMP SEAL	SA-23934					
LAMP, SOCKET RECEPTACLE	RP-3986					
LEGS, 2" (51mm) ADJUSTABLE	LG-23907					
PEDESTAL STAND, ADJUSTABLE (MARINE MODELS ONLY)	CT-2607779					
PEDESTAL STAND, ADJUSTABLE — WITH SCREWED FLANGE PLATE (MARINE MODELS ONLY)	—					
PROBE PLUG ADAPTOR	PG-3826					
PROBE PLUG	PG-3827					
PROBE PLUG SEAL	SA-22199					
PROBE SEAL, INSERT	SA-22322					
PROBE SEAL, CONE	SA-22321					
PROBE SEAL, TOP	SA-22320					
SCREW COVER, M6 NATURAL	SC-23936					
STEAM GENERATOR OUTLET CAP	CP-22758					
STEAM GENERATOR OUTLET CAP WASHER, SILICONE	WS-22751					
TROLLEY BRIDGE, LOWER FRONT	—					
TROLLEY GASKET, BOTTOM	—					

Parts List • Combitherm ML Electric

PART DESCRIPTION	10•10					
PLUMBING PARTS:						
CONDENSATE TANK COVER NUT	SC-24070					
CONDENSATE TANK COVER SCREW	SC-23936					
CONDENSER, INJECTION NOZZLE	5000284					
CONDENSER, O-RING	SA-22212					
CONDENSER, O-RING 8x2.5 EPDM	SA-23109					
PIPE, DRAIN EXTENSION	PP-25137					
HAND SHOWER ASSEMBLY:						
— HAND SHOWER (FULL ASSEMBLY)	14442					
— HOSE, BALL VALVE	VA-22684					
— HOSE, SPRAY HANDLE	PB-23920					
— HOSE ASSEMBLY	PB-23922					
— HOSE, SPRAY NOZZLE	PB-23919					
— HOSE WASHERS, FLAT SEAL - 3/4" (19mm)	WS-22207					
HOSE, CONNECTOR ELBOW WITH SEAL	HO-22116					
HOSE, CONNECTOR ELBOW SEAL	WS-22208					
HOSE, PUMP	HO-25070					
HOSE, RADIATOR	HO-22254					
HOSE, STEAM BYPASS	HO-2957					
PROBE, MEASURE WELD	5000283					
PUMP, STEAM GENERATOR DRAIN	DA-24973					
— PUMP, MOUNTING HARDWARE	1000719					
STEAM GENERATOR DRAIN ELBOW	EB-25106					
STEAM GENERATOR INJECTION NOZZLE	5000292					
SCREEN FILTER	FI-2946					
BACK FLOW PREVENTOR	VA-24587					
FILTER ASSEMBLY	FI-23014					
FILTER, SPARE	FI-23017					

Parts List • Combitherm ML Electric

PART DESCRIPTION	10•10					
S-Control Parts:						
Oven Temperature Probe	PR-33724					
S-Control Relay Board	BA-34031					
Power Supply Board	BA-33554					
Communication Cable	CB-34033					
Program Board	BA-34030					
Temperature Board	BA-34029					
Timer/Speed Board	BA-34028					
Program/Temperature Knob	KN-34037					
Timer Knob	KN-34036					
Speed Knob	KN-34035					

TRANSPORTATION DAMAGE and CLAIMS



All Alto-Shaam equipment is sold F.O.B. shipping point, and when accepted by the carrier, such shipments become the property of the consignee.

Should damage occur in shipment, it is a matter between the carrier and the consignee. In such cases, the carrier is assumed to be responsible for the safe delivery of the merchandise, unless negligence can be established on the part of the shipper.

1. Make an immediate inspection while the equipment is still in the truck or immediately after it is moved to the receiving area. Do not wait until after the material is moved to a storage area.
2. Do not sign a delivery receipt or a freight bill until you have made a proper count and inspection of all merchandise received.
3. Note all damage to packages directly on the carrier's delivery receipt.
4. Make certain the driver signs this receipt. If he refuses to sign, make a notation of this refusal on the receipt.
5. If the driver refuses to allow inspection, write the following on the delivery receipt:
Driver refuses to allow inspection of containers for visible damage.
6. Telephone the carrier's office immediately upon finding damage, and request an inspection. Mail a written confirmation of the time, date, and the person called.
7. Save any packages and packing material for further inspection by the carrier.
8. Promptly file a written claim with the carrier and attach copies of all supporting paperwork.

We will continue our policy of assisting our customers in collecting claims which have been properly filed and actively pursued. We cannot, however, file any damage claims for you, assume the responsibility of any claims, or accept deductions in payment for such claims.

ALTO SHAAM. LIMITED WARRANTY

Alto-Shaam, Inc. warrants to the original purchaser that any original part that is found to be defective in material or workmanship will, at Alto-Shaam's option, subject to provisions hereinafter stated, be replaced with a new or rebuilt part.

The labor warranty remains in effect one (1) year from installation or fifteen (15) months from the shipping date, whichever occurs first. Alto-Shaam will bear normal labor charges performed during standard business hours, and excluding overtime, holiday rates or any additional fees.

The parts warranty remains in effect for one (1) year from installation or fifteen (15) months from the shipping date, whichever occurs first.

However, the heating element on Halo Heat[®] cook/hold ovens and the refrigeration compressor on Alto-Shaam Quickchillers[™] are warranted for a period of five (5) years from installation. The labor warranty is the same as stated above; namely, for one (1) year from installation or fifteen (15) months from the shipping date, whichever occurs first.

THIS WARRANTY DOES NOT APPLY TO:

1. Calibration.
2. Replacement of light bulbs and/or the replacement of display case glass due to damage of any kind.
3. Equipment damage caused by accident, shipping, improper installation or alteration.
4. Equipment used under conditions of abuse, misuse, carelessness or abnormal conditions including, but not limited to, equipment subjected to harsh or inappropriate chemicals including, but not limited to, compounds containing chloride or quaternary salts, poor water quality, or equipment with missing or altered serial numbers.
5. Damage incurred as a direct result of poor water quality, inadequate maintenance of steam generators and/or surfaces affected by water quality. Water quality and required maintenance of steam generating equipment is the responsibility of the owner/operator.
6. Damage caused by use of any cleaning agent other than Alto-Shaam's Combitherm[®] Cleaner including, but not limited to, damage due to chlorine or other harmful chemicals. Use of Alto-Shaam's Combitherm[®] Cleaner on Combitherm[®] ovens is highly recommended.
7. Any losses or damage resulting from malfunction, including loss of product or consequential or incidental damages of any kind.
8. Equipment modified in any manner from original model, substitution of parts other than factory authorized parts, removal of any parts including legs, or addition of any parts.

This warranty is exclusive and is in lieu of all other warranties, expressed or implied, including the implied warranties of merchantability and fitness for a particular purpose. In no event shall Alto-Shaam be liable for loss of use, loss of revenue or profit, or loss of product, or for any indirect or consequential damages. No person except an officer of Alto-Shaam, Inc. is authorized to modify this warranty or to incur on behalf of Alto-Shaam any other obligation or liability in connection with Alto-Shaam equipment.

ALTO-SHAAM, INC.

RECORD THE MODEL AND SERIAL NUMBER OF THE APPLIANCE FOR EASY REFERENCE.
ALWAYS REFER TO BOTH MODEL AND SERIAL NUMBER IN ANY CONTACT WITH ALTO-SHAAM REGARDING THIS APPLIANCE.

Model: _____ Date Installed: _____
Voltage: _____ Purchased From: _____
Serial Number: _____

W164 N9221 Water Street • P.O. Box 450 • Menomonee Falls, Wisconsin 53052-0450 • U.S.A.

PHONE: 262.251.3800 • 800.558-8744 USA/CANADA

FAX: 262.251.7067 • 800.329.8744 U.S.A. ONLY

WEBSITE: www.alto-shaam.com

PRINTED IN U.S.A.