

LAVABICCHIERI PROGRAM 25 CF-CR

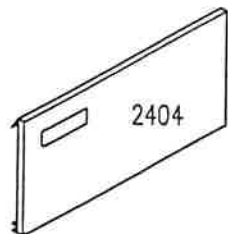

TAVOLA
PR

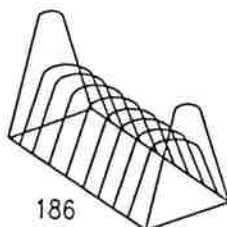

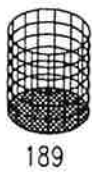
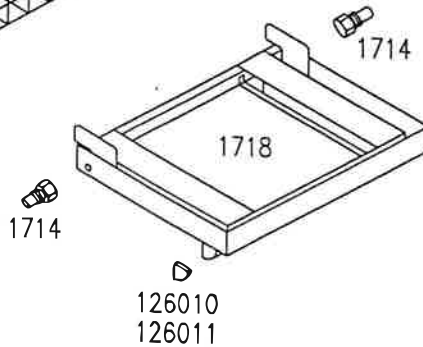
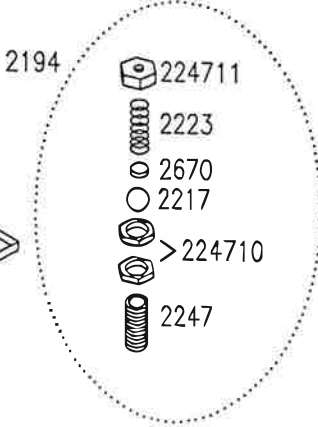
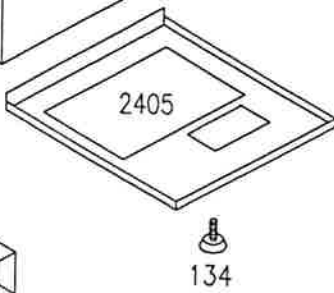
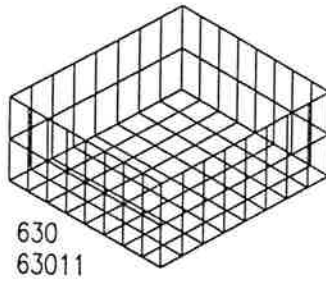
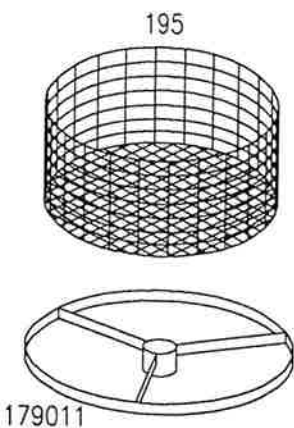
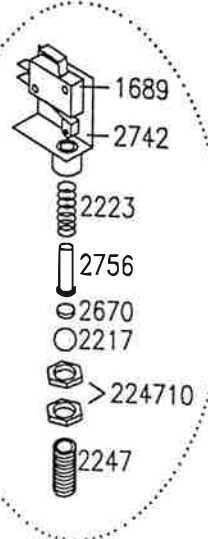
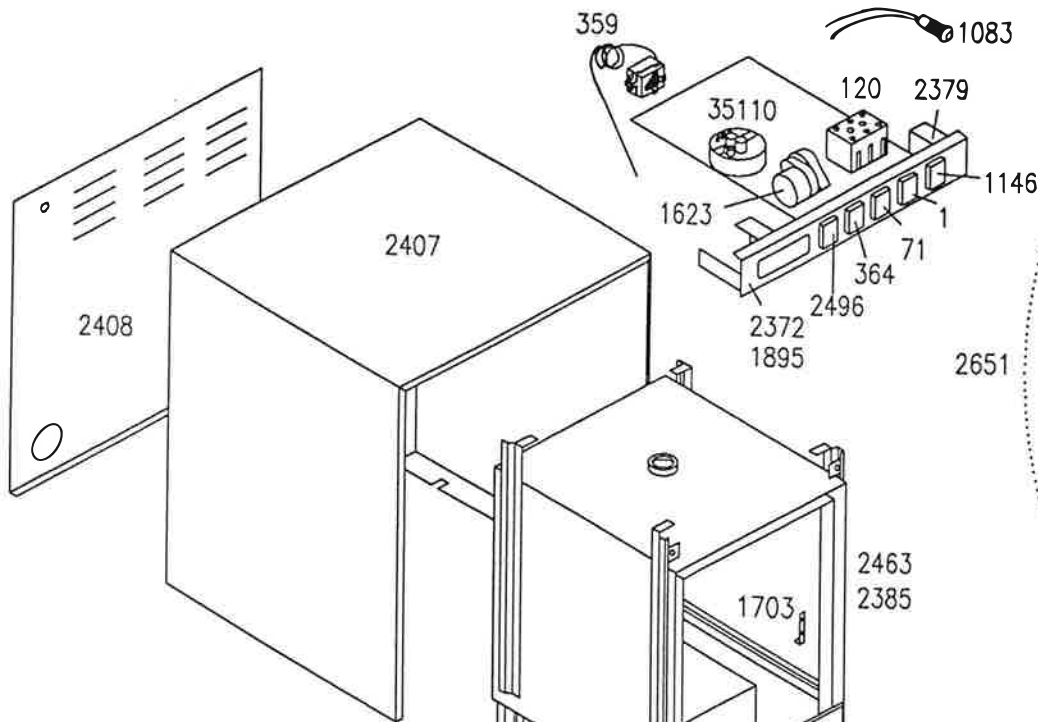
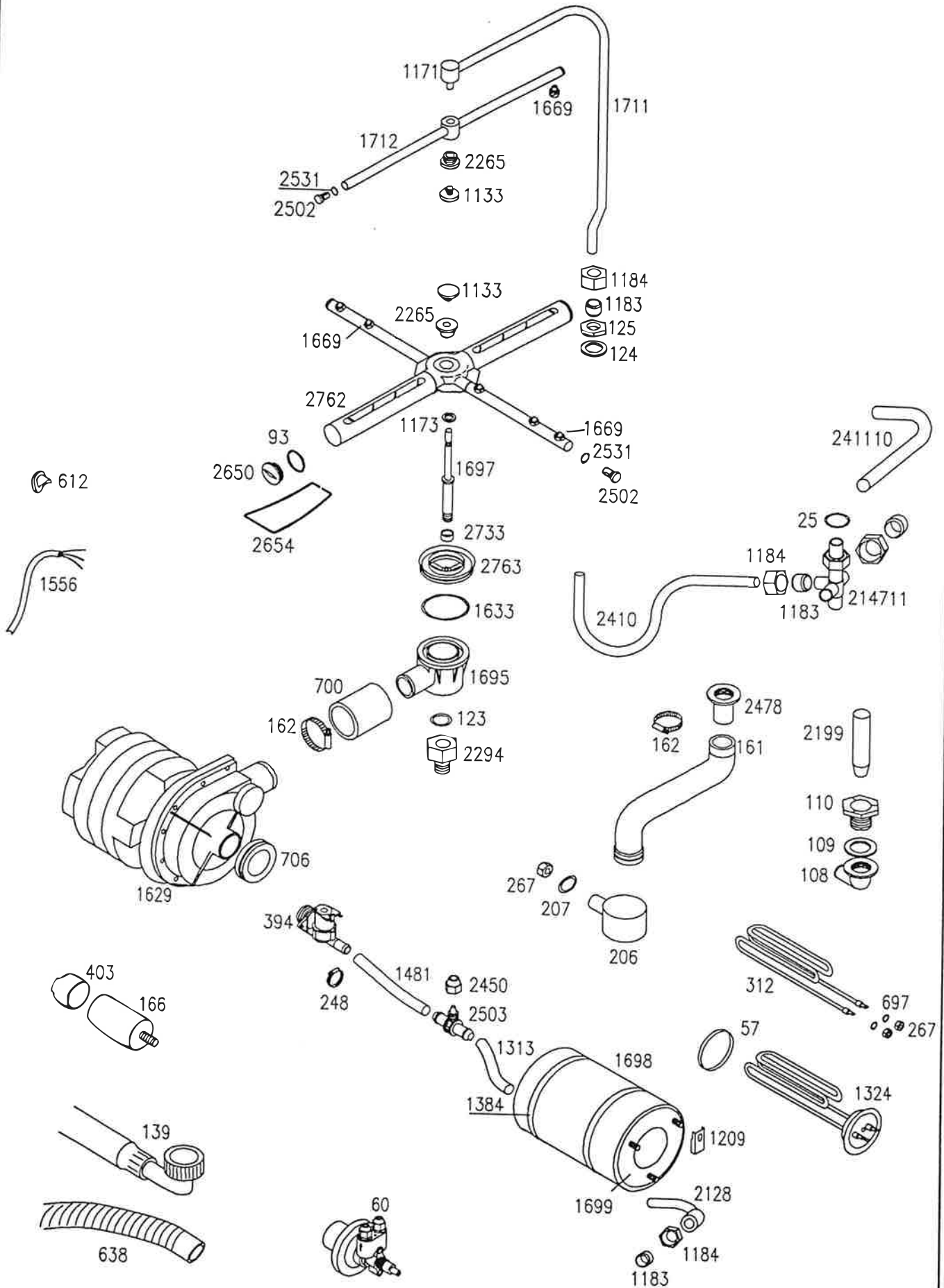

CESTI PER LAVABICCHIERI E LAVAPIATTI

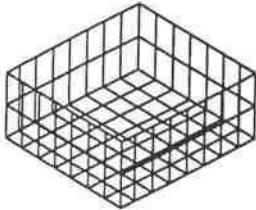
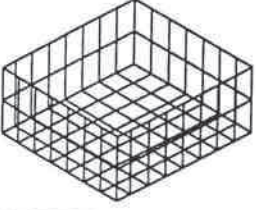
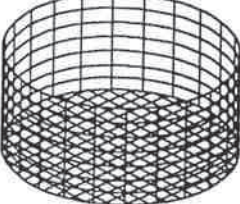
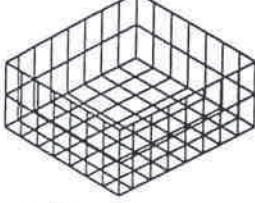
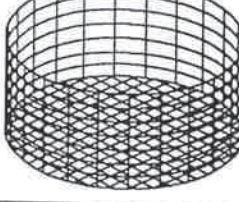
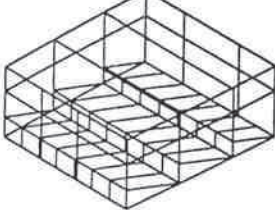
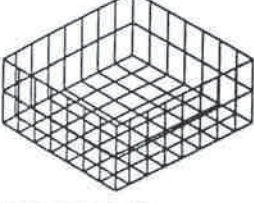
TAVOLA
DO

CODICE	DESCRIZIONE	CESTO	MODELLO APPARECCHIO
2461	CESTO QUADRO SENZA ANGOLARI 350x350x115 mm		COMPACT 20 MASTER 21
3065	CESTO QUADRO SENZA ANGOLARI 350x350x170 mm		COMPACT 20 MASTER 21
2554	CESTO TONDO Ø 330x180 mm		COMPACT 20 - MASTER 21 CON INSERTO INOX PER CESTO TONDO
630	CESTO QUADRO CON ANGOLARI 350x350x170 mm		MINIBAR CF - GEMINI CF PROGRAM 25 CF - IDROJET CF
195	CESTO TONDO Ø 360x180 mm		MINIBAR CR - GEMINI CR ITALJET CR - IDROJET CR SNACK CR - PROGRAM 25 CR PROJECT 28 CF CON INSERTO INOX PER CESTO TONDO
63010	CESTO QUADRO CON ANGOLARI FONDO INCLINATO A 3 DIVISORI 375x375x175 mm		MINIBAR CF - GEMINI CF PROGRAM 25 CF - IDROJET CF
63011	CESTO QUADRO CON ANGOLARI 375x375x170 mm		MINIBAR CF - GEMINI CF PROGRAM 25 CF - IDROJET CF
2814	CESTO TONDO Ø 360x240 mm		ITALJET CR - IDROJET CR SNACK CR - PROGRAM 25 CR

CESTI PER LAVABICCHIERI E LAVAPIATTI

TAVOLA
DT

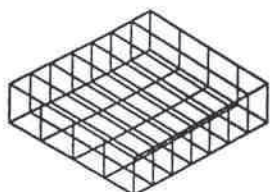
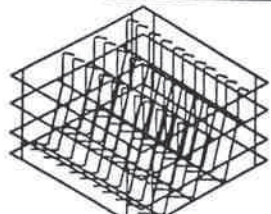
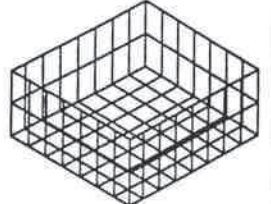
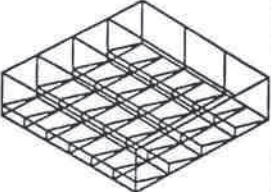
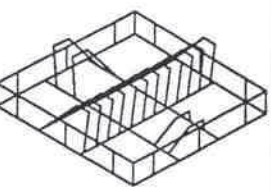
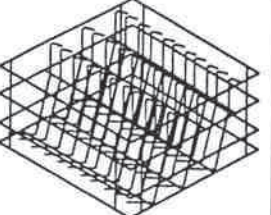
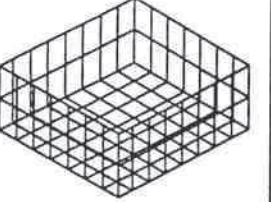
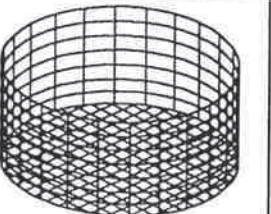





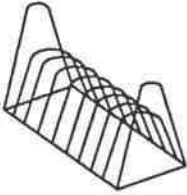
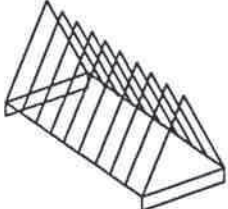
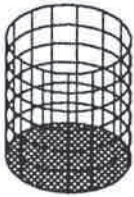
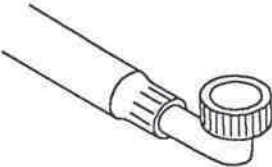
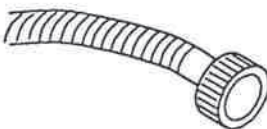
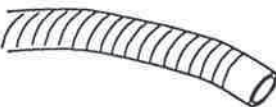
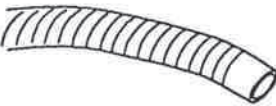



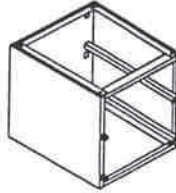
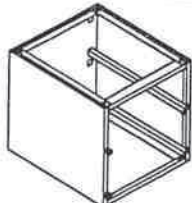
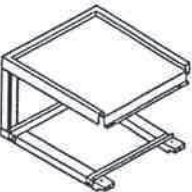

CODICE	DESCRIZIONE	CESTO	MODELLO APPARECCHIO
628	CESTO QUADRO CON ANGOLARI A 7 DIVISORI 380x380x100 mm		PROGRAM 25 CF
398	CESTO QUADRO CON ANGOLARI PER CALICI 380x380x200 mm		PROGRAM 25 CF
2145	CESTO QUADRO CON ANGOLARI 400x400x150 mm		PROJECT 28
2539	CESTO QUADRO CON ANGOLARI FONDO INCLINATO A 4 DIVISORI 400x400x150 mm		PROJECT 28
493	CESTO 12 PIATTI 400x400x120 mm		PROJECT 28
375	CESTO QUADRO CON ANGOLARI PER CALICI 400x400x200 mm		PROJECT 28
377	CESTO QUADRO CON ANGOLARI 400x400x250 mm		PROJECT 28
2778	CESTO TONDO Ø 400x170 mm		PROJECT 28 CON INSERTO INOX PER CESTO TONDO

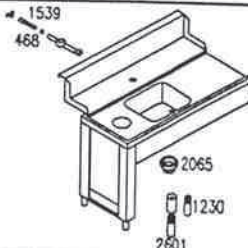
ACCESSORI IN DOTAZIONE

TAVOLA
DI

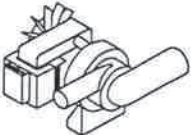
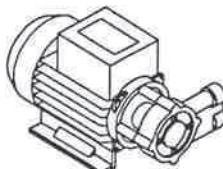
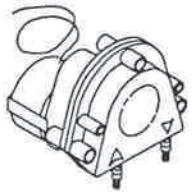
CODICE	DESCRIZIONE	CESTO	MODELLO APPARECCHIO
186	INSERTO PORTAPIATTINI A 12 POSTI		COMPACT 20 - MASTER 21 MINIBAR - GEMINI PROGRAM 25 - PROJECT 28 ITALJET - IDROJET SNACK
187	INSERTO PORTAPIATTINI A 15 POSTI		SELF 2 - SELF 4.32 GL 5.34 - GL 7.38
189	INSERTO PORTAPOSATE		IN TUTTI I MODELLI
139	CANNA DI CARICO CON CURVA 1500 mm		COMPACT 20 - MASTER 21 MINIBAR - GEMINI PROGRAM 25 - PROJECT 28 SELF 2 - SELF 4.32 GL 1040 - GL 1240
253	CANNA DI CARICO SENZA CURVA 1500 mm		SELF 4.32 GL 5.34 - GL 7.38
638	CANNA DI SCARICO ø18x2000 mm		COMPACT 20 - MASTER 21 MINIBAR - GEMINI PROGRAM 25 - ITALJET IDROJET - SNACK
2188	CANNA DI SCARICO ø28x2000 mm		PROJECT 28 SELF 2 - SELF 4.32 GL 500 - GL 700 GL 5.34 - GL 7.38 GL 1040 - GL 1240

OPTIONAL

INSERTO INOX PORTACESTI		CODICE	INSERTO INOX PORTACESTI		CODICE
	COMPACT 20 MASTER 21 MINIBAR-GEMINI	595190 595190 595290		PROGRAM 25 PROJECT 28 SELF 4.32	595290 595390 595490
BASAMENTO PORTACESTI		CODICE	BASAMENTO PORTACESTI		CODICE
	COMPACT 20 MASTER 21 MINIBAR GEMINI	591990 592090 592690 592690		PROGRAM 25 PROJECT 28 SELF 4.32 GL 5.34	592990 592790 592490 592390
PIANO DI SGOMBERO PER GL 1040-1240		CODICE	LAVELLO PER GL 5.34 DX-SX (CON RUBINETTO E PORTA)		CODICE
	L = 700 mm P = 566 mm H = 450 mm	590990		L = 1200 mm P = 700 mm H = 850 mm	DX 590790 SX 590890
TAVOLO PRELAVAGGIO DX-SX DA 1500 mm PER GL 1040-1240		CODICE	TAVOLO PRELAVAGGIO DX-SX DA 1200 mm PER GL 1040-1240		CODICE
	DX SX	590390 590490		DX SX	590590 590690
	GOMMA ANTIURTO PIEDE BANCALE PVC PIEDE BANCALE INOX PARTICOLARE FISSAG. DOCCIONE DADO DOCCIONE PRELAVAGGIO	2065 1230 2601 1539 468		PIEDE BANCALE PVC PIEDE BANCALE INOX PARTICOLARE FISSAG. DOCCIONE DADO DOCCIONE PRELAVAGGIO	1230 2601 1539 468
DOCCIONE COMPLETO		CODICE	PATTUMIERA CON RUOTE		CODICE
		594290			594190
POMPA DI SCARICO		CODICE	POMPA SUPPLEMENTARE		CODICE
		379			380
DOSATORE DETERSIVO		CODICE	DEPURATORE		CODICE
		1206		8 Lt. 12 Lt. 16 Lt. 20 Lt.	596190 596290 596390 596490
INSERTO PORTACALICI		CODICE	INSERTO PORTABICCHIERI INCLINATO		CODICE
		2144			2252

DOSATORE BRILLANTANTE

TAVOLA
DB

DOSATRON

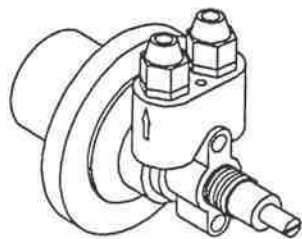

60

- | | | | | | |
|------|---|--|--|---|------|
| 2450 | — | | | — | 2450 |
| 2453 | — | | | — | 2453 |
| 1136 | — | | | — | 1136 |
| 2245 | — | | | | |
| 2217 | — | | | — | 2217 |
| 2504 | — | | | | |
| 2446 | — | | | — | 2446 |

- | | |
|------|-----------------------|
| 1136 | OR 3056 |
| 2217 | SFERA 3/8 INOX |
| 2245 | MOLLA CONICA INOX |
| 2446 | OR 2025 |
| 2450 | SERRATUBO |
| 2453 | TAPPO VALVOLA |
| 2504 | DISTANZIATORE |
| 634 | VALVOLA A LABBRO |
| 2560 | SEDE VALVOLA A LABBRO |

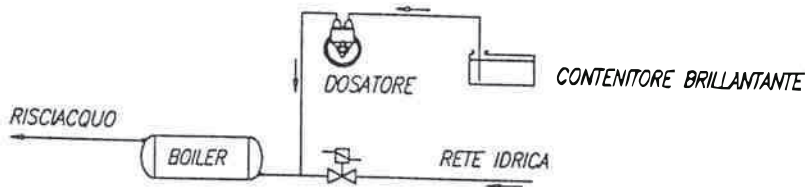
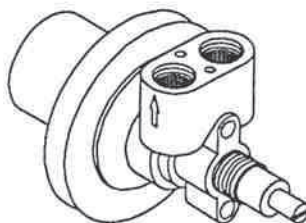

SCHEMA DI COLLEGAMENTO

DOSATORE BRILLANTANTE "DOSATRON"

CARATTERISTICHE TECNICHE

FUNZIONAMENTO: utilizza la pressione di risciacquo della macchina.

COLLEGAMENTO IDRICO: utilizzare la cannucia installata nella macchina per collegare il dosatore lato "freccia uscita" all'impianto di risciacquo della lavastoviglie nel tratto compreso fra l'elettrovalvola e il boiler. Con la cannucia in dotazione collegare il dosatore lato "freccia entrata" al contenitore di brillantante.

FISSAGGIO MECCANICO: utilizzare il dado in dotazione. N.B. il dosatore puo' avere qualsiasi orientamento di montaggio.

INNESCO: procedere nel seguente modo: svitare la vite di regolazione fino all'arresto, quindi spingerla all'interno piu' volte affinche' il brillantante aspirato riempi entrambe le cannuce.

REGOLAZIONE: ad ogni risciacquo inietta una quantita' di brillantante regolabile da 0 a 4 cm³, equivalente ad una lunghezza aspirata della cannucia da 0 a 30 cm. La portata nulla si ha avvitando completamente la vite di regolazione (senso orario), mentre la portata massima si ottiene con la vite svitata di circa 13 giri (senso antiorario). Per ogni giro della vite la dose varia di 2cm aspirati in cannucia (0.3 cm³/giro).

Seite	Kredtor Artikel Nr.	IT
001	00000001	DEVIATORE 16 AMPERE
001	00000071	LAMPADA SPIA 230V
001	00000120	MORSETTIERA 3 POLI
001	00000134	PIEDINO REGOLABILE LAVAB. - LAVAST.
001	00000157	ASS. GALLETTO FIX ALBERINO CR
001	00000186	INSERTO PORTAPIATTINI 12 POSTI
001	00000189	INSERTO NYLON X POSATE
001	00000195	CESTO RETE D. MM360X180H
001	00000359	TERMOSTATO DA 0 A 90o PER LAV.
001	00000364	INTERRUTTORE LUMINOSO 230V
001	00000630	CESTO RETE 375X375X130mm C/ANG
001	00001083	LAMPADA SPIA VERDE TONDA 230V
001	00001146	PULSANTE ALENTE GIALLA 230V
001	00001177	Filtro inox
001	00001623	TIMER A PULSANTE 120' 230V 50Hz
001	00001689	MICROINT. SENZA ROTELLA
001	00001703	SQ. ARRESTO FERMO PORTA COMPACT - GEMINI - PROGRAM
001	00001714	VITE INOX FIX PORTA MPSX CORTA
001	00001718	ASS. PORTA GEMINI/PROGRAM 25
001	00001724	ASS. ALBERINO INOX COMPLETO PROGRAM/GEMINI CR
001	00001895	PANN. COM. SERIG. PROGRAM/25
001	00002194	ASS. CRICCO PORTA
001	00002217	SFERA 038 INOX 420C 200G
001	00002223	MOLLA CILINDRICA INOX DIS.636
001	00002247	CILINDRO PER CRICCO PORTA
001	00002372	PANN. COM. SERIG. PROGRAM/25
001	00002379	PANN. ELETT. CABLATO PROGRAM25
001	00002385	Assieme carrozzeria per CF
001	00002404	PANN. SOTTOPORTA PROGRAM/25
001	00002405	BASAMENTO PROGRAM/25
001	00002407	CAMICIA INOX PROGRAM/25
001	00002408	PANN. POSTERIORE PROGRAM/25
001	00002496	DEVIO PULSANTE 10A.F.P/POM.SCA
001	00002651	ASS. MICRO TELE.
001	00002670	PASTIGLIA MM9.5X2 BLOCCAPORTA
001	00002742	ASS. SUPP. MICRO TELESCOPICO
001	00002756	SPINA MICRO TELESCOPICO
001	00035110	PRESSOSTATO LIVELLO 55/30 LAVAST.
001	00063011	CESTO RETE MM375X375X170 C/ANG
001	00126010	ANGOLARE MANIGLIA SX
001	00126011	ANGOLARE MANIGLIA DX
001	00179011	ASS. VOLANTINO INOX CESTO ROTANTE
001	00224710	DADO FIX CRICCO PORTA - MICRO TEL.
001	00224711	PART. OTT. CHIUSURA PORTA
003	00000025	OR 128
003	00000057	OR PER FLANGIA
003	00000060	DOSATORE BRILLANTANTE A PRESSIONE DI RETE (60)
003	00000093	OR 121
003	00000108	PILETTA SCARICO G3/4
003	00000109	GUARNIZIONE GOMMA 45x26x1.5mm
003	00000110	DADO PILETTA G3/4
003	00000123	OR 115
003	00000124	GUARNIZIONE 25x17x2mm
003	00000125	DADO G3/8 CROMATO
003	00000139	TUBO CARICO MM1500 C/CURVA
003	00000161	TUBO SAGOMATO A 'S' DIS.205
003	00000162	FASCETTA MEB 9 32-50 M032 TOP Q
003	00000166	CONDENSATORE 10 æF CON CODOLO
003	00000206	ASS. GABBIA D'ARIA PROGRAM 25 - FINITO
003	00000207	GUARNIZIONE 19x10x2mm
003	00000246	Spezzone tubo gomma 12x17x900
003	00000267	DADO M10 X 1 OTTONE
003	00000312	RESISTENZA 220V 2000W
003	00000394	ELETTRORVALVOLA SING. 90o 230V
003	00000403	CAPPUCCIO PER CONDENSATORE 5 MICROF
003	00000612	FERMACAVO
003	00000638	TUBO SCARICO øint 18 x 2000mm
003	00000697	OR 112
003	00000700	COLLETORE GOMMA TELATA GEMINI L=0,050 MT

Seite	Kreditor Artikel Nr.	IT
003	00000706	COLLARE POMPA GOMMA MM30
003	00001133	VITE GODRONATA VER. INOX DIS.406
003	00001171	FULCRO OTT. RISCIAQUO
003	00001173	RONDELLA TEFLON 16X10X2mm
003	00001183	OGIVA TEFLON DA 12X3/8'
003	00001184	DADO OTT. MM12X3/8'
003	00001209	STAFFA BLOCCAGGIO FLAN. BOILER
003	00001313	TUBO GOMMA MM12X17X230 MINIBAR
003	00001324	RESISTENZA 220V 2000W
003	00001334	PRESSINO COMP. M/1400-900
003	00001481	Tube gomma 12x17x120 mm
003	00001556	CAVO ALIMENTAZIONE 3X2.5X2500
003	00001629	POMPA LAVAGGIO 0.25 HP V230M 50Hz ROTAZIONE ORARIA
003	00001633	OR 147
003	00001669	UGELLO RISCIAQUO DIS.333
003	00001695	CONCHIGLIA NYLON
003	00001697	FULCRO INOX CROCERA DA COMPACT 20 A PROGRAM 25
003	00001698	FASCIA COIBENTAZIONE BOILER PROGRAM
003	00001699	ASS. BOILER 3L GEMINI-PROGRAM/25
003	00001711	RAMPA ALIMENTAZIONE RISCIAQUO GEMINI/CF PROGRAM/CF
003	00001712	ASS. GIRELLO RIS.
003	00002128	CURVA INOX d.12mm-78g.
003	00002199	TROPPOPIENO INOX COMPACT - GEMINI - PROGRAM
003	00002265	BUSSOLA CARBOGRAFITE GIRANTE
003	00002294	DADO X TIRANTE DIS.470
003	00002410	RACC. RAME RIS. PROGRAM/CF
003	00002450	SERRATUBO DIS.506
003	00002478	PILETTA SCARICO OTTONE
003	00002502	TAPPO GIRELLO RISCIAQUO
003	00002503	PRESA DI PRESSIONE
003	00002531	OR 106
003	00002650	TAPPO PLASTICA BRACCI LAVAGGIO ø25
003	00002654	MOLLA AD ARCHETTO BRACCIO LAVAGGIO ø25
003	00002733	DISTANZ. FULCRO INOX
003	00002762	ASS. CROCERA LAV. RIS. LAVABICCHIERI - SML 2
003	00002763	ASS. FLANGIA BOCCAGLIO INOX
003	00214711	DISTANZIALE OTT. RISCIAQUO PROGRAM
003	00241110	RACCORDO RAME PER BOILER mm 180
005	00000630	CESTO RETE 375X375X130mm C/ANG
005	00063010	CESTO RETE MM375X375X175 C/ANG
005	00063011	CESTO RETE MM375X375X170 C/ANG
006	00000628	CESTO A SBARRE MM375X375
006	00000398	CESTO X CALICI MM380X380 PROG.
007	00000186	INSERTO PORTAPIATTINI 12 POSTI
007	00000189	INSERTO NYLON X POSATE
007	00000139	TUBO CARICO MM1500 C/CURVA
007	00000638	TUBO SCARICO øint 18 x 2000mm
008	00594290	DOCCIONE COMPLETO
008	00000379	POMPA DI SVUOTAMENTO 230V 50Hz
008	00001206	KIT DOSATORE DETERS. FISSO 230V 50Hz 1,5 litri/h
008	00002144	INSERTO PORTACALICI (NR.5 FLUTES)
008	00595290	INSERTO INOX PORTACESTI
008	00595390	INSERTO INOX PORTACESTI
008	00595490	INSERTO INOX PORTACESTI
008	00592990	TAVOLO PRELAVAGGIO DX, DA 1500 mm; PER AL 1500
008	00592790	BASE INOX PORTACESTI
008	00592490	BASAMENTO PORTACESTI
008	00592390	BASAMENTO PORTACESTI
008	00594190	PATEUMIERA CON RUOTE, ø=400mm, H=465mm, CAPIENZA=58 Lt.
008	00000380	POMPA SUPPLEMENTARE 230V 50Hz
008	00596190	DEPURATORE 8 Lt
008	00596290	DEPURATORE 12 Lt.
008	00596390	DEPURATORE 16 Lt.
008	00596490	DEPURATORE 20 Lt.
008	00002252	INSERTO BICCHIERI PROJECT/28
009	00001136	OR 3056
009	00002217	SFERA 038 INOX 420C 200G
009	00002245	MOLLA INOX CONICA
009	00002446	or 2025

Seite	Kreditor Artikel Nr.	IT
009	00002450	SERRATUBO DIS.506
009	00002453	TAPPO VALVOLA DOSAT. ARISTARCO
009	00002504	DISTANZ. DOSAT. ARISTARCO DIS.546
009	00000634	VALVOLA X DOSATORE
009	00002560	SEDE VALVOLA A LABBRO PER DOS.