



















































































 <b>smeg</b> s.p.a. Via Ciconvallegazione Nord, 36 42016 Guastalla (RE)	FORM. A4	LA RIPRODUZIONE O LA CESSIONE DEL PRESENTE DISEGNO DEVONO ESSERE AUTORIZZATE DALLA SMEG S.p.A. ANY REPRODUCTION OR TRANSFER OF THE PRESENT DRAWING MUST BE AUTHORIZED BY "SMEG" S.p.A.	MODELLO - MODEL <b>ALFA135XV</b>	CODICE - ART.NO. <b>570090 - A</b>	VERSIONE - EDITING <b>01 del 14.02.2000</b>
--	----------	---	-------------------------------------	---------------------------------------	--

RefNum	Codice	Qtà	Descrizione	DISP	€	Data ingr.	Data uscita	IN	OUT	Carrello	E
 2412	824610038	1	LAMPADA X GEMMA 59261T	 		2,14	14-02-2000	21-03-2001			
 3092	825170029	1	MORSETTIERA 5 POLI+TERRA EI404			5,45	14-02-2000			1	
 3100	765170037	1	MORSETTO FISSACAVO 6055			0,48	14-02-2000	15-12-2005			
 3100	760212217	1	PASSACAVO ALFA200X			0,68	16-12-2005				
 6062	895090067	1	MOLLA PER MANOPOLE			0,13	14-02-2000			1	
 6904	760210075	1	ANELLO TENUTA PULSANTE S24/A			0,48	14-02-2000			1	
 9532	763870038	1	GEMMA VERDE SPIA IFSCP22MTFR			0,73	14-02-2000	16-12-2001		1	
 10483	763870044	1	GEMMA ARANCIO SPIA GEMB			1,22	14-02-2000	16-12-2001		1	
 13045	764970807	1	MANOPOLA COMMUTATORE BRTL GW3000			0,84	14-02-2000			1	
 13259	844090261	2	GRIGLIA DEFLETTORE S94			2,29	22-03-2001			1	
 16728	816850105	2	CONTATTORE MC1A400AH6	 		29,53	14-02-2000	22-04-2004			
 16728	816850242	2	CONTT MC1A400AT6 ALFA200X			38,44	23-04-2004				
 17964	754130475	1	GUARNIZIONE 4 LATI MARRONE S890			9,73	14-02-2000	11-03-2001			
 17964	754131105	1	GUARNIZIONE FACCIATA FORNO ALFA135X			6,60	12-03-2001				
 17972	0C2810223	1	DISTANZIALE VETRO FORNO S890			13,72	14-02-2000	06-01-2002		1	
 17975	754130476	1	GUARNIZIONE VETRO INTERNO MARRONE S890			3,41	14-02-2000	06-01-2002		1	
 17976	754130477	1	GUARNIZIONE SUPERIORE DISTANZIALE MARRONE S890	 		0,98	14-02-2000				
 17981	931330249	1	CERNIERA DESTRA PORTA FORNO S890			6,37	14-02-2000	31-01-2002			
 17981	931330808	1	CERNIERA PORTA FORNO SINISTRA ALFA135			4,79	01-02-2002				
 17982	931330250	1	CERNIERA SINISTRA PORTA FORNO S890			6,37	14-02-2000	31-01-2002			
 17982	931330807	1	CERNIERA PORTA FORNO DESTRA ALFA135			4,79	01-02-2002				
 18720	824610129	1	LAMPADA VERDE FASTON M DOA1			2,35	14-02-2000	16-12-2001			
 18720	824610596	1	LAMPADA SPIA VERDE ALFA151X			1,19	17-12-2001				
 19162	767210015	2	RONDELLA DIAMETRO 4 IN FIBRA			0,10	14-02-2000			1	
 20391	766330345	1	PROTEZIONE CABLAGGIO S400			1,14	14-02-2000			1	
 20419	682370794	1	SOTTOGRUPPO CORNICE FORNO S20XMF/R			138,83	14-02-2000	24-02-2005			
 20419	682371641	1	STG CORN ALFA135XV GRUPPO			79,40	25-02-2005				

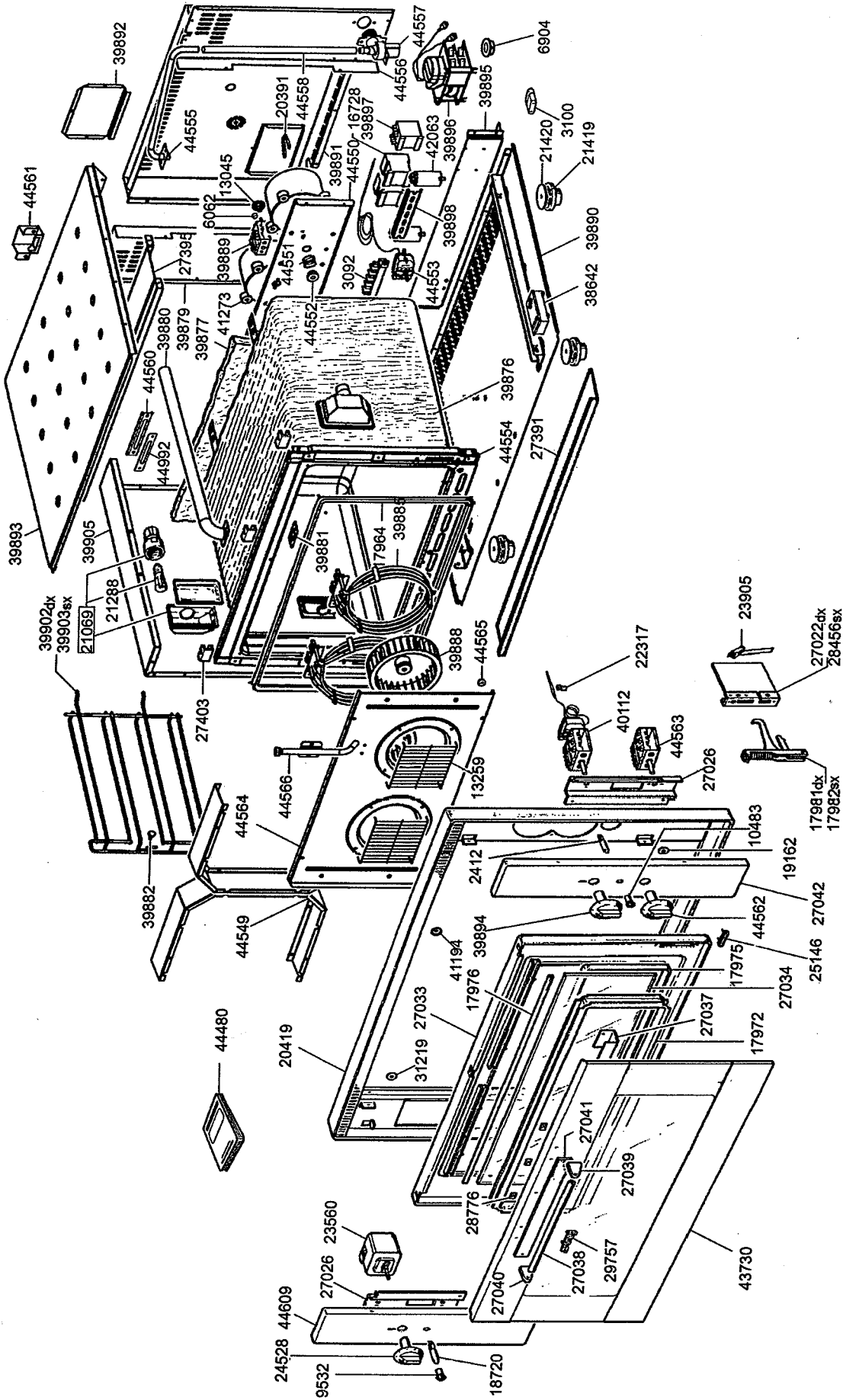

**smeg** S.p.A  
 Via Circonvallazione Nord, 36  
 42018 Guastalla (RE)

FORM. A4

LA RIPRODUZIONE O LA CESSAZIONE DEL PRESENTE DISEGNO DEVONO ESSERE AUTORIZZATE DALLA "SMEG" S.p.A.  
 ANY REPRODUCTION OR THE TRANSFER OF THE PRESENT DRAWING MUST BE AUTHORIZED BY "SMEG" S.p.A.

MODELLO - MODEL  
**ALFA135XV**

CODICE - ART.N.  
**570090 - A**

VERSIONE - EDITING  
**01 del 14.02.2000**

	21069	696050050	2	PORTALAMPADA VOLT 220 ALFA10		17,36	14-02-2000			1	
	21288	824610204	2	LAMPADA X ALFA 10		3,60					
	21419	760330044	4	ATTACCO PIEDINI REGOLABILI S514X		0,61	14-02-2000			1	
	21420	897210256	4	RONDELLA PER PIEDINO S514X		0,52	14-02-2000			1	
	22317	895090304	4	MOLLETTA FISSAGGIO BULBO ALFA10		0,18	14-02-2000			1	
	23300	893210127	2	FASCETTA A VITE DIAMETRO 15		1,73	03-06-2003				
	23300	893210343	2	FASCETTA A VITE D.12-20		0,00	04-06-2003				
	23560	818800079	1	TIMER ELETTRONICO 1 ORA ALFA25		36,88	14-02-2000			1	
	23905	814490182	1	MICRO PER PORTA S300		6,01	14-02-2000			1	
	24528	764971805	1	MANOPOLA TIMER ALFA30		2,53	14-02-2000			1	
	25146	058450199	1	TAPPO FORI MARCHIO N522TGI		1,84	14-02-2000	24-02-2005			
	27022	685970024	1	SOTTOGRUPPO PORTARULLO DESTRO ALFA100		4,32	14-02-2000	22-04-2001			
	27022	685970043	1	SOTTOGRUPPO PORTARULLO ALFA135X		4,27	23-04-2001				
	27026	018411457	2	SUPPORTO COMANDI ALFA100X		10,81	14-02-2000			1	
	27033	352050338	1	STG CONTROPORTE FORNO MARRONE S890MFR		36,04	14-02-2000	31-03-2000			
	27033	352050598	1	STG CONTROPORTE FORNO MARRONE ALFA135X		17,59	01-04-2000	06-01-2002			
	27033	682050676	1	STG CONTROPORTE MARRONE ALFA135XV		39,72	07-01-2002				
	27034	772530846	1	VETRO INTERNO PORTA ALFA100X		20,18	14-02-2000			1	
	27037	018290227	1	STAFFA SUPPORTO MANIGLIA ALFA100X		9,37	14-02-2000				
	27038	174930451	1	MANIGLIA PORTA FORNO ALFA100X		9,52	14-02-2000			1	
	27039	878411458	1	SUPPORTO DESTRO MANIGLIA ALFA100X		5,40	14-02-2000			1	
	27040	878411459	1	SUPPORTO SINISTRO MANIGLIA ALFA100X		5,40	14-02-2000			1	
	27041	764851396	1	LISTELLO RIPARO MANIGLIA ALFA100X		1,80	14-02-2000			1	
	27042	695410488	1	GRUPPO PANNELLO LATERALE COMANDI ALFA100X		16,85	17-01-2002				
	27042	695411277	1	GRUPPO PANNELLO COMANDI DESTRO ALFA151X		9,00	18-01-2002				
	27391	014851395	1	LISTELLO PROTEZIONE MATERASSINO ALFA100X		4,32	14-02-2000	23-10-2002			
	27395	018930513	1	TRAVERSA SOSTEGNO CARTER ALFA100X		12,99	14-02-2000				

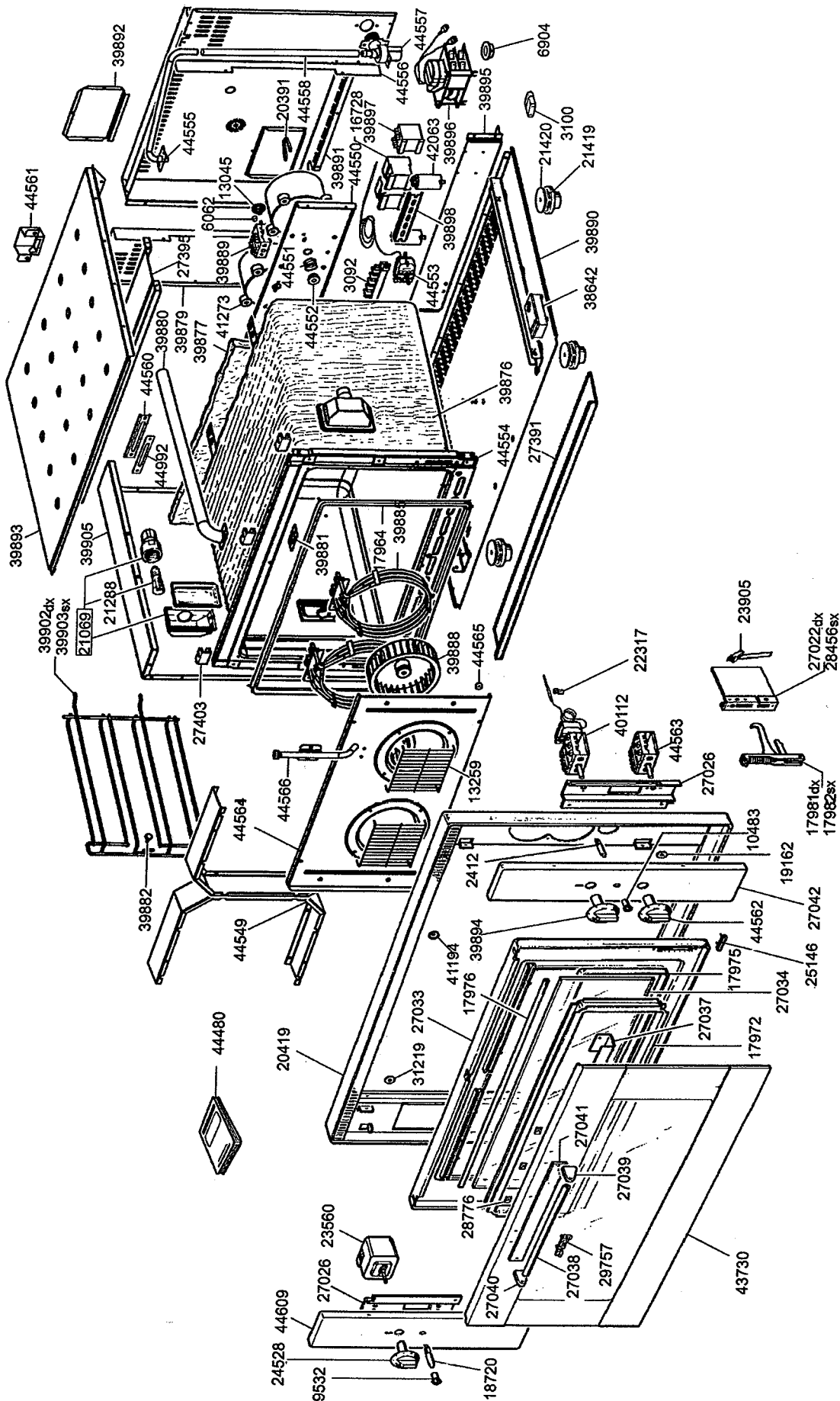

**smeg** s.p.a  
 Via Circonvallazione Nord, 36  
 42016 Giustalla (RE)



























































































FORM. A4

LA RIPRODUZIONE O LA CESSIONE DEL PRESENTE  
 DISEGNO DEGRADAZIONE E' AUTORIZZATA DALLA  
 SMIEG S.P.A.  
 ANY REPRODUCTION OR TRANSFER OF THE  
 PRESENT DRAWING MUST BE AUTHORIZED BY  
 SMIEG S.P.A.

MODELLO - MODEL  
**ALFA135XV**

CODICE - ART.NO.  
**570090 - A**





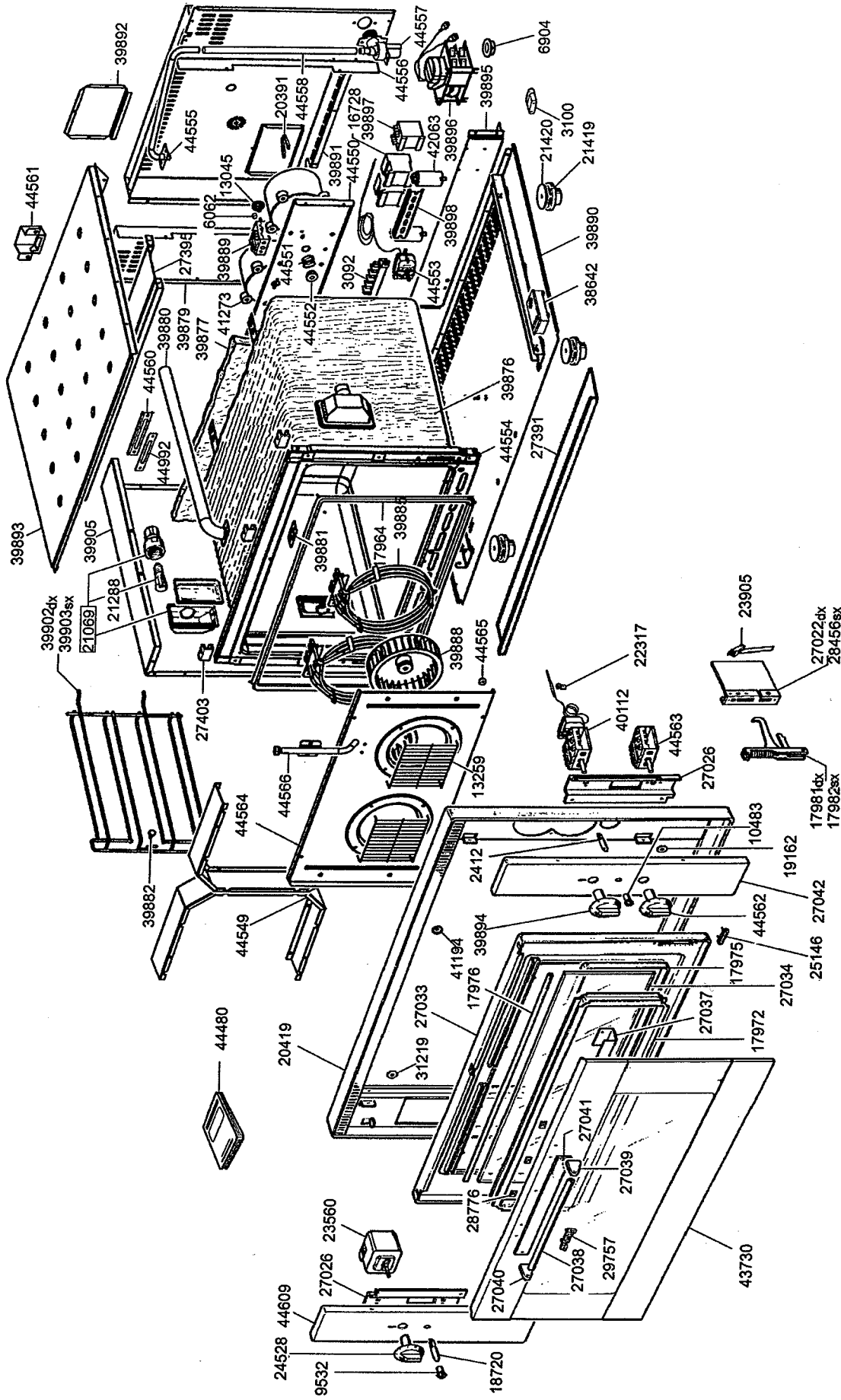













































































VERSIONE - EDITING  
**01 del 14.02.2000**

	27403	018250431	5	SQUADRETTA CARTER SUPERIORE ALFA100X	 	3,98	14-02-2000	
	28456	685970027	1	SOTTOGRUPPO PORTARULLO SINISTRO S890		2,27	14-02-2000	 1 
	28635	695050128	1	GRUPPO MATERASSINO FILTRO S200		1,44	19-12-2003	 1 
	28636	818730424	1	TERMOSTATO RESISTENZA 70°C S200		5,76	23-03-2000	 1 
	28776	895730310	3	PIASTRINA PER PERNI PL-4159		0,10	14-02-2000	 1 
	29757	925030057	1	MARCHIO SMEG ALFA100X		2,88	14-02-2000	 1 
	31219	764130572	2	GUARNIZIONE FIBRA DE10.DI5.SP1		0,15	14-02-2000	 1 
	38642	817620004	1	SFGNALATORE ACUSTICO ALFA30		14,88	14-02-2000	 1 
	39876	695050165	1	GRUPPO MATERASSINO INVOLUCRO ALFA135X		22,65	14-02-2000	 1 
	39877	695050164	1	GRUPPO MATERASSINO RETRO ALFA135X		11,64	14-02-2000	 1 
	39879	018412014	1	SUPPORTO POSTERIORE SINISTRO ALFA135X		11,00	14-02-2000	 1 
	39880	688971671	1	SOTTOGRUPPO TUBO SCARICO VAPORE ALFA135X		34,29	14-02-2000	 1 
	39881	063490055	1	FLANGIA SCARICO VAPORE ALFA135X		2,51	14-02-2000 22-10-2002	 1 
	39882	178412010	2	SUPPORTO TELAI ALFA135X		5,51	14-02-2000	 1 
	39885	806890378	2	RESISTENZA VENTOLA WATT 2600 ALFA135X		22,65	14-02-2000	 1 
	39888	069290070	2	VENTOLA D.155X38SS ALFA135X		66,80	14-02-2000	 1 
	39889	811730166	1	COMMUTATORE RESISTENZA ALFA135X		9,71	14-02-2000	 1 
	39890	681090661	1	STG CARTER INFERIORE ALFA135X		48,52	14-02-2000	 1 
	39891	011090658	1	CARTER POSTERIORE ALFA135X	 	32,35	14-02-2000	
	39892	012171507	1	COPERCHIO MORSETTIERA ALFA135X		7,78	14-02-2000	 1 
	39893	061090659	1	CARTER SUPERIORE ALFA135X		41,84	14-02-2000	 1 
	39894	764972639	1	MANOPOLA COMMUTATORE FORNO ALFA135X		2,28	14-02-2000 16-12-2004	
	39894	764975392	1	MNOP COMM ALFA41		2,43	17-12-2004	
	39895	018412011	1	SUPPORTO COMPONENTI ALFA135X		19,42	14-02-2000 07-02-2002	



 smeg s.p.a. Via Ciconvallazione Nord, 36 42016 Guastalla (RE)	 FORM. A4	 LA RIPRODUZIONE DI QUESTA PAGINA È PERMESSA SOLO SE IL DISEGNO DEVIAMO ESSERE AUTORIZZATE DALLA "SMEG" SPA. ANY REPRODUCTION OR TRANSFER OF THE PRESENT DRAWING IS AUTHORIZED BY "SMEG" SPA.	MODELLO - MODEL <b>ALFA135XV</b>	CODICE - ART.NC. <b>570090 - A</b>	VERSIONE - EDITING <b>01 del 14.02.2000</b>
--	---	--	-------------------------------------	---------------------------------------	--



	39895	018412545	1	SUPPORTO COMPONENTI ELETTRICI ALFA151X		8,14	08-02-2002	15-12-2005		
	39896	816290374	1	PROGRAMMATORE CICL 4 MIN. ALFA135X		58,23	14-02-2000			
	39897	816850187	1	RELAY BIPOLARE V.230 ALFA135X		16,19	14-02-2000	22-03-2000		
	39897	816850208	1	CONTATTORE MARRONECA022AH6		35,82	23-03-2000			
	39898	106279714	1	PROFILATO OMEGA ALFA135X		4,21	14-02-2000			
	39902	848590397	1	TELAIO DESTRO GUIDE FORNO ALFA135X			12,30	14-02-2000	24-01-2002	
	39902	844170285	1	GUIDA DESTRA FORNO 1/1GN ALFA135X		12,75	25-01-2002			
	39903	848590396	1	TELAIO SINISTRO GUIDE FORNO ALFA135X			12,30	14-02-2000	24-01-2002	
	39903	844170286	1	GUIDA SINISTRA FORNO 1/1GN ALFA135X		12,75	25-01-2002			
	39905	061090657	2	CARTER LATERALE ALFA135X		35,59	14-02-2000			
	40112	691730165	1	GRUPPO COMMUTATORE TERMOSTATO ALFA135X			20,70	14-02-2000	01-04-2004	
	40112	818731175	1	TERMO FRN ALFA31			12,07	02-04-2004		
	40112	811730241	1	COMMUTATORE FORNO INFERIORE SUK62MFX		7,11	02-04-2004			
	41194	897210255	4	ROND SOTTOV BRN D 5-SV53		0,10	22-03-2001			
	41273	795210307	2	MOTORE VENTOLA ALFA135X		112,58	14-02-2000			
	42063	811770236	2	CONDENSATORE 2,5 Mf ALFA135X		5,18	14-02-2000			
	42613	824610536	1	LAMPADA SPIA NEUTRA SE2010MF		1,23	22-03-2001	16-12-2001		
	42613	824610597	1	LAMPADA SPIA ARANCIO ALFA151X		0,95	17-12-2001			
	43730	692531169	1	GRUPPO VETRO ESTERNO PORTA ALFA135X			69,66	14-02-2000		
	44480	914771770	1	LIBRETTO ISTRUZIONI ALFA135XV			3,01	14-02-2000		
	44549	068412176	2	SUPPORTO DEFLETTORE RFT644		14,64	14-02-2000			
	44550	688412184	1	SOTTOGRUPPO SUPPORTO MOTORE RFT644		16,47	14-02-2000			
	44551	895092518	2	MOLLA BOCCOLA ALFA135XV		0,51	14-02-2000			
	44552	760570189	2	BOCCOLA ALB MTR RFT644		5,75	14-02-2000			
	44553	818731004	1	TERMOSTATO SICUREZZA RIARMO MANUALE		53,39	14-02-2000			
	44554	683690878	1	STG FORNO INOX ALFA135XV		0,00	14-02-2000			

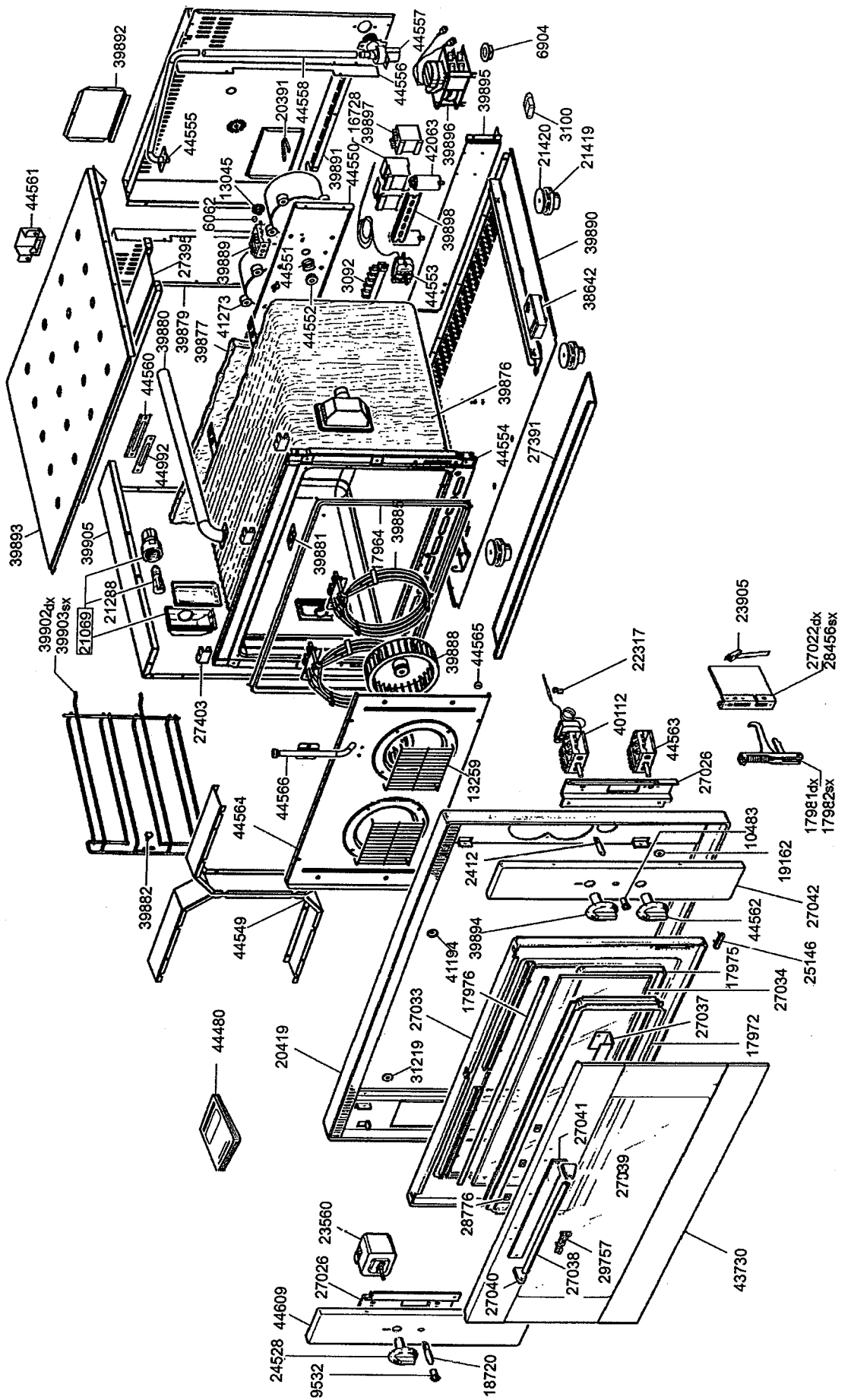

VERSIONE - EDITING  
01 del 14.02.2000





















































































CODICE - ART.N.  
570090 - A

MODELLO - MODEL  
ALFA135XV

LA RIPRODUZIONE O LA VERSIONE DEL PRESENTE  
DISEGNO DEVIAMO ESSERE  
"SMEG" S.P.A.  
ANY REPRODUCTION OR TRANSFER OF THE  
PRESENT DRAWING IS  
UNAUTHORIZED BY  
"SMEG" S.P.A.

FORM. A4

**smeg** S.p.A  
Via Circonvallazione N. 36  
42016 Guastalla (RE)

	44555	688971920	1	STG TUBO INGRANAGGIO ACQUA RFT644	 	7,93	14-02-2000	22-10-2002	
	44555	688972482	1	STG TUB INGR AQ ALFA135XV		22,66	23-10-2002		
	44556	018412175	1	SUPPORTO POSTERIORE DESTRO FRT644		11,47	14-02-2000		 1 
	44557	813050125	1	ELETTROVALVOLA ACQUA ALFA135XV		5,66	14-02-2000		 1 
	44558	758971941	1	TUBO ELETTROVALVOLA ACQUA ALFA135XV	 	4,40	14-02-2000	25-09-2002	
	44558	758971992	1	TUBO ELETTROVALVOLA ACQUA ALFA200X		2,52	26-09-2002		
	44559	754131031	2	GUARNIZIONE RESISTENZA RFT644	 	0,00	14-02-2000	09-03-2000	
	44559	784131065	2	GUARNIZIONE FLANGIA RESISTENZA ALFA135		0,95	10-03-2000		
	44560	078290429	2	STAFFA RESISTENZA RFT644	 	6,90	14-02-2000	25-06-2000	
	44560	018290452	2	STAFFA RESISTENZA ALFA135X		5,34	26-06-2000		
	44561	066330658	1	PROTEZIONE SCARICO VAPORE ALFA135X		7,93	14-02-2000		 1 
	44562	764972663	1	MANOPOLA UMIDIFICATORE ALFA200X		2,01	14-02-2000		 1 
	44563	811730194	1	COMMUTATORE UMIDIFICATORE ALFA135XV	 	7,85	14-02-2000	02-08-2001	
	44563	811730206	1	COMMUTATORE UMIDIFICATORE ALFA200X		7,54	03-08-2001		
	44564	062690173	1	DEFLETTORE RFT644		36,60	14-02-2000		 1 
	44565	060570193	2	BOCCOLA GRIGLIA DEFLETTORE RFT644	 	0,00	14-02-2000	22-10-2002	
	44566	178971919	1	TUBO ACQUA DEFLETTORE RFT644	 	6,71	14-02-2000		
	44609	695410727	1	GRUPPO PANNELLO COMANDI LATERALE ALFA130X		10,38		17-01-2002	
	44609	695411278	1	GRUPPO PANNELLO COMANDI SINISTRO ALFA151X		9,00	18-01-2002		
	44675	825170239	1	MORSETTO UNIV. 1B3-5		1,71	22-03-2001		 1 
	48364	695050219	1	GRUPPO MATERASSINO SUPPORTO MOTORE ALFA135X		1,10	08-01-2001		 1 
	49606	763890450	2	GHIERA PER GEMMA SE20XMFR1		0,63	28-09-2001	22-10-2002	 1 
	51522	696133703	1	GRUPPO PORTA FORNO ALFA135XV	 	115,72			
	51596	018413154	1	SUPP COMP ALFA161X		5,29	16-12-2005		

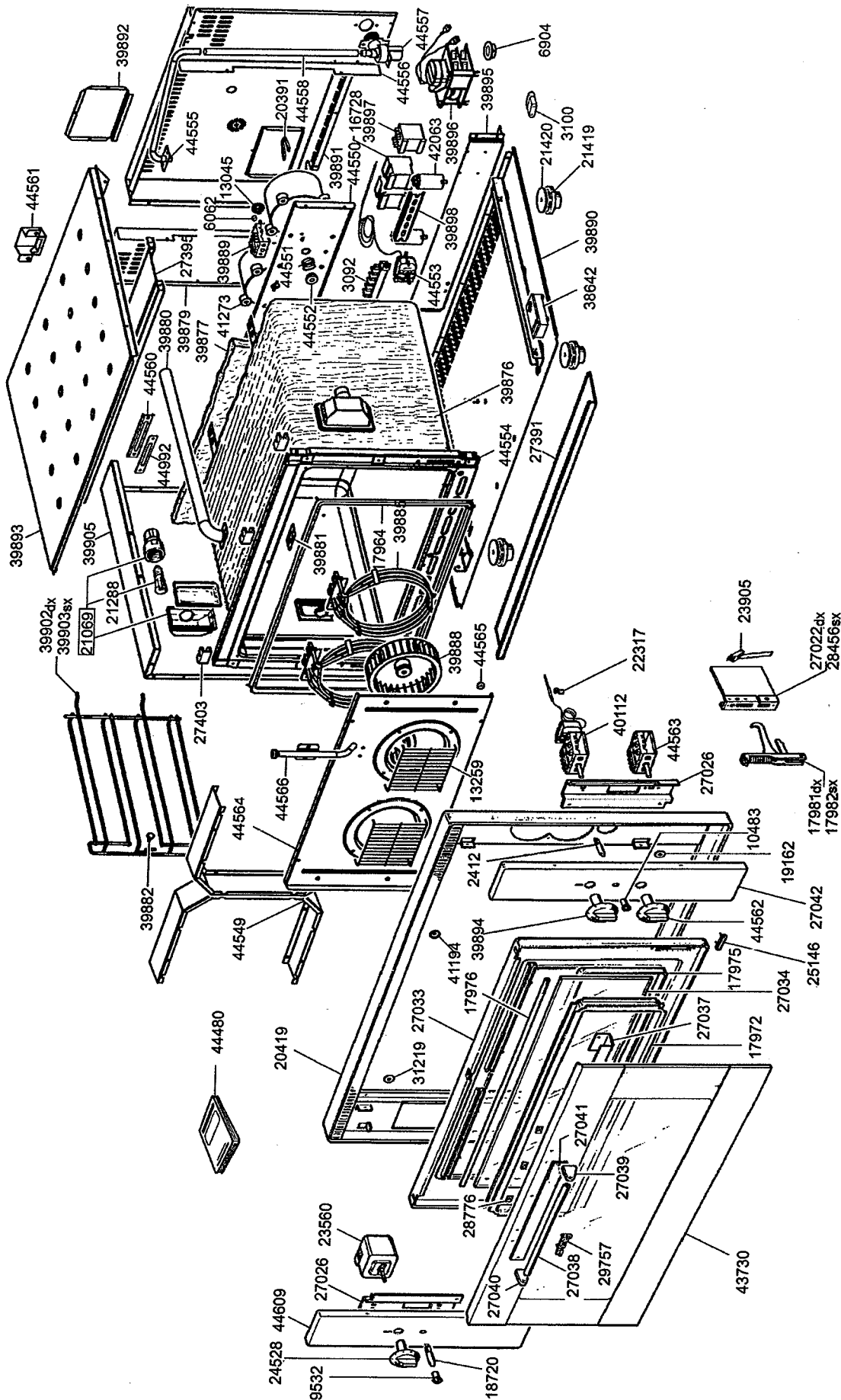

**smeg** s.p.a.  
Via Circonvallazioni Nord, 36  
42016 Guastalla (RE)

FORM. A4

LA RIPRODUZIONE O LA CESSIONE DEL PRESENTE  
DISEGNO DEVONO ESSERE AUTORIZZATE DALLA  
SMEG S.p.A.  
ANY REPRODUCTION OR TRANSFER OF THE  
PRESENT DRAWING MUST BE AUTHORIZED BY  
SMEG S.p.A.

MODELLO - MODEL  
**ALFA135XV**

CODICE - ART.N.  
**570090 - A**

VERSIONE - EDITING  
**01 del 14.02.2000**



51926

754131162 2

GUARNIZIONE  
LAMPADA  
ALFA135XV



1,30 05-04-2002

1 